

Radio- Electronics

ALL ABOUT
SCANNING RECEIVERS

\$1.25 SEPT. 1981

Amazing new products in
HOME ELECTRONICS
They're almost here

Build for your bench
SYNTHESIZED RF GENERATOR
Thumbwheel kHz selection

Expand your listening room
HI-FI ANALOG REVERB
You can build

Do it yourself
SATELLITE TV ANTENNA
It's inexpensive

Toot a tune
MUSICAL HORN
Build for your car

Explore the new frontier
100 GHz SOLID STATE DEVICES
For the experimenter

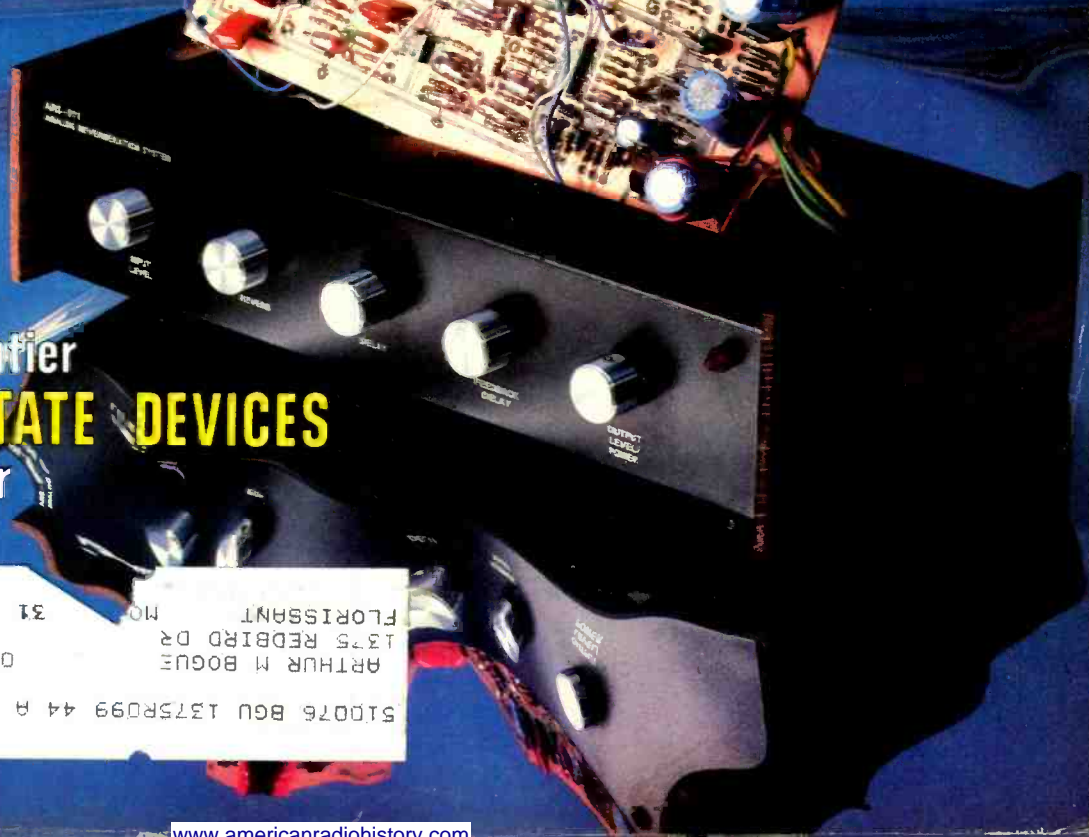
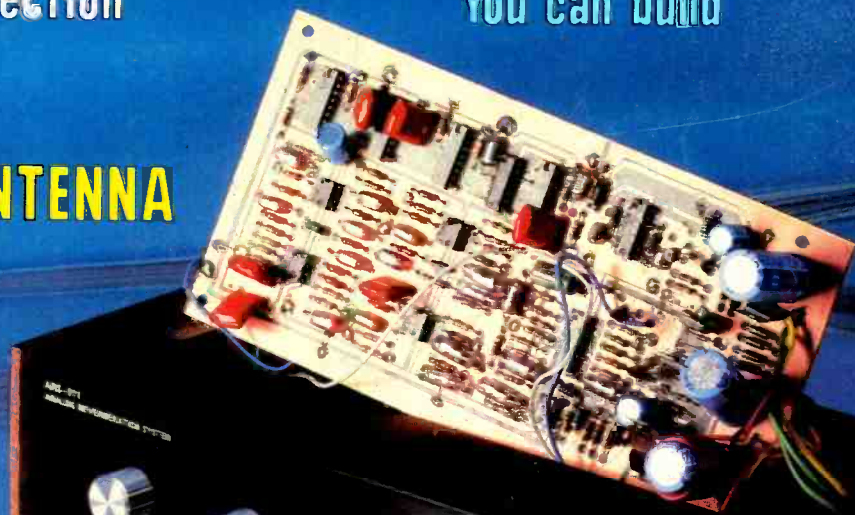

510076 BGU 1375R099 44 R MAY82
ARTHUR M BOGUE
1375 REDBIRD DR
FLORISSANT MO 63031

When you're ready to "face" the music we have a tip for reduced distortion



Whether you are seeking to reproduce the full dynamic range in the grooves of today's new superdiscs, or simply to obtain maximum listening pleasure from treasured "oldies" in your record collection, you need a phono cartridge that will deliver optimum trackability with minimum distortion.

Because the phono cartridge is the only point of direct contact between the record and your entire stereo system, its role is critical to faithful sound re-creation. That's why upgrading your phono cartridge is the single most significant (and generally least costly) improvement you can make to your stereo system.

To that end Shure now offers the Hyperelliptical Stylus Tip configuration—first introduced on the critically acclaimed V15 Type IV—in a full line of cartridges with a broad range of prices.

The Hyperelliptical Stylus Tip has been called the most significant advance in decades in tip geometry. It has a narrower and more uniform elongated contact area that results in significantly reduced intermodulation and harmonic distortion.

Look over the list at left to see which Shure HE cartridge best matches your tracking force requirements.

Shure has been the top-selling cartridge manufacturer for the past 23 years. For full details on this remarkable line of cartridges write for AL667.

The HE Family: Hyperelliptical-Equipped



V15 Type IV
¾-1¼ grams

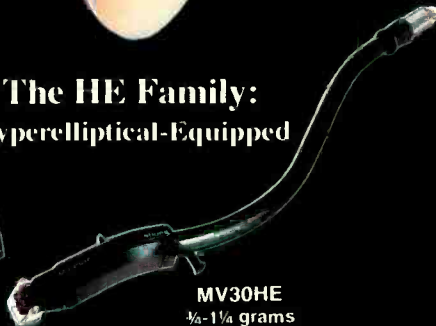

MV30HE
¾-1¼ grams



V15 LT
1¼ grams



V15 Type III-HE
¾-1¼ grams



M97HE
¾-1½ grams



M97HE-AH
(with attached headshell)
¾-1½ grams



M97 LT
1¼ grams



M95HE
¾-1½ grams



M75HE Type 2
¾-1½ grams



M75HE-J Type 2
1¼-2½ grams

Go with the leader—Shure.



Shure Brothers Inc., 222 Hartrey Ave., Evanston, IL 60204
In Canada: A. C. Simmonds & Sons Limited
Manufacturers of high fidelity components, microphones,
sound systems and related circuitry.

CIRCLE 73 ON FREE INFORMATION CARD

www.americanradiohistory.com

limited time offer
BUY FACTORY DIRECT

Entertainment 24 hours a day!

**MOVIE
STATIONS
24 HOURS**

**SPORTS
STATIONS
24 HOURS**

**NEWS
STATIONS
24 HOURS**

**180
TELEVISION
STATIONS**

**Install your personal earth station and receive
programs from all over the world.**

SKYSCAN offers the ultimate satellite earth station.

The SKYSCAN SS-6900 Satellite Earth Station is loaded with quality components designed to give years of trouble-free service. The SS-6900 is a complete package with everything you need to receive television from space.

Buy factory direct and save.

For a limited time SKYSCAN is offering the SS-6900 directly to the individual at a wholesale price. Order now and eliminate middleman commissions and mark-ups. You can afford the best system on the market today.



Only SKYSCAN offers wireless remote control.

The SKYSCAN SS-6900 is a complete package easily installed in less than 4 hours. The system includes a deluxe 3-meter antenna with base, a 120° feed horn and a 24 channel receiver in a beautiful wood-like cabinet with direct channel access, lighted channel indicators, automatic polarization switching, 70MHz down converter...and WIRELESS REMOTE CONTROL.

The SS-6900 carries a typical retail price of \$7,995. Buy factory direct and pay only

\$3,995

complete

Local sales representatives wanted.

Yes. I want to take advantage of your special offer. Please enter my order for the SKYSCAN SS-6900 Satellite Earth Station which includes everything I need to start enjoying television direct from the satellites.

Send _____ SKYSCAN SS-6900 system(s)

I enclose \$3,995, payment in full per system (Skyscan pays shipping).

I enclose 50% payment (balance C.O.D. plus shipping).

Note: 50% minimum with order; balance due on delivery plus shipping. Full payment with order: Skyscan will pay shipping—save even more.

Skyscan Corporation (consumer division)

250 E. 36th Street, Tucson, Arizona 85713 (602) 622-2261

Name _____

Address _____

City _____ State _____ Zip _____

Phone _____ Date _____

Signature _____



CIRCLE 36 ON FREE INFORMATION CARD

Sabtronics.

An entire range of low-cost, top-quality instruments.



Sabtronics revolutionized the market with the first low-cost, high-performance Digital Multimeter. Now we have an entire range of outstanding instruments in a reasonable range of prices. In fact, nobody can beat us in our price/performance ratio. And we can sell at a low price for some very good reasons. Our engineers design high performance products to be built at a low cost. And we refuse to stick on high mark ups. Plus we make sure your price stays low by selling directly to you. Because we sell so many instruments, we don't have to charge a high price. Naturally, we also offer all the helpful accessories you might want. And all our products are under warranty for good quality and high performance. In addition, you get from us the same quality aftersale service as any high priced instrument manufacturer. With Sabtronics instruments available, there's no need for you to spend a lot of money to do highly accurate testing and measuring.

2010A 3½ Digit LED DMM

2015A 3½ Digit LCD DMM

8610A 600 MHz 8-Digit Frequency Counter

8110A 100 MHz 8-Digit Frequency Counter

5020A 1Hz to 200k Hz Function Generator

8000B 1 GHz 9-Digit Frequency Counter

8610B 600 MHz 9-Digit Frequency Counter

2035A 3½ Digit LCD Handheld DMM

2037A 3½ Digit LCD Handheld DMM

*price in kit form. Also available factory assembled, tested, and calibrated. Call us for prices.

**price fully assembled, tested, and calibrated.

Call us for more information:

(813) 623-2631 (9am to 5pm EST)

Making Performance Affordable

sabtronics 
INTERNATIONAL INC.

5709 N. 50th Street Tampa, FL 33610

A. 2010A — \$99.00*, B. 2015A — \$119.00*, C. 8610A — \$119.00*, D. 5020A — \$129.00*,
E. 8000B — \$239.00**, F. 2035A — \$79.00*, G. 2037A — \$99.95*

Prices subject to change without notice.
Shipping and handling charges are \$5.00 per unit for the
2035A and 2037A/\$6.00 per unit for all other models.

SPECIAL FEATURE

- 49 HOME ELECTRONICS**
A look at some amazing new products that are almost here. **Len Feldman**

BUILD THIS

- 43 HI-FI ANALOG REVERB SYSTEM**
Attach this to your hi-fi system and expand your listening room into a concert hall. **Carl Sawtell**
- 56 MUSICAL HORN FOR YOUR CAR**
Part 2. Toot your own tune with this easy to build and install musical horn. PROM's allow you to program whatever tunes you like. **Fred Blechman and David McDonald**
- 59 SATELLITE TV ANTENNA**
Part 2. Before you receive TV signals from satellites, you need an antenna. Here's an inexpensive design using commonly available materials. **H.D. McCullough**
- 65 SYNTHESIZED RF GENERATOR**
Part 2. Construction details for a 300 kHz to 30 MHz RF generator for your workbench. **Gary McClellan**

TECHNOLOGY

- 63 SOLID-STATE MICROWAVE DEVICES**
Part 3. Explore the 100 GHz frontier with the latest solid-state devices. **Joseph J. Carr**
- 70 USEFUL TROUBLESHOOTING HINTS AND TIPS**
Several easy-to-use ideas that really work. **Elliot S. Kanter**
- 72 STATE-OF-SOLID-STATE**
An in-depth look at two useful IC's from National. **Joseph Gartman and Robert Falkner**
- 74 HOBBY CORNER**
An easy way to etch a one-of-a-kind PC board without a darkroom. **Earl "Doc" Savage, K4SDS**
- 84 NEW IDEAS**
A simple Tesla coil submitted by a reader.

VIDEO

- 4 VIDEO ENTERTAINMENT**
Tomorrow's news and products in this quickly changing field. **David Lachenbruch**
- 78 SERVICE CLINIC**
The more problems there are, the harder it is to find them. **Jack Darr**
- 79 SERVICE QUESTIONS**
R-E's Service Editor solves technician's problems.

RADIO

- 76 COMMUNICATIONS CORNER**
Speech processing can add "punch" to your signal. **Herb Friedman**

**EQUIPMENT
REPORTS**

- 27 Code-A-Phone 1000 Telephone Answering Machine**
- 33 Microconnection Computer Modem**
- 36 Grove Enterprises SW/LW Tuner**

DEPARTMENTS

- | | |
|-------------------------------------|-------------------------|
| 14 Advertising Sales Offices | 16 Letter |
| 128 Advertising Index | 98 Market Center |
| 91 Books | 94 New Lit |
| 101 Computer Market Center | 86 New Products |
| 14 Editorial | 6 What's News |
| 129 Free Information Card | |

ON THE COVER

A reverberation system adds a sense of realism to any hi-fi system by duplicating the echoes associated with large concert halls. The reverberation device described in this issue is based on analog bucket-brigade IC's and it expands your listening room into a full-sized concert hall. The construction details start on page 43.



LISTENING TO A SCANNER receiver is becoming a popular pastime. This month we look at programmable scanners starting on page 53.



3D TELEVISION is just one of the amazing products that we describe. All are close to commercial introduction. Take a close look at this and other products starting on page 49.

Radio-Electronics, (ISSN 0033-7862) Published monthly by Gernback Publications, Inc., 200 Park Avenue South, New York, NY 10003. Second-Class Postage Paid at New York, N.Y. and additional mailing offices. One-year subscription rate: U.S.A. and U.S. possessions, \$13.00. Canada, \$16.00. Other countries, \$20.50. Single copies \$1.25 © 1981 by Gernback Publications, Inc. All rights reserved. Printed in U.S.A.

Subscription Service: Mail all subscription orders, changes, correspondence and Postmaster Notices of undelivered copies (Form 3579) to Radio-Electronics Subscription Service, Box 2520, Boulder, CO 80322.

A stamped self-addressed envelope must accompany all submitted manuscripts and/or artwork or photographs if their return is desired should they be rejected. We disclaim any responsibility for the loss or damage of manuscripts and/or artwork or photographs while in our possession or otherwise.

As a service to readers, Radio-Electronics publishes available plans or information relating to newsworthy products, techniques and scientific and technological developments. Because of possible variances in the quality and condition of materials and workmanship used by readers, Radio-Electronics disclaims any responsibility for the safe and proper functioning of reader-built projects based upon or from plans or information published in this magazine.

VIDEO ENTERTAINMENT

DAVID LACHENBRUCH
CONTRIBUTING EDITOR

DIGITS AND BROADCASTING

It probably will be a long time before home television goes digital, but everything in the broadcast chain except transmission to the home could be digitized sooner than you might think. Digital VTR's already are practical, and their commercialization awaits the establishment of standards. For worldwide networking of programs, international standards committees are very close to a single standard that would make all the world's color-TV systems compatible so far as "trunk" transmission by satellite is concerned.

The preoccupation with digital television stems largely from the fact that the quality of the picture would not deteriorate with repeated taping, transmission for long distances, and other signal processing during the pre-broadcast chain of events. CBS engineers have embarked on a major program to digitize the television picture from original production virtually to the transmitter, converting it to a standard analog picture just before its transmission to homes. One of the major tasks before inter-city digital transmission becomes practical is to reduce the bandwidth required. CBS has already sliced the number of digital elements in the TV picture from 144 to 29 megabits with little sacrifice in picture and sound quality, and is working towards further reduction. CBS believes that television production in the studio can be digitized in as little as two years. It also forecasts that theatrical movies will be made with high-definition electronic digital techniques in four to five years, with a high-definition direct satellite-to-home broadcast system possible before the end of the decade.

REVOLUTIONS IN SOUND



While CBS is working towards digital TV, it's not nearly so optimistic about digital phonograph records, despite the fact that the Philips-Sony Compact Disc laser optical digital sound system is scheduled to reach the American market in 1983. CBS officials feel that digital turntables and discs will be far too expensive for the foreseeable future—perhaps 10 or 15 years—to make them mass-market products. Instead, CBS is pushing its CX (for "compatible expansion") noise-reduction system for records. CBS claims CX is completely compatible—that is, records made with the CX technique can be played satisfactorily on standard equipment, and there is an 85-dB signal-to-noise ratio when the record is played through a CX decoder. A-B comparisons with digital tape give the CX system extremely high grades, many experts being unable to tell which was which.

At press time, CBS was already releasing CX-encoded discs, and Warner Records had agreed also to use the process. Five small manufacturers were preparing to market decoders for about \$100, and CBS expects most major Japanese amplifier manufacturers to announce amplifiers with built-in decoders next January.

At the same time, many manufacturers are preparing to market the Compact Disc (CD) digital turntables. Sony, Philips, Pioneer, Matsushita (Panasonic, Quasar, Technics), Nippon Columbia (Denon), Sanyo and Mitsubishi have indicated they expect to have players on the market. Although European and Japanese record makers say they'll produce the 4.7-inch hour-per-side discs, no American record manufacturers had been heard from at press time. Turntables initially may sell for as much as \$800; discs will be priced in the high-premium area.

STEREO TV

Stereo is also the wave of the future for television. The 1982 lines in both large-screen direct-view and projection sets show an increasing preoccupation with stereo. Several brands have added stereo amplifiers and dual-speaker systems with input jacks for stereo videodiscs or TV-FM simulcasts. Those new sets, of course, will be the natural companions for the new stereo VCR's. In the next two years, we'll see increasing emphasis on television sets with stereo sound capability. While they'll be suited for stereo VCR's and stereo videodiscs (RCA will add a stereo disc player model next spring), they're actually anticipating the advent of stereo-sound telecasting here. Currently in the field-test stage, stereo TV could be approved by the FCC as early as next year. The new stereo-sound sets will require adaptors to receive stereocasts, of course—but more important to the set makers is the ability to add minor circuitry or an IC to those models and be ready when stereo TV actually starts.

R-E

Take a good look at VACO.



THE SUPER CASE
70260

The world famous Super Case. Complete with 48 of the most popular and professional problem-solving tools. From screwdrivers and nutdrivers to pliers, wrenches, crimping tools and more. A super variety and super value. All unconditionally warranted from Vaco, of course. The Super Case and all the other fine Vaco tools can be seen in our new 1981 catalog. It's free, just write. Say you want to take a good look at VACO.

Vaco Products Company, 1510 Skokle Blvd.,
Northbrook, IL 60062 U.S.A.

VACO[®]

CIRCLE 8 ON FREE INFORMATION CARD

WHAT'S NEWS

Indiana appellate court O.K.'s radar detectors

An Indiana appeals court has ruled that the State's portable police radio law does not apply to radar detectors. Enforcement of the law has been said to have been erratic over the past two years, and some motorists' radar detectors have been confiscated by the police.

The appellate decision called the law "unconstitutionally vague," and ruled that "a law forbidding or requiring conduct in terms so vague that persons of common intelligence must necessarily guess at its meaning and differ as to its application violates due process of law."

It is expected that the Indiana decision will be cited in several other state courts where police radar and scanner laws are being applied to radar detectors, even though the laws were passed before police radar existed.

British teletext group files proposal with FCC

The United Kingdom Teletext Industry Group has requested the FCC to begin a rule-making procedure to allow use of the British "defined format" teletext system in the United States. That system, widely used in Europe, is said to have two critical advantages over the rival variable-format approach. The decoders are inherently simpler and less cost-

ly, and the defined format is more resistant to disruption by multipath transmission and interference. The system proposed by the British group is also compatible with the Canadian Telidon system and with line-21 captioning for the deaf.

Teletext will allow the viewer to use his TV receiver as a newspaper, shopping guide, or educational tool.

The British group put on an extensive display of their system and equipment at the National Association of Broadcasters convention in Las Vegas last April.

Remedial reading programs available for the TRS-80

The Radio Shack Division of Tandy Corp. has entered an agreement with the Philadelphia School District to convert to the TRS-80 microcomputer two mini-computer-based reading programs developed by the Philadelphia schools for students with reading difficulties. Radio Shack will distribute the programs, known as Computer Assisted Reading Development (CARD) and Systems Approach to Basic Reading Education (SABRE).

The Philadelphia reading programs are designed to provide individualized, self-paced reading instruction, and are based on established Computer Assisted Instruction (CAI) techniques for

using computers to supplement and reinforce regular classroom instruction. They are intended to encourage positive attitudes toward learning, language, and reading in students, and to provide non-threatening, positive reinforcement in private sessions taken at the computer.

The Philadelphia system was originally developed about 10 years ago, for selected students who were reading below grade level. The programs have been improved and revised continuously since then, and researchers have recorded consistent gains as a result of their use.

The new TRS-80 reading series is expected to be available by September 1981.

"Cottage industries"

"Louise Priester," states a recent article in the New York Times "used to key-punch insurance claims into a computer in the office of Blue Cross-Blue Shield of South Carolina. Now, she does the same thing from a bedroom in her home, using a terminal connected to the office computer by the telephone line."

Thus the Times points out a new possibility for employment that can open the way for many who because of physical handicaps, young children, an invalid in the house who requires constant care, or other reasons, cannot readily leave the home. Mrs. Priester is an example: she had to stay home to take better care of her elderly mother.

One problem for employers is to control out-of-sight employees—to make sure they put in a full day's work. The very nature of the work, however, often makes it possible to operate on a piecemeal basis, as in the old cottage industries. Blue Shield of South Carolina says its four "cottage keyers" process claims at a lower cost than office keyers.

While requiring workers to be in the office during the day, the FMC Corp of Chicago has installed terminals in the homes of four programmers who are on call at night to handle problems. "They used to get a phone call," says FMC manager R. M. Copella, "hop in the car, drive 45 min-

utes to the office, solve the problem in 15 minutes, than take 45 minutes to drive home. Now they can handle most of the problems in their pajamas."

Japan to invade U.S. microcomputer market

Japan will "undoubtedly" repeat in the microcomputer market what it has done in the U.S. automobile and consumer electronics markets. Consequently, it is "inevitable" that Japanese microcomputers will be appearing in significant numbers in 1981, and that the superior Japanese quality will ultimately hurt the American manufacturers considerably more than Japanese cost-cutting.

Thus states a report, *Retailing Personal Computers*, produced and sold (for \$950.00 a copy) by Strategic Inc. of San Jose, CA.

At present, the report states, the Japanese feel that the main reason their products are not reaching the United States sooner is that FCC regulations will require that they retool to make products that meet U.S. standards (There are no RFI standards in Japan).

Hand-held models are expected to be an important new product. Tandy was first to sell this type (made by Sharp in Japan) at \$250, but Strategic Inc. expects to see Sharp, Quasar, and Panasonic models by the middle of 1981.

Incidentally, Apple, Commodore, and Radio Shack products, are all being sold in Japan. Their market is decreasing, however, because of high prices and because the Japanese microsystems offer printers with Japanese as well as English characters, something the Americans do not supply.

Tronics 2000 established in ten metropolitan markets

Ten metropolitan areas in the United States are now under development by Tronics 2000, according to R. W. Lay, Tronics' Director of Internal Operations. Tronics 2000 is a new franchising corporation that aims at giving the independent electronic-ser-

continued on page 12

Norwich Union Page 2336a

BUYING A HOUSE

1 MINIMUM COST ENDOWMENT
2 TOPPING UP LOANS
3 MORTGAGE SECURITY POLICY

Key number required

A PAGE OF BRITISH TELETEXT guides television viewers through details of home loan plans.

YOU'VE SEEN THE REST... NOW LOOK AT THE BEST!



EZ 6200
\$105

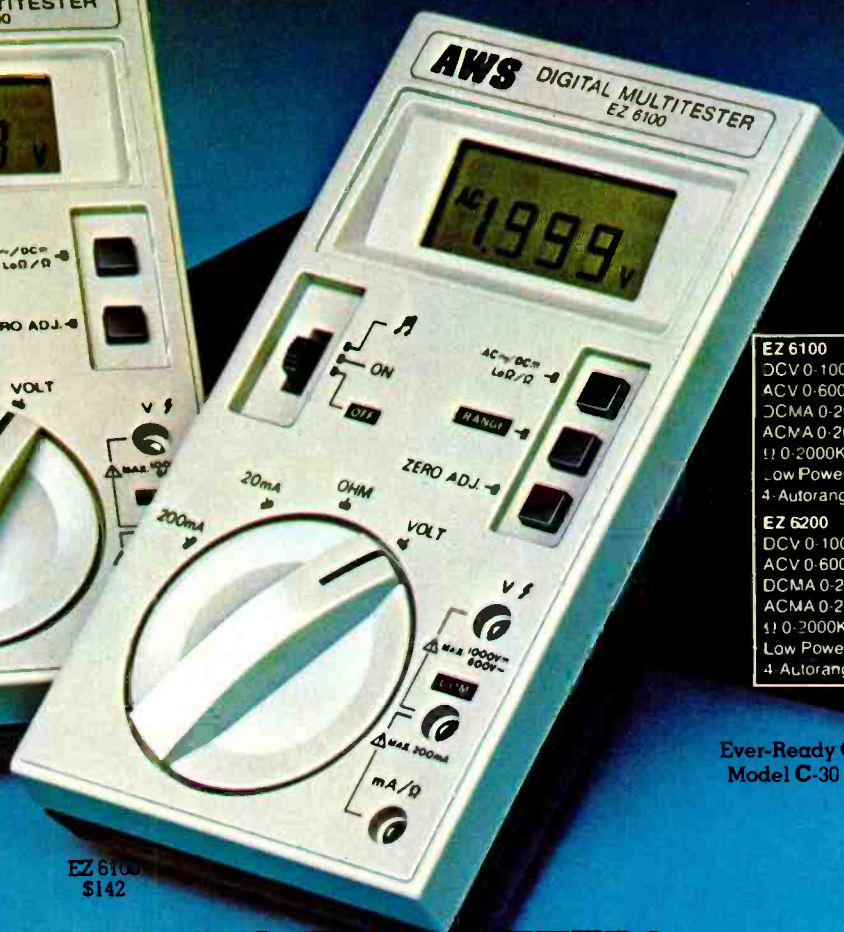

EZ 6100
\$142

EZ 6100	
DCV 0-1000	5-Autoranges
ACV 0-600	4-Autoranges
DCMA 0-200	2-Ranges
ACMA 0-200	2-Ranges
!! 0-2000K!!	5-Autoranges
Low Power !!	0-2000K!!
4-Autoranges Plus Continuity Buzzer	
EZ 6200	
DCV 0-1000	5-Autoranges
ACV 0-600	4-Autoranges
DCMA 0-200	1-Range
ACMA 0-200	1-Range
!! 0-2000K!!	5-Autoranges
Low Power !!	0-2000K!!
4-Autoranges	

Ever-Ready Case
Model C-30 \$20

PRESENTING EASTMETER™ UNPRECEDENTED FIVE-YEAR WARRANTY.

- Autoranging on Volts and Ohms
- Easy reading 3½ digit display
- CMOS-LSI advanced circuitry
- Autopolarity
- Automatic indication, unit and signs
- Easy to operate
- Economically powered with two "AA" 1.5V batteries
- Low battery drain, 300 hours continuous operation
- Low battery warning sign
- Lo Power and Normal Ohm ranges
- Range hold
- Buzzer continuity check

- Zero adjust feather-touch button
- AC/DC Lo Ω/Ω function selection by feather-touch button
- Safety fused
- Pocket-size, compact, lightweight, nicely balanced
- Shock resistant ABS housing
- Reliable, accurate, and rugged

For ordering information contact A. W. Sperry Instruments Inc., 245 Marcus Blvd., Hauppauge, N.Y. 11787, 800-645-5398 Toll-Free (N.Y., Hawaii, Alaska call collect 516-231-7050).

A.W. SPERRY INSTRUMENTS INC.
The Measurable Advantage.

CIRCLE 44 ON FREE INFORMATION CARD

www.americanradiohistory.com

See us at
WESCON '81
Booth H23

This man is looking for **AN ELECTRONIC BREAKTHROUGH.**

Join him in the incredible world of
electronics with NRI's all-new training
in the career of the future...
Electronic Design Technology.

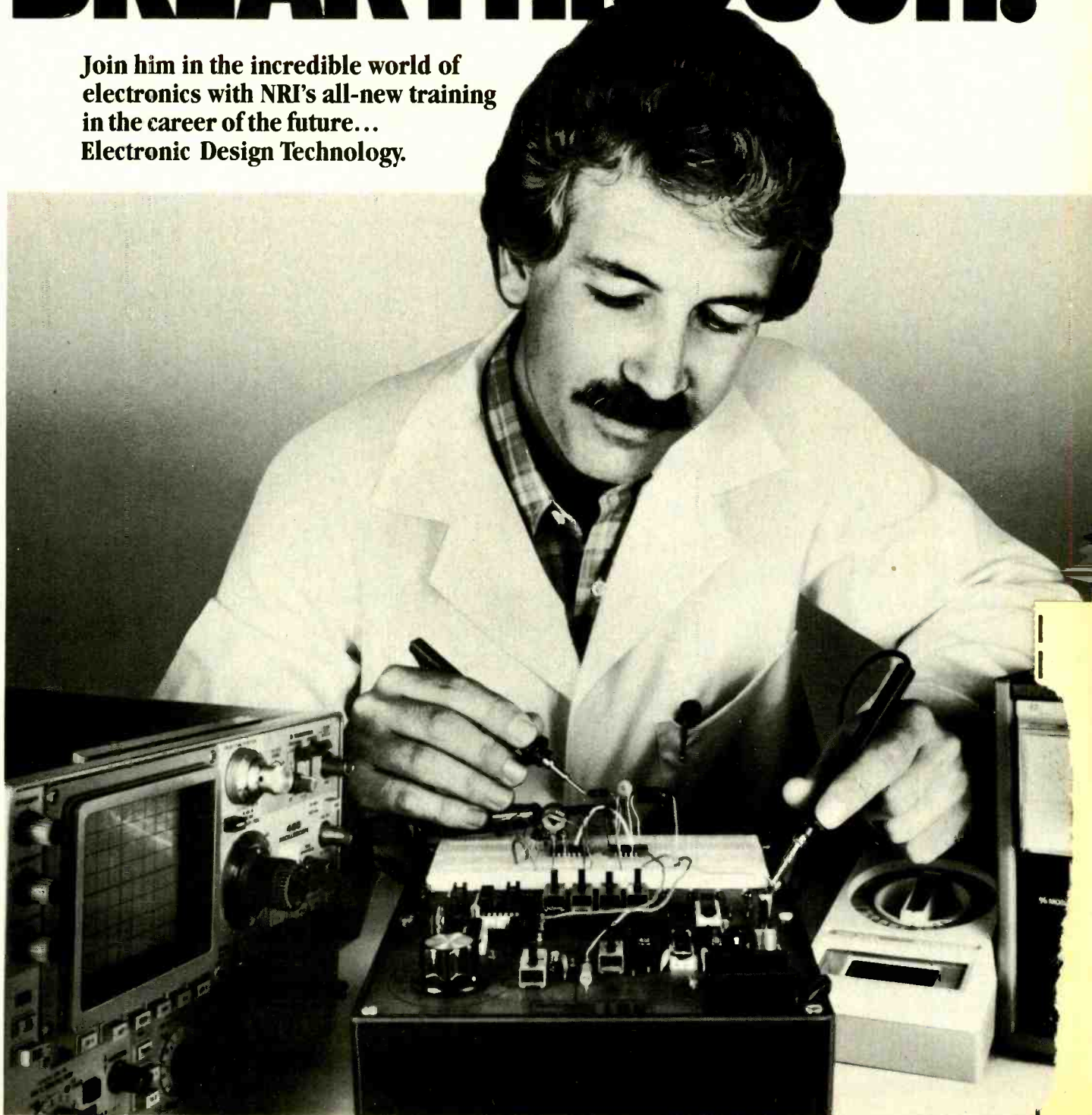

It's an electronic world we live in. And the designers of electronic circuits, controls, and systems are the people who are shaping it. Take your place in this exclusive company with this exciting new training from NRI.

You can learn Electronic Design Technology at home, in your spare time. Without quitting your job, tying up your evenings at night school, or wasting gas traveling to classes. Because NRI comes to you, makes you a class of one with a complete, effective, low-cost learning program designed exclusively for home study. You get it all... at your convenience.

Hands-On Training

NRI trains you for action. You get real-life experience that builds priceless confidence, gives you working knowledge of lab practices and techniques. It's all built into the NRI Design Lab,[®] a complete combination of equipment, hardware, training, and reference materials. You'll design your own circuits from the very beginning, progressing from basic passive networks through key circuits like power supplies, amplifiers, oscillators, digital and logic circuits, phase-locked loops and more. You'll move on to linear and digital integrated circuits, the heart of modern electronic equipment. You'll prototype your designs and verify operation, learning professional test and measurement procedures as you progress.



Professional Equipment Included

All the way, you work with professional-quality instruments like the Beckman 6-function, 26-range LCD digital multimeter. It gives you fast, accurate measurements of voltages, currents, and resistances, even forward voltage



Training includes NRI Design Lab, Beckman digital multimeter, Texas Instruments scientific calculator that you use and keep.

drops across in-circuit diodes and transistors.

You'll breadboard your designs on the unique NRI Circuit Designer. It features built-in multiple power supplies, variable signal generator, logic switches and LED indicators. It handles almost any circuit you can design... linear and digital integrated circuits as well as discrete components such as transistors and diodes.

Analysis and design work is speeded with the Texas Instruments TI-30 scientific calculator. This engineer's instrument includes full trigonometric functions, logarithms, square root, squares, powers, memory, and more. All this fine equipment is part of your training, yours to keep and use in your work.

NRI Fast-Track Training

This is the unique NRI lesson concept that simplifies and speeds learning. From the very basics to advanced, state-of-the-art electronics, each lesson is especially prepared for individualized instruction. Each subject is covered fully and thoroughly, but extraneous material is eliminated, language is clear and to the point, organization is logical and effective. From Fundamentals of Electronic Circuits through Microprocessors, your lessons are designed with you in mind.

No Experience Necessary

You don't have to be an engineer (or even a college student) to succeed. High school graduates with some algebra handle it without any trouble. We start you at the beginning, let you advance just as quickly as you're ready. We even include the NRI Math Refresher Module to help you brush up on your math and teach you any new concepts you may need.

Free Catalog, No Salesman Will Call

Our free, 100-page catalog gives you all the details, including lesson outlines, equipment specifications, and career opportunities. Send for it today and find the breakthrough for your future. If card has been removed, please write to us.



NRI SCHOOLS
McGraw-Hill Continuing
Education Center
3939 Wisconsin Ave.
Washington, DC 20016

We'll give you tomorrow.

WHAT'S NEWS

continued from page 6

vice-shop owner the prestige that small business proprietors in other fields have achieved through national franchise organizations. (See the March 1981 ("What's News") and April 1981 issues of **Radio-Electronics**.)

The areas now under development include a population of roughly nine million persons. They are Dallas, Minneapolis/St. Paul, sections of Chicago, Cleveland, Cincinnati, Louisville, Tampa/St. Petersburg, Orlando, Sarasota, and Daytona Beach. Those areas could support approximately 100 service centers, Mr. Lay believes.

Newest car stereo has liquid cooling system

"An auto stereo system that's so hot it has to be water cooled," says Toyota of its new stereo radio for compact cars. The company further claims that the new radio's sound is "just short of a live rock concert or symphony orchestra."

The new system is standard on 1981 Cressida models and optional on Coronas. It is the industry's first use of a "heat-pump" cooling system, similar to an engine's radiator. Fluid moves through tubes surrounding the radio and four separate amplifiers. Each amplifier drives one of four speaker channels, at a rate of 10 watts per channel.

"The heat pump was found only on the finest home stereo sets until this automotive unit was developed," reports a Toyota spokesman. "The added cooling allows increased power and

vastly improved sound on a chassis small enough to fit in a subcompact car."

Along with the heat-pump cooling system, the radio has several other features normally found only on home receivers. A quartz synthesizer locks directly onto broadcast frequency channels. Tuner transistors adjust for constantly changing automotive reception conditions. Other circuits suppress radio interference noise. Touch-tuning also is used.

1,125-line video system is developed by Sony

A new high-standard video recording and playback system was demonstrated recently in Tokyo by Sony Corp. Its 1,125-line, 60-field system, with a bandwidth of about 30 MHz, can handle more than five times as much information as the present standard NTSC system, with its 525 lines and bandwidth of 4.2 MHz.

The high-definition video system (HDVS) has three channels, processing the red, blue, and green signals separately from camera input to video output. The bandwidth is about 30 MHz for each of the three color channels.

The 1,125-line system consists of a high-definition 3-tube TV camera, using the new 1-inch Saticon pickup tube developed and patented by the Japan Broadcasting Corp (NHK); a 1-inch wideband RGB videotape recorder, using a new high-density recording format, and a wide-

band digital time-base corrector, using a new wideband analog-to-digital converter.

The high-definition system, which produces quality at least equal to that of 35-mm movie film, is expected to change the production and distribution of motion pictures dramatically in the near future, much as high-quality sound tape changed the technology of phonograph disc recording. It has the same advantages of repetitive recording and playback for on-the-spot preview and trial editing. That will reduce production time, film consumption, developing, and other costs greatly.

Not only is a revolution in film production expected, but the system has applications in film distribution, satellite broadcasting, cable TV, and optical fiber transmission.

Utah approves police radar—also "fuzz detectors"

In their Spring 1981 session, Utah legislators defeated both a bill seeking to curtail the use of police radar on the highways, and one to prohibit Utah motorists from equipping their cars with radar detectors. Thus in the same session of the Legislature they gave tacit approval to highway radar and to attempts to neutralize it.

The bill to prohibit radar detectors was defeated 45 to 21, on the basis of probable unconstitutionality. The Communications Act of 1934 prohibits states from legislating in the area of radio reception, and thus covers radar detectors, which are receivers. Difficulty of enforcement was another factor that contributed to the defeat of the radar-detector bill.

The bill intended to curtail the use of police highway radar was defeated in the Utah Senate, with a vote of 18 to 9.

Visual-display terminals pose no radiation problem

Visual-display terminals (VDT's) are safe, the president of the Computer and Business Equipment Manufacturers Asso-

ciation told a Congressional committee.

The president, Vico E. Henriques, pointed out to the subcommittee on Investigation and Oversight of the House Committee on Science and Technology that a recent Food and Drug Administration report shows that radiation from VDT's is well within the existing international, federal, and state guidelines.

His industry, said Mr. Henriques, has been sensitive for years to the need of keeping RF radiation extremely low. Not only does human health and safety require it, but many of the association's products are used close to equipment which is also highly sensitive to RF. He mentioned communications equipment as an example, and also mentioned that some display terminals are used in militarily secure areas where RF radiation could reveal the presence of an installation to enemy forces or espionage agents. Designing safeguards against those problems, he said, resulted in RF radiation levels so low that no significant biological effects are anticipated.

Ray-O-Vac now making lithium batteries

Under the terms of an agreement with Matsushita Electric Industrial Co., Ray-O-Vac Corp is granted a non-exclusive license to make, use and sell lithium batteries produced under the Matsushita patents on carbon monofluoride lithium cells. The 10-year agreement also includes technical collaboration between the two companies.

Ray-O-Vac has also announced its introduction of three coin-size lithium-carbon-monofluoride batteries—BR2016, BR2320, and BR2325. They have a nominal voltage of 3.0 and an energy density five times (in some cases ten times) higher than conventional units of similar weight.

The high energy density of these batteries makes them an ideally suited power source for electronic watches, calculators, measuring instruments, and computer memory back-up power, as well.

R-E

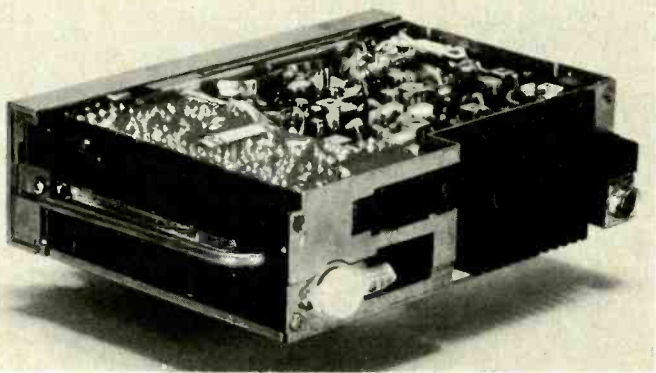

TOYOTA'S NEW LIQUID-COOLED CAR STEREO SYSTEM.

Into electronics, computers, or amateur radio? Choose 6 informative books for only \$ **2** 95

(values to \$121.65)

8434 List \$31.90
2 vol. count as 1
30 PROJECTS TO IMPROVE YOUR STEREO SYSTEM BY DAVID B. WEEMS

955 List \$10.95
Modern Digital Communications

1066 List \$19.95
THE ILLUSTRATED DICTIONARY OF ELECTRONICS

1233 List \$14.95
AGC/DC ELECTRONICS

1251 List \$16.95
Playing The Stock & Bond Markets With Your Personal Computer by L. S. Schmetz

1211 List \$14.95
THE COMPLETE HANDBOOK OF VIDEOTAPE RECORDERS 2ND EDITION

1216 List \$12.95
Towers: International Op Amp Linear IC Selector

714 List \$8.95
Radio Astronomy for the Amateur by Dave Heiserman

1108 List \$11.95
LASERS THE LIGHT FANTASY

1218 List \$16.95
HOW TO TROUBLESHOOT & REPAIR ELECTRONIC CIRCUITS

1076 List \$12.95
Artificial Intelligence Making machines "think"

1339 List \$13.95
101 EASY TEST INSTRUMENT PROJECTS

1222 List \$12.95
EASY-TO-BUILD ELECTRONIC PROJECTS

1278 List \$16.95
MODERN COMMUNICATIONS SWITCHING SYSTEMS 2ND EDITION

1337 List \$9.95
49 EASY-TO-BUILD ELECTRONIC PROJECTS

1265 List \$18.95
A BEGINNER'S GUIDE TO COMPUTERS & MICROPROCESSORS with projects

1230 List \$15.95
THE COMPLETE HANDBOOK OF AMPLIFIERS, OSCILLATORS & MULTIVIBRATORS

1276 List \$15.95
Computer Graphics with 29 ready-to-run programs

1233 List \$9.95
BUILD-IT BOOKS OF DIGITAL ELECTRONIC TIMINGS

1265 List \$18.95
GIANT HANDBOOK OF 222 WOUND ELECTRONICS PROJECTS

1132 List \$10.95
HANDBOOK OF ELECTRICAL NOISE: MEASUREMENT & TECHNOLOGY

1249 List \$15.95
103 PROJECTS FOR ELECTRONICS EXPERIMENTERS

841 List \$9.95
BUILD YOUR OWN WORKING ROBOT

1245 List \$16.95
ELECTRICAL WIRING HANDBOOK

1062 List \$12.95
THE A TO Z BOOK OF COMPUTER GAMES

1120 List \$8.95
OSCAR: The Ham Radio Satellites

7 very good reasons to try Electronics Book Club...

- **Reduced Member Prices.** Save up to 75% on books sure to increase your know-how
- **Satisfaction Guaranteed.** All books returnable within 10 days without obligation
- **Club News Bulletins.** All about current selections—mains, alternates, extras—plus bonus offers. Comes 14 times a year with dozens of up-to-the-minute titles you can pick from
- **"Automatic Order"**. Do nothing, and the Main selection will be shipped to you automatically! But... if you want an Alternate selection—or no books at all—we'll follow the instructions you give on the reply form provided with every News Bulletin
- **Continuing Benefits.** Get a Dividend Certificate with every book purchased after fulfilling Membership obligation, and qualify for discounts on many other volumes
- **Bonus Specials.** Take advantage of sales, events, and added-value promotions
- **Exceptional Quality.** All books are first-rate publisher's editions, filled with useful, up-to-the-minute info



ELECTRONICS BOOK CLUB
Blue Ridge Summit, PA 17214

Please accept my Membership in Electronics Book Club and send the 6 volumes circled below. I understand the cost of the books selected is \$2.95 (plus shipping/handling). If not satisfied, I may return the books within ten days without obligation and have my Membership cancelled. I agree to purchase 4 or more books at reduced Club prices during the next 12 months, and may resign any time thereafter.

714 733 841 905 955 1015 1062 1066 1076
1108 1120 1132 1211 1216 1218 1222 1230 1233
1245 1249 1251 1265 1276 1278 1337 1339 8434

Name _____ Phone _____

Address _____

City _____

State _____ Zip _____

(Valid for new members only. Foreign and Canada add 20%.)

RE-981

CIRCLE 14 ON FREE INFORMATION CARD

EDITORIAL

How Do You Stay Number 1?

The most important part of staying on top of the electronics industry is to be the first to know about new events that will shape the future of electronics. That's an easy rule to make, but it's not nearly as easy to make it work. It is, however, the kind of rule that we live by and it has made it possible for **Radio-Electronics** to bring its readers the first TV Typewriter in September, 1973; the first Build Your Own Computer in July, 1974; the first Build Your Own Satellite TV Receiver in February, 1980; and the first Build Your Own Robot in August, 1980.

What's next? That's our secret. To find out you must read every issue of **Radio-Electronics** or you're going to have to travel along with us, in person, as we tour the world in search of the latest developments in the electronics industry.

For example, in October we are taking a trip that will encompass the Japan Electronics Show in Osaka; the Korea Electronics Show in Seoul; the Taiwan Electronics Show in Taipei; and the Hong Kong Consumer Electronics Show. We've already been to both Consumer Electronics Shows in the United States (they were held in Las Vegas in January and Chicago in June). We've also attended the Electronic Distribution Show in Atlanta; Electro-81 in New York; numerous computer shows and Hamfests in various locations throughout the country and we will be showing up at Wescon in San Francisco this month.

These are the places we go to see what will be next in electronics. These are the places where we get the input we need to decide what kinds of articles we are going to bring you next year. These are the places we meet the authors who are going to present those articles. These are the places we go to stay on the top of the heap.

What's next in electronics? More than we both can imagine! There's digital audio on a miniature disc scanned by a solid-state laser, Teletext/Television, flat-screen TV (shirt-pocket size), wrist computers, two-way TV, 3D TV, an entire TV set on a single IC, direct satellite-to-home TV reception and who knows what else.

But when that story breaks, we will be there. We will learn everything there is to find out and bring it to you as quickly and as accurately as possible. That's our job and we believe we do it best. We made **Radio-Electronics** must reading. We intend to continue doing just that!



ART KLEIMAN
Managing Editor

Radio- Electronics®

Hugo Gernsback (1884-1967) founder
M. Harvey Gernsback, editor-in-chief
Larry Steckler, CET, publisher
Arthur Kleiman, managing editor
Josef Bernard, K2HUF, technical editor
Carl Laron, WB2SLR, assistant editor
Jack Darr, CET, service editor
Leonard Feldman
contributing high-fidelity editor
Karl Savon, semiconductor editor
Herb Friedman, communications editor
Gary H. Arlen, contributing editor
David Lachenbruch, contributing editor
Earl "Doc" Savage, K4SDS, hobby editor
Ruby Yee, production manager
Robert A. W. Lowndes, production
associate
Joan Burwick, production assistant
Gabriele Margules, circulation director
Arline R. Fishman,
advertising coordinator

Cover photo by Robert Lewis

Radio-Electronics is indexed in *Applied Science & Technology Index* and *Readers Guide to Periodical Literature*.

Gernsback Publications, Inc.
200 Park Ave. S., New York, NY 10003
President: M. Harvey Gernsback
Vice President: Larry Steckler
Secretary/Treasurer: Carol A. Gernsback

ADVERTISING SALES 212-777-6400

Larry Steckler
Publisher

EAST

Stanley Levitan
Radio-Electronics
200 Park Ave. South
New York, NY 10003
212-777-6400

MIDWEST/Texas/Arkansas/Okla.

Ralph Bergen
The Ralph Bergen Co.
540 Frontage Road—Suite 361-A
Northfield, Illinois 60093
312-446-1444

PACIFIC COAST Mountain States

Marvin Green
Radio-Electronics
413 So. La Brea Ave.
Los Angeles, Ca 90036
213-938-0166-7

SOUTHEAST

Paul McGinnis
Paul McGinnis Company
60 East 42nd Street
New York, N.Y. 10017
212-490-1021



Ω WEST COAST / EAST COAST Ω

Special
of the Month!

EPSON MX-80

INTERFACES: IEEE \$55, TRS-80 \$35,
APPLE INTERFACE & CABLE \$90,
RS-232 \$70

EPSON MX-80FT \$599
MX-100FT \$769



No Surcharge for Credit Cards Orders • We Accept C.O.D.'s
All Equipment Factory Fresh With MFT. Warranty • Stock Shipments Same Day or Next

NEC
OKIDATA
APPLE

TELEVIDEO
COMMODORE

RADIO SHACK
AMDEK

ATARI

DIABLO 630	\$2099
INTERTEC SUPERBRAIN 64K RAM	\$2799
QD SUPERBRAIN	\$3195
NEC 5510 SPINWRITER	\$2495
NEC 5530 SPINWRITER	\$2495
OKIDATA MICROLINE-80	\$ 399
OKIDATA MICROLINE-82	\$ 529
OKIDATA MICROLINE-83	\$ 769
APPLE II PLUS 48K	\$1189
APPLE DISK w/3.3 DOS Controller	\$ 545
APPLE DISK w/o Controller	\$ 435
BASE II PRINTER	\$ 599
HAZELTINE 1420	\$ 799
NORTHSTAR HORIZON II 32K QD	\$2975
ANADEX DP-9500	\$1295
TELEVIDEO 912C	\$ 669
TELEVIDEO 920C	\$ 729
TELEVIDEO 950	\$ 959
CBM 8032 COMPUTER	\$1225
CBM 8050 DISK DRIVE	\$1449
CBM 4032 COMPUTER	\$1090
CBM 4040 DISK DRIVE	\$1090
CBM 4022	\$ 679
CBM VIC-20	\$ 289
CBM C2N	\$ 85
RADIO SHACK II 64K	\$3245
RADIO SHACK III 16K	\$ 839
LEEDEX/AMDEK 100	\$ 139
LEEDEX/AMDEK 100G	\$ 169
LEEDEX/AMDEK COLOR-1 13" Color Monitor	\$ 349
MICROTEK 16K RAMBOARD for Atari	\$99.95
MICROTEK 32K	\$ 165
ATARI 400 16K	\$ 349
ATARI 825 PRINTER	\$ 619
ATARI 850 INTERFACE	\$ 139
or both together	\$ 749
ATARI 810 DISK DRIVE	\$ 449
ATARI 800 32K	\$ 769
Call for price list of ATARI software	
NEC 12" MONITOR	\$ 229

PRICES ARE SUBJECT TO CHANGE WITHOUT NOTICE.

WEST COAST
1-800-235-3581



OMEGA SALES CO.
3533 Old Conejo Rd. #102
Newbury Park, CA 91320
1-805-499-3678
CA. TOLL FREE 1-800-322-1873



EAST COAST
1-800-556-7586

OMEGA SALES CO.
12 Meeting St.
Cumberland, RI 02864
1-401-722-1027



Ω **OMEGA SALES COMPANY**

CIRCLE 41 ON FREE INFORMATION CARD

LETTERS

WRONG ADDRESS

The address given for Design Specialty in the Lumitron-4 Light Sequencer article in the June 1981 issue of **Radio-Electronics** is wrong.

The correct address is: Design Specialty, 15802 Springdale St., Suite 80, Huntington Beach, CA 92649.
DAVID L. HOLMES

OOOOOOOPS!

I believe that there are several errors and inconsistencies in the article, "\$60 Modem" (**Radio-Electronics**, June 1981). It appears as if changes were made to the parts list and parts-placement diagram, but those changes were not carried through to the other diagrams.

The parts-placement diagram lists no less than three R39 resistors: one within the dotted-line box at the lower left (call that one A); one between pins six and seven of IC2 (call that one B), and the last

one hangs off pin one of IC2 (call that one C).

From the circuit diagram (Fig. 3), R39-C clearly should be R25; that's supported by the fact that R25 is entirely missing from the parts-placement diagram.

The other two R39's are both described in the parts list. Let us allow one (my R39-B) to remain R39 at 22K ohms. That leaves the last one, R39-A, which is described correctly as 10K. Let R39-A become R40, and I believe that our problems are solved.

To correct the other diagrams: in Fig. 2, the input from the answer filter should read "FROM-R40," and note that R25 is correct as output from the first stage of the originate filter. In Fig. 3, R39 in the upper left should be R40 (input to answer filter) and the R39 in the lower left is correct. R39 in Fig. 9 should also read R40.

Please continue to present us with the fine and useful articles that you have published in the past. An occasional typo-

graphical error will get by you—no one's perfect—but you have a lot of people out here willing to make final corrections. And sometimes, as with my own experience with this "modem" article, I find that I have benefitted more than had it been 100% correct.

MICHAEL D. HOFER,
Hicksville, NY

ANTI-RADAR WEAPON

The ever-increasing pollution of our highways with police radars, and the numerous local court decisions against American motorists who are ignorant of the workings of such devices, threaten to lead to the same state of lawlessness that our historical West became so famous for. As in old times, vigilantes have begun to organize, and have already found a famous scientist as their mentor: *Heinrich Hertz*. His celebrated, spark-excited wide-band microwave source is the ideal ECM

continued on page 22

Price Without Sacrifice.



HITACHI V-302B & V-152B

Put a proven Hitachi dual-trace oscilloscope on your bench for as little as \$735. Our V-152B 15MHz model includes unprecedented sensitivity (1 mV/div.)...10X sweep magnification...front panel XY operation...trace rotation...Z-axis input...and more. Need greater bandwidth? Our V-302B model is the only 30MHz dual-trace scope with signal delay line priced under \$1000, with all the above features, to make your testing operations fast, easy, and accurate. Reliability is exceptional, too. (As you'd expect from a manufacturer with over 20 years of experience "outscoping" the competition.) So exceptional, in fact, that Hitachi quality is backed by a 2-year warranty...the longest in the industry. Whether you use it for teaching or repairs, for video, audio, or computer testing, you can't find more scope for your dollar than at Hitachi. Write for more details.

Hitachi...The measure of quality.

- V-152B 15 MHz Dual Trace . . . \$735*
- V-302B 30 MHz Dual Trace . . . \$995*

*Probes included.



HITACHI

Hitachi Denshi America, Ltd.
175 Crossways Park West
Woodbury, NY 11797
(516) 921-7200

CIRCLE 69 ON FREE INFORMATION CARD



- Full info LCD readout
- 0.1% DCV accuracy
- Full range hi-lo power ohms
- 1 amp. (AC & DC)
- 1000 VDC, 600 VAC
- Auto polarity/zero
- Raised guard-edge case
- Tilt stand

WD-759 3 1/2 DMM

Look at the extra quality VIZ gives you for \$159.95.

THINK OF PERFORMANCE.

With 0.1% DCV accuracy, VIZ 3 1/2 DMMs perform as well in the lab as in the field. Bright LCD readout—settling speed is less than 1 second. Full range hi-lo power ohms means extra accuracy in all your resistance measurements. Readout window shows: function (V, A, Ω); value; AC

or DC; minus or plus; and low battery. **THINK OF USE.**

Easy-to-use range and function switches help avoid errors. Jacks or standard 3/4" dual plug centers. Unit comes with tilt stand, deluxe probes and batteries. H.V. probe, AC adapter, LED continuity probe and carrying case, optional.

THINK OF PROTECTION.

Tough, impact-resistant case has raised guard-edge, protecting unit from damage if dropped on face. Built-in fuse and spare easily accessible from back.

WANT LED?

WD-758 available with LED readout for \$10 less.

VIZ bench DMMs

Laboratory quality for bench or portable use. Battery or AC power. Accuracy 0.1% DCV. 10 amp. AC or DC. Voltage ranges 0.1 mV to 1000V AC & DC. Fully shielded metal case. Long battery life. Deluxe test leads and AC adapter supplied. Optional accessories; H.V. probe.



Handy handheld WD-747

Premium quality 3 1/2 DMM at low prices. Side switches. 0.5" digits. Accuracy 0.8% DCV. **\$89.95**

VIZ reliability.

VIZ is a 50 year-old company. Our instruments are fully warranted, parts and labor, for a year. All items tested to NBS standards. We offer service and parts availability for a minimum of ten years. Over 15 repair depots in U.S.A.



WD-760. LED. Manual ranging. **\$215.95**

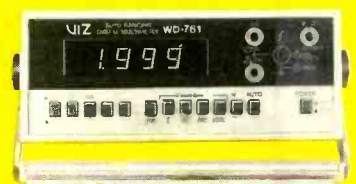

WD-761. LED. Autoranging. **\$275.40**



WD-762. LCD. Manual ranging. **\$219.95**

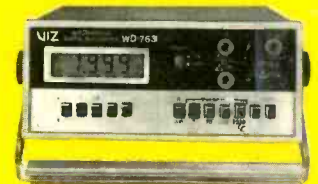

WD-763. LCD. Autoranging. **\$282.50**

Want full technical details and a demonstration? Call toll-free. 1-800-523-3696, for the VIZ distributor near you.

VIZ

Look to VIZ for value, quality, availability.
Over 70 instruments in the line.

VIZ Mfg. Co., 335 E. Price St., Philadelphia, PA 19144

CIRCLE 6 ON FREE INFORMATION CARD

www.americanradiohistory.com

Go with McGraw-Hill's EXPERIENCE!

McGraw-Hill's NATIONAL ELECTRICAL CODE® HANDBOOK, 17/e. By J. F. McPartland. 1,162 pp., 1,096 illus. Bigger and better than ever! This mammoth reference explains and clarifies the many complex provisions of the current (1981) Code® to help you meet rules exactly and pass inspections the very first time.

456/933 Pub. Pr., \$24.50 Club Pr., \$18.95

ELECTRONICS ENGINEERING FOR PROFESSIONAL ENGINEERS' EXAMINATIONS. By C. R. Hafer. 336 pp., more than 200 illus. Actually two books in one—a quick preparation manual to help you pass your P.E. exams on the first try and a rich source of practical electronics engineering information and know-how.

254/303 Pub. Pr., \$22.50 Club Pr., \$17.50

ELECTRONICS CIRCUITS NOTE BOOK: Proven Designs for Systems Applications. By S. Weber, Editor in Chief. 344 pp., illus. Containing 268 ready-to-use or adapt circuits—each a proven solution—this book brings you the best of the best articles published in *Electronics'* popular Designer's Casebook section. Covers display circuits, encoders and decoders, filters, function generators, logic and memory circuits, microprocessors, and more.

192/448 Pub. Pr., \$32.50 Club Pr., \$25.50

OPTICAL FIBRE COMMUNICATION. By Technical Staff of CSELT. 928 pp., 519 illus. Brings you a complete worldwide overview of one of today's most important technologies—from the basics to the highest technical levels currently possible. It's the first book to cover both the theoretical and technological aspects of optical fiber communication as well as practical design, production, measurement, installation, implementation, and operation.

148/821 Pub. Pr., \$39.50 Club Pr., \$29.50

DESIGNING WITH FIELD-EFFECT TRANSISTORS. By Siliconix, Inc.; edited by A.D. Evans. 304 pp., 269 illus. Here's the full story of FETs and FET applications. It presents the necessary theory and a large number of design examples for such applications as amplifiers, analog switches, voltage-controlled resistors, constant-current supplies, power switching, and ICs. Geared to help you use FETs to maximum advantage.

574/499 Pub. Pr., \$24.50 Club Pr., \$18.50

THE ARCHITECTURE OF PIPELINED COMPUTERS. By P. M. Kogge. 352 pp., 180 illus. This guide summarizes and explores the state of the art in pipelining and shows you how to solve practical design problems. Discussions range from logic design considerations through the construction, cascading, and control of pipelined structures to the development of programming techniques.

352/372 Pub. Pr., \$27.95 Club Pr., \$21.95

BUY ONE of these great professional books and **GET ONE FREE** when you join McGraw-Hill's Electronics and Control Engineers' Book Club (values up to \$69.50)

Choose any one of these books at the special Club discount, and select any other as your gift free-of-charge when you enroll!



HANDBOOK OF OPERATIONAL AMPLIFIER CIRCUIT DESIGN. By D. F. Stout; edited by M. Kaufman. 434 pp., 223 illus. Compact, concise, highly concentrated, and containing a storehouse of information, this one-stop volume will help you quickly solve any op amp circuit problem!

617/97X Pub. Pr., \$34.50 Club Pr., \$25.50

MODERN ELECTRONIC CIRCUITS REFERENCE MANUAL. By J. Markus. 1,264 pp., 3,666 circuit diagrams. This 103-chapter guide means you can speed up the production of new electronic devices with ease and thereby lower your production costs. Complete with values of components and suggestions for revisions, plus the original source of each circuit in case you want additional performance or construction details.

404/461 Pub. Pr., \$49.50 Club Pr., \$38.50

OPTOELECTRONICS/FIBER-OPTICS APPLICATIONS MANUAL. By Applications Engineering Staff of Hewlett-Packard Optoelectronics Division. 2nd Ed., 400 pp., 448 illus., outsized 8½ x 11 format. Nearly doubled in size in this second edition, this handy source has the data and know-how you need to design circuits, specify components, and solve problems in optoelectronics engineering. To save you time, it's organized by product types and special functions, and each chapter is self-contained.

286/06X Pub. Pr., \$27.50 Club Pr., \$21.50

ELECTRONICS DESIGNERS' HANDBOOK, 2/e. Edited by L. J. Giacomello. 2,344 pp., 1,686 illus. Now doubled in size and with 90% of its material new, this famous classic (first edition by Landee, Davis, Albrecht) has been thoroughly revised and updated to give you not only the *how* and the *why* of all your design work but also the *how much* of every design step you take!

231/494 Pub. Pr., \$69.50 Club Pr., \$51.50

ELECTRONIC FILTER DESIGN HANDBOOK. By A. B. Williams. 576 pp., 408 illus. The book is organized so that you can start from practically any set of requirements and follow a sequence of clearly outlined steps and design filters ranging from simple networks to very complex configurations. Each design technique is illustrated with step-by-step examples and is accompanied by a wealth of applicable schematics, graphs, and tables of normalized numerical values.

704/309 Pub. Pr., \$32.50 Club Pr., \$25.50

LETTERS

continued from page 16

tool against the shiny, over-expensive, tax-financed fetish of our much-underutilized police forces.

Today, Uncle Heinrich would take an old coffee can and cut it into two halves along its axis. He would mount into one of them, as a lambda-half dipole, two small nails (the more rusty, the better), and power that beam-forming contraption with an ignition coil from a junked car. Throw the switch and—victory! The ultimate anti-radar weapon in the battle on the roads is in full operation!

If Uncle Heinrich were to enter a state

that outlaws such devices, he would simply say that he was re-checking his discovery.

Radio-engineers, amateurs, tinkerers—where has your pioneering spirit been in all these years since the first highway radar toys appeared?

REINHOLD GERHARZ,
Fort Belvoir, VA

Z-80 TRAINERS

In the article, "Learning About Microprocessors," by Jorma Hyypia (*Radio-Electronics*, May 1981), the author states that there are no Z-80 trainers on the market. I think that is wrong.

SD Systems makes a very good microprocessor trainer and development system, called the Z-80 Starter System. It

contains a hexadecimal keyboard; Z-80 microprocessor; Z-80 parallel interface; Z-80 counter-timer circuit; tape interface; two S-100 sockets; wire-wrap area, and an EPROM programmer.

Please let your readers know that they can have the best microprocessor on the market in a trainer that not only trains but lets them do it with style.

ROBERT SMITH,
Michigan City, IN

UNICORN-1 ROBOT

Here's a picture of the Unicorn-Robot 1 that I am building. It's a close-up of the manipulator I designed and built. The "fingers" of this end effector are parallel, and open or close by moving toward or away from each other. This type of end



effector gives my robot a better grip than those originally described.

I think your magazine is fantastic, and I look forward to it every month.

MALCOLM P. STOCKINGER,
Ypsilanti, MI

If you're building the Unicorn-One robot (or any other) I have a suggestion about assembling the upper arm.

On the first crossbar rod, where the threaded rod fits, don't drill the hole all the way through. Instead, drill it to a depth of about $\frac{5}{16}$ inch. File the end of the threaded rod smooth and, before inserting it, drop a small steel ball in the hole. Be sure to leave a $\frac{1}{32}$ -inch or so space between the gear and the crossbar rod. Then, when the assembly is pulled down by the weight of that lower arm, the rod will spin much more easily, and will take considerable strain off the motor, as the steel ball will act as a bearing.

That's a lot less trouble than trying to fit a regular ball bearing on the crossbars and much better than a plain hole.

A.M. FALCETANO,
APO NY 09026

NEW COMPUTER CLUB

My name is Scott Summer. This letter is to inform your readers of a new computer club that I am forming in Rhode Island. Our club publication will be titled *The National Apple Newsletter* and it will be for owners and users of *Apple II* or *Apple II Plus* computer systems.

The newsletter will print anything that
continued on page 26

Give Your Working Hand The Help It Deserves

... help from tools that feel right, work right, save time. Tools that stay on the job year after year. Tools precision made of drop forged, fine polished, high grade steel. That give you quality in every detail (at no premium in price). Tools by CHANNELLOCK. Be sure THAT trade name is on the tools you buy.

CHAN NEL LOCK

CHANNELLOCK, INC. • Meadville, Pennsylvania 16335
Meet The Rest Of The Family. Send For Our Free Catalog.

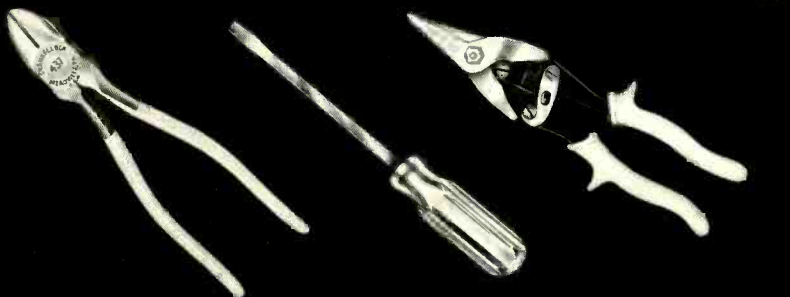

BIT-SLICE MICROPROCESSOR DESIGN. By J. Mick and J. Brick. 320 pp., 230 illus. All in one place—the crucial information you've been needing about the 2900 family of bit-slice microprocessor components! A remarkable "first," this book designs right before your eyes not just one but two complete 16-bit machines!
417/814 Pub. Pr., \$24.00 Club Pr., \$14.50

DIGITAL HARDWARE DESIGN By J. B. Peatman. 428 pp., over 400 illus. Taking you beyond the microcomputer, this guide re-examines traditional techniques and focuses maintainability as a key goal, on the design of circuitry too fast for the microcomputer alone, and on designing for usefulness. It covers everything from algorithmic state machines to separately clocked circuits—with scores of examples.
491/321 Pub. Pr., \$31.95 Club Pr., \$24.95

HANDBOOK OF ELECTRONICS CALCULATIONS FOR ENGINEERS AND TECHNICIANS. Edited by M. Kaufman and A. H. Seidman. 653 pp., 725 illus. This first comprehensive tool of its kind includes hundreds of worked-out problems in analog and digital circuits. Includes more than 700 diagrams, curves, tables, and graphs.
333/920 Pub. Pr., \$27.50 Club Pr., \$21.00

INTRODUCTION TO THE THEORY AND DESIGN OF ACTIVE FILTERS. By L. P. Huelsman and P. E. Allen. 430 pp., illus. Once you add active filter design to your repertoire of specialties, you'll possess a skill that's in great demand today. Here's one of the best texts we know on the theory, design, application, and evaluation of modern active filters and the various techniques used today.
308/543 Pub. Pr., \$28.50 Club Pr., \$21.50

USER'S GUIDEBOOK OF DIGITAL CMOS INTEGRATED CIRCUITS. By E. R. Hnatek. 339 pp., 245 illus. Providing the first comprehensive overview, this practical guide covers CMOS logic performance characteristics and selected circuit applications, data conversion and telecommunication circuits, CMOS memories, and commercially available CMOS microprocessors.
290/679 Pub. Pr., \$24.50 Club Pr., \$18.50

INTRODUCTION TO RADAR SYSTEMS, 2/e. By M. I. Skolnik. 698 pp., 244 illus. This new edition of a widely used text on radar from the systems engineer's point of view brings you full discussions of the many major changes that have occurred in the field recently.
579/091 Pub. Pr., \$38.50 Club Pr., \$30.50

ELECTRONIC COMMUNICATION, 4/e. By R. L. Shrader. 801 pp., 870 illus. This thoroughly updated edition offers all the theory and fundamentals you need to prepare yourself for the FCC commercial and amateur grade license examinations—and pass them the first time!
571/503 Pub. Pr., \$21.95 Club Pr., \$16.95

PRINTED CIRCUITS HANDBOOK, 2/e. By C. F. Coombs, Jr. 256 pp., 327 illus. Blueprints every important phase of printed circuitry. Provides the information you need to establish a production facility and control the processes. A virtual encyclopedia in the field, five major sections cover engineering, fabrication, assembly, soldering, and testing.
126/089 Pub. Pr., \$38.50 Club Pr., \$28.95

STANDARD HANDBOOK FOR ELECTRICAL ENGINEERS, 11/e. By D. G. Fink and H. Beaty. 2,448 pp., 1,414 illus. Today's most widely used source of electrical engineering information and data serves you as no other single work when you need detailed, timely, and reliable facts and how-to on the generation, transmission, distribution, control, conversion, and application of electric power.
209/74X Pub. Pr., \$59.95 Club Pr., \$44.95

Be sure to consider these important titles as well!

DIGITAL FILTERS. By A. Antoniou. 021/171 Pub. Pr., \$32.95 Club Pr., \$24.95

ELECTRONIC DISPLAYS. By E. G. Bylander. 095/108 Pub. Pr., \$24.50 Club Pr., \$18.50

MICROCOMPUTER-BASED DESIGN. By J. Peatman. 491/380 Pub. Pr., \$32.50 Club Pr., \$25.50

MICROPROCESSORS/MICROCOMPUTERS/SYSTEM DESIGN. By Texas Instruments Learning Center & Engineering Staff. 637/58X Pub. Pr., \$24.50 Club Pr., \$19.50

ENGINEERING MATHEMATICS HANDBOOK, 2/e. By J. J. Tuma. 654/298 Pub. Pr., \$28.50 Club Pr., \$21.95

RADIO HANDBOOK, 21/e. By W. Orr. 772/630 Pub. Pr., \$21.50 Club Pr., \$16.60

TRANSFORMER AND INDUCTOR DESIGN HANDBOOK. By W. T. McLyman. 786/755 Pub. Pr., \$35.00 Club Pr., \$26.50

CRYSTAL OSCILLATOR DESIGN AND TEMPERATURE COMPENSATION. By M. E. Frerking. 784/973 Pub. Pr., \$18.95 Club Pr., \$14.95

MICROELECTRONICS. By J. Millman. 423/27X Pub. Pr., \$31.95 Club Pr., \$24.50

ELECTRONICS DICTIONARY, 4/e. By J. Markus. 404/313 Pub. Pr., \$29.95 Club Pr., \$22.50

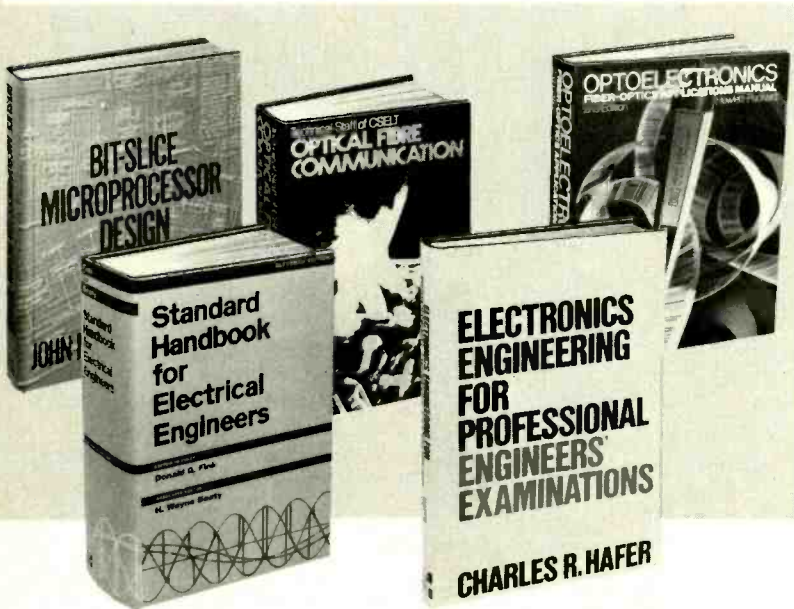

MAIL THIS COUPON TODAY

McGraw-Hill Book Clubs
Electronics and Control Engineers' Book Club
 P.O. Box 582, Hightstown, New Jersey 08520

Please enroll me as a member and send me the two books indicated, billing me for my first selection only at the discounted member's price, plus local tax, postage and handling. If not satisfied, I may return the books within 10 days and my membership will be canceled. I agree to purchase a minimum of 3 additional books during the next 2 years as outlined under the club plan described in this ad. Membership in the club is cancellable by me anytime after the four book purchase requirement has been fulfilled.

Write Code # of
FREE selection here

Write Code # of
FIRST selection here

Orders from outside the U.S. must be prepaid with international money orders in U.S. dollars.

Signature _____

Name _____

Address/Apt. # _____

City _____

State _____ Zip _____

This order subject to acceptance by McGraw-Hill. All prices subject to change without notice. Offer good only to new members. A postage and handling charge is added to all shipments. **E33480**

Why YOU should join now!

- **BEST BOOKS IN YOUR FIELD**—Books are selected from a wide range of publishers by expert editors and consultants to give you continuing access to the latest books in your field.
- **BIG SAVINGS**—Build your library and save money too! We guarantee savings of at least 15% off publishers' list prices on every book. Usually 20%, 25%, or even higher!

BONUS BOOKS—You will immediately begin to participate in our Bonus Book Plan that allows you savings between 70-80% off the publisher's price of many books.

- **CONVENIENCE**—14 times a year you receive the Club Bulletin FREE, fully describing the Main Selection and alternate selections, together with a dated reply card. If you want the Main Selection, you simply do nothing—it will be shipped automatically. If you want an alternate selection—or no book at all—you simply indicate it on the regular reply card and return it by the date specified. You will have at least 10 days to decide. If, because of late mail delivery of the Bulletin you should receive a book you do not want, just return it at the Club's expense.

As a Club member, you agree only to the purchase of four books (including your first selection) over a two-year period.

ALBIA Electronics

YOUR MAIL-ORDER ELECTRONIC SUPPLY HOUSE!

8 CHANNEL SCOPE MULTIPLEXER, DM-12

Convert your single channel scope into a 4 or 8 channel instrument; just connect the DM-12, 8 channel scope multiplexer to your scope, clip the 8 input probes to the signals you want to view. Simple, easy, fast — can handle logic level TTL signals from DC to 3MHz. Features separate spacing and trace amplitude controls and selectable sampling rate — all to insure easy clear scope display.

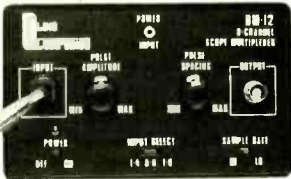

Completely assembled and tested! Ready to use!

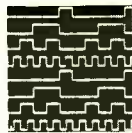

VIEW 8 CHANNELS AT ONCE!

\$69⁹⁵

- 8 TTL compatible input channels (1 TTL load per channel) can drive 50 Ohm scope cable
- Maximum full screen amplitude 1.6 volts adjustable
- Trace amplitude and spacing controls
- 4 or 8 channel selector switch
- 8 color coded input cable, 24" long with insulated alligator clips
- External 9 VDC power supply included (Model MMAC-2)
- Size 6.25" x 3.75" x 2"
- BNC Output Cable Accessory (Model PSA-2 add \$14.95)

LOW COST CAPACITANCE METER MODULE, DM-8

Connect this high quality low-cost Capacitance Meter Module, DM-8 to your digital Volt Meter and turn it into a Digital Capacitance Meter — the Low Cost Way!



Completely assembled and tested! Ready to use!

\$69⁹⁵

- Push to read range (button) from 1pF to 20,000µF
- Zero calibration control
- In one easy to use, self-contained package
- Battery powered, with "push to read" battery saver circuit (9V batteries not included)
- Size 6.25" x 3.75" x 2"

REGULATED TRIPLE POWER SUPPLY, LOW PRICED!, DM-6

A fully assembled and tested power supply that provides a solid, fully wired triple power supply including fixed 5V @ 1 Amp, 5V to 15V @ 0.5 Amp, and -5V to -15V @ 0.5 Amp — all supplies regulated, short proof. Each supply has short indicator LED. Complete and ready for use in a durable (8" x 6" x 1 1/2") metal case.

\$99⁹⁵



FREE!!
NEW 1981 FALL CATALOG
Exciting new products!
Send today!!



ALBIA SATISFACTION WARRANTY:

FOR FAST AND DEPENDABLE DELIVERY SERVICE

IN CT, AK & HI CALL COLLECT (203) 467-5590 **CALL TOLL FREE: 1-800-243-6953**

WE ACCEPT MASTER CHARGE, VISA AND AMEX CREDIT CARDS
Connecticut Residents add 7 1/2% Sales Tax • Prices shown in U.S. currency only. Foreign orders add 15%.

ALBIA ELECTRONICS INC

44 KENDALL ST. • P.O. BOX 1833 • NEW HAVEN, CT. 06508

HITACHI DC-15MHZ SINGLE-TRACE PORTABLE OSCILLOSCOPE AT THIS LOW, LOW PRICE

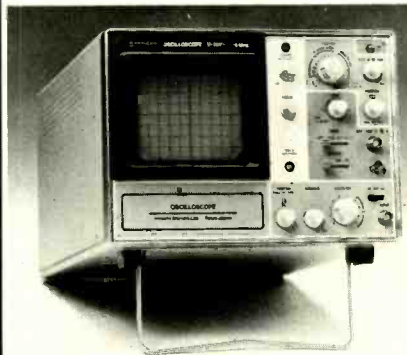

- CRT Display area 130BUB31 (5-inch, round shape) 8x10div (1 div = 9.5mm) Acceleration potential Approx. 2kV Intensity modulation Over 5Vp-p
- Vertical deflection Sensitivity and bandwidth 5mV/div—5V/div ± 5%, DC—15MHz, — 3dB 1mV/div—1V/div ± 6%, DC—5MHz Typ., — 3dB (Using x5 amplifier) 24ns Rise time Dynamic range More than 4div at 15MHz Input R and C Direct 1M Ohm, approx. 30pF Maximum input voltage 600Vp-p or 300V (DC + AC peak) Display mode Single-trace DC—500 kHz, 200mV/div X-Y operation Phase difference DC—10kHz 3°

- Horizontal deflection Sweep mode Auto, NORM, TV (+), TV (-) TV sync-separator circuit TV synchronization Over 1 div (V sync-signal) Internal Over 1 Vp-p (V sync-signal) External Over 1 Vp-p (V sync-signal)

Frequency	Internal	External
20Hz—2MHz	0.5div	200mV
2—15MHz	1.5div	800mV

- Trigger sensitivity =
- Sweep time 0.2µs/div—0.2s/div ± 5%, 19 calibrated steps
- Sweep-time magnifier 10 times (± 7%)
- Max. sweep rate 100ns/div

- Amplitude calibrator 1kHz ± 10% Typ, Square wave Waveform 0.5V ± 3% Voltage

- Power requirements 100V (120/220/240V) ± 10% 50/60Hz, 40W
- Dimensions Approx. 275(W) x 190(H) x 400(D)mm
- Weight Approx. 8.5kg
- Ambient operation temperature 0—+40°C

MODEL V-151B
WITH 2 YEAR MFG. WARRANTY
ONLY \$499⁹⁵

WITH FREE DM-12 8 CHANNEL MULTIPLEXER
A COMBINED VALUE AT LIST OF \$639.95
YOU SAVE \$140.00

If for any reason, whatsoever, you are not completely satisfied with your purchase, return it within 30 days of purchase date for a full refund — it's as simple as that! Shipping & Handling charges not refundable.

LOW COST HIGH FREQUENCY COUNTER



MODEL NO. DM-7

The Albia Model DM-7, 8 Digit High Frequency Counter is easy to use, switch selectable time base input by a single BNC, nothing to build!

- 5 Hz to 550 MHz
- 8 big easy-to-read, .43" high intensity LED display
- Crystal (± 3 ppm @ 25°) controlled 0.1 or 1.0 sec. gate times
- Convenient benchtop size (7" x 10" x 3") durable attractive case

COMPLETELY ASSEMBLED PRE-CALIBRATED PRE-TESTED

\$149⁹⁵

LOW OHM METER MODULE, DM-10



Measures resistance from 10 milliOhms to 20 Ohms. Now you can measure resistance down to 10 milliOhms with this low cost, easy to use DVM module. Check coil resistance, transformers, relays, chokes, printed circuit board copper paths and ground cables. Special zero balance control nulls out input cable resistance to insure accurate readings. Your DVM has to be set to 2V range during operation.

- Resistance range 10 milliOhms to 20 Ohms
- Zero Calibration control
- Battery powered (push to read battery saver circuit). Requires 1.9 Volt Battery (not included)
- Size 6.25" x 3.75" x 2" (Input cables not included or available)

\$69⁹⁵

FREQUENCY METER MODULE "5Hz to 100MHz", DM-11

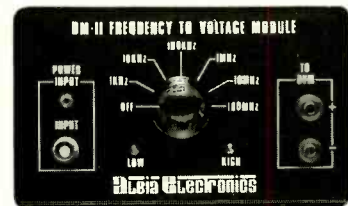

Measure frequencies from 5Hz to 100MHz on your digital voltmeter with a resolution of 3 1/2 digits — easy to use — perfect for field service — lab testing — home hobbyist! Connect the DM-11 to your DVM, set the DVM to the 2VDC range, connect a signal to the DM-11 via a BNC cable (not included) and measure the frequency of any source. Hi Lo Range LED's insure fast accurate readings.

- Frequency Range 5Hz to 100MHz
- Input Impedance 1 MegOhm
- Input Sensitivity: < 100Hz < 80mV > 100Hz — 60MHz < 30mV > 60MHz < 70mV

- Size 6.25" x 3.75" x 2"
- External 9V DC power supply included (Model MMAC-2)
- BNC Input Cable Accessory (Model PSA-2 add \$14.95)

\$69⁹⁵

POSTAGE & HANDLING	
ORDERS	ADD
UP TO \$10.00	\$1.95
\$10.01 - \$25.00	3.75
\$25.01 - \$50.00	4.65
\$50.01 - \$100.00	6.45
ORDERS OVER \$100.00 WITHIN UNITED STATES	7.55

FREE ALBIA DESIGNERS TEMPLATE WITH EVERY ORDER RECEIVED



SEPTEMBER » SPECIAL «

BK PRECISION

New Portable Digital
Capacitance Meter



MODEL 820
Call For Our Price

HITACHI

KEITHLEY



Non-Linear Systems

FLUKE

HICKOK

VIZ

TRIPLETT

PHILIPS

WESTON

Simpson

BK PRECISION

LEADER

DORIC

DATA PRECISION

**ADVANCE
ELECTRONICS**

THE TEST EQUIPMENT
SPECIALISTS



TOLL FREE HOT LINE
800-223-0474



54 WEST 45th STREET, NEW YORK, N.Y. 10036
IN NEW YORK STATE 212-687-2224

KEITHLEY

Model 169
BENCH/PORTABLE DMM
• 3½ Digit liquid crystal
display
• 0.25% basic accuracy
• 26 Ranges
\$189.00



80MHz Counter with Period Function



BK PRECISION

Call For Our Price

MODEL 1820

- 5Hz to 80MHz reading guaranteed—100MHz typical
- Period measurements from 5Hz to 1MHz.
- Period average, auto and manual positions
- One PPM resolution
- Totalizes to 999999 plus overflow
- Elapsed time measurements from .01 to 9999.99 seconds plus overflow
- One-megohm input resistance
- Bright .43" high LED readouts

New Low Distortion Function Generator

BK PRECISION



Call For Our Price

MODEL 3010

- Generates sine, square and triangle waveforms
- Variable amplitude and fixed TTL square-wave outputs
- 0.1 Hz to 1MHz in six ranges
- Push button range and function selection
- Typical sine wave distortion under 0.5% from 0.1Hz to 100kHz
- Variable DC offset for engineering applications
- VCO external input for sweep-frequency tests

New Sweep/Function Generator

BK PRECISION



Call For Our Price

MODEL 3020

- Four instruments in one package—sweep generator, function generator, pulse generator, tone-burst generator.
- Covers 0.02Hz-2MHz
- 1000:1 tuning range
- Low-distortion high-accuracy outputs
- Three-step attenuator plus vernier control
- Internal linear and log sweeps
- Tone-burst output is front-panel or externally programmable

- V-151B 15 MHz Single Trace
- V-152B 15 MHz Dual Trace
- V-202 20 MHz Dual Trace
- V-301 30 MHz Single Trace
- V-302B 30 MHz Dual Trace
- V-352 35 MHz Dual Trace
- V-550B 50 MHz Dual Trace, Dual Time Base
- V-1050 100 MHz Dual Trace, Dual Time Base

Call For
Special Intro
Price Offer

HITACHI



We carry a full line of multimeters, oscilloscopes, frequency counters, audio and RF generators, power supplies and accessories.

Just call our Toll-Free number and one of our experts will answer all your questions about test equipment.

**THESE 1981 B&K OSCILLOSCOPES
ARE IN STOCK AND AVAILABLE
FOR IMMEDIATE DELIVERY**



BK PRECISION

- 1479A Dual-Trace 30 MHz
- 1477 Dual-Trace 15 MHz
- 1432 Dual-Trace 15 MHz Portable
- 1476 Dual-Trace 10 MHz
- 1466 Single-Trace 10 MHz
- 1405 Single-Trace 5 MHz
- 1420 Dual-Trace 15 MHz Portable

**CALL FOR OUR
EARLY BIRD SPECIAL LOW PRICE**

**PORTABLE
OSCILLOSCOPES**
BATTERY OPERATED



Non-Linear Systems

Call For Our Prices

MS-15



Single Trace 15MHz

MS-215



Dual Trace 15 MHz

MS-230



Dual Trace 30MHz

FLUKE DIGITAL MULTIMETERS

**Model 8022B:
The Troubleshooter**

\$139

- Six functions
- 3½-digit resolution
- dc voltage
- ac voltage
- dc current
- ac current
- resistance
- diode test
- 0.25% basic dc accuracy
- LCD display
- Overload protection

**Model 8020B:
The Analyst**

\$189



**Model 8024A:
The Investigator**

\$239



NEW

- Seven functions
- dc voltage
- ac voltage
- dc current
- ac current
- resistance
- diode test
- conductance (1/R)
- 3½-digit resolution
- 0.1% basic dc accuracy
- LCD display
- Overload protection
- Two year parts and labor warranty

- Nine functions
- dc voltage
- ac voltage
- dc current
- ac current
- resistance
- diode test
- conductance (1/R)
- logic level and continuity detect
- temperature (K-type thermocouple)
- Peak hold on voltage and current functions
- Selectable audible indicator for continuity or level detection
- 3½-digit resolution
- 0.1% basic dc accuracy
- LCD display
- Overload protection

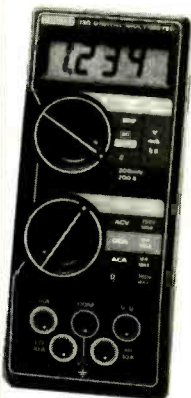

**KEITHLEY MODEL 130
DIGITAL MULTIMETER**

	RANGE	ACCURACY
DC VOLTAGE	200mV, 2V, 20V, 200V, 1000V	.5%
AC VOLTAGE	200mV, 2V, 20V, 200V, 750V	1%
DC CURRENT	2mA, 20mA, 200mA, 2000mA, 10A	2%
AC CURRENT	2mA, 20mA, 200mA, 2000mA, 10A	3%
RESISTANCE	200Ω, 2kΩ, 20kΩ, 200kΩ, 20MΩ	.5%

\$125.

**CALL US
FOR OUR
LABOR DAY
SPECIALS!**

LETTERS

continued from page 22

our members demand, from Pascal programs to home-control, computerized alarm systems, and other practical applications.

We hope to hold meetings monthly at members' homes. Club dues have not been set as yet, as we must find our first how many people are interested in the club. We need ambitious, eager people and welcome all inquiries.

SCOTT SUMMER,
The National Apple Newsletter,
27 Leicester Way,
Pawtucket, RI

RADAR DETECTORS

I would like to reply to the letter in the June 1981 **Radio-Electronics** by Mr. Delton T. Horn. Your magazine is quite excellent, and has no reason to apologize for anything he has commented upon. (1) Computerized ticketing—Big Brother would love that one—its sounds like something that Hilter would have produced. (2) Radar detectors—they have not been shown to be foolproof, and are indeed subject to errors and abuse. Police, being all too human, are all too capable of using radar for harrassment, speed traps, etc. Since the courts tend to view radar evidence as gospel, our only defense is offense: radar detectors. Also: a receiver is still a receiver, whether it provides communication or not. (3) Pay-

TV decoders. Since they are still legal, **Radio-Electronics** has every right to publish anything about them.

I, too, am a concerned electronics technician. My concern is with the government taking more and more control over my life. The "irresponsibility" lies in too much big government.
MARK A. RECOB,
Madison, WI

I agree with your comments. However, pay-TV decoders have been ruled to be illegal devices by several courts. Thus, to make the situation worse, decoders are legal in some states and illegal in others.—Editor

SUPER TWIN LEAD

In reference to Mr. Dennis C. Brown's informative article, "How to Improve UHF Reception," in the July 1981 **Radio-Electronics**, is it possible that neither he nor the Georgia Tech group know of a type of twin lead made by Belden (Belden type 8235), which is rated at 2.2 dB losses per 100 feet at 400 MHz? I believe that the loss is less than 4 dB at 800 MHz. It is 1-kilowatt transmitting lead made primarily for hams, but the cost is about that of shielded UHF lead. I have used it for years and receive 100-mile distant stations on a VHF-UHF antenna. Best of all, it is not affected by rain!

PRESTON C. RICE,
Birmingham, AL

AUDIO-SIGNAL RESTORATION UNIT

After consultation with Mr. Joseph Gorin about his article, "Audio-Signal Restoration Unit" (**Radio-Electronics**, April 1981), I would like to alert those who are building the unit from their own parts stock (as opposed to the prepackaged kits): The unit will *not* work when 4739 preamplifier IC's are substituted for the 739 units required. Many retailers are shipping 4739 IC's from Exar or Raytheon when 739's are requested. Fairchild is the only manufacturer making the 739 at the present time. Using the 4739 will elicit correct operation of the noise-filter part of the circuit—but only silence from the expander!

ALAN J. FRIDLUND,
Martinez, CA

ROBOT-BUILDERS' CLUB

I am hoping to start a club in northern New Jersey/New York City/Long Island for anyone interested in building robots or working with them. I would like to make a list of all the people in those areas who are interested in joining such a club.

Even if you are too far away to attend a meeting, please get in touch with me. At a later time, there might be a club in your area to which I could steer you.

For the presently proposed club, there is as yet no meeting time or place, but we shall probably choose a location in New York City and meet on a week night.

If you have any questions or problems with robots, please write to me; I might be able to help.

DAVID SMITH
4505 Kennedy Blvd.,
North Bergen, NJ

R-E

Designing Digital Systems

Two programmed learning courses:
hardware and software; theory
and application.



Design of Digital Systems - six volumes

ADVANCED COURSE DESIGN OF DIGITAL SYSTEMS

Six large format volumes — each 11 1/4" x 8 1/2"

CONTENTS

The contents of Design of Digital Systems include:

Book 1: Octal, hexadecimal and binary number systems; representation of negative numbers; complementary systems; binary multiplication and division.

Book 2: OR and AND functions; logic gates; NOT, exclusive-OR, NAND, NOR and exclusive-NOR functions; multiple input gates; truth tables; DeMorgan's Laws; canonical forms; logic conventions; Karnaugh mapping; three-state and wired logic.

Book 3: Half adders and full adders; subtractors; serial and parallel adders; processors and arithmetic logic units (ALUs); multiplication and division systems.

Book 4: Flip-flops; shift registers; asynchronous counters; ring, Johnson and exclusive-OR feedback counter; random access memories (RAMs); read-only memories (ROMs).

Book 5: Structure of calculators; keyboard encoding; decoding display data; register systems; control unit; program ROM; address decoding; instruction sets; instruction decoding; control program structure.

Book 6: Central processing unit (CPU); memory organization; character representation; program storage; address modes; input/output systems; program interrupts; interrupt priorities; programming; assemblers; executive programs; operating systems; and time-sharing.

OUR CUSTOMERS

Design of Digital Systems has been bought by more than half the 50 largest corporations in America, and by Motorola, Intel, DEC, National Semiconductor, Fairchild, General Instrument, Hewlett-Packard, Heath Co., M.I.T., NASA, Smithsonian Institute, Bell Telephone Labs. And many, many more, as well as corporations and individuals in over 50 countries.

BASIC COURSE



Digital Computer Logic & Electronics

CONTENTS

Digital Computer Logic and Electronics is designed for the beginner. No mathematical knowledge other than simple arithmetic is assumed, though you should have an aptitude for logical thought. It consists of 4 volumes — each 11 1/4" x 8 1/2" — and serves as an introduction to the subject of digital electronics.

Contents include: Binary, octal and decimal number systems; conversion between number systems; AND, OR, NOR and NAND gates and inverters; Boolean algebra and truth tables; DeMorgan's Laws; design of logical circuits using NOR gates; R-S and J-K flip-flops; binary counters, shift registers and half-adders.

NO RISK GUARANTEE

There's absolutely no risk to you. If you're not completely satisfied with your courses, simply return them to CLJ within 30 days. We'll send you a full refund, plus return postage.

TAX DEDUCTIBLE

In most cases, the full cost of CLJ courses can be a tax deductible expense.

PHONE ORDERS - FREE

To order by phone, call (617) 664-3657 with your credit card information. It won't cost you a dime, because we'll deduct the cost of your call from the price of the courses you order.

TO ORDER BY MAIL

You may use the order form below if you wish, but you don't need to. Just send your check or money order (payable to Cambridge Learning, Inc. to the address below. If you don't use the order form, make sure your address is on your check or the envelope, and write "DDS" (Design of Digital Systems), "DCLJ" (Digital Computer Logic & Electronics), or "both" (both courses) on your check.

Mass. Residents add 5% sales tax. We pay all shipping costs.

We also accept company purchase orders.

AIR MAIL

The prices shown include surface mail postage anywhere in the world. Air mail postage costs an extra \$10 for both courses (10 volumes).

DISCOUNTS

Call or write for details of educational and quantity discounts, and for dealer costs.

SAVE \$5

If you order both courses, you save \$5. Order at no obligation today.

To: Cambridge Learning Inc., 1 Judith Drive, North Reading, MA 01864

Please send me

___ sets of Design of Digital Systems	\$19.95	\$.....
___ sets of Digital Computer Logic & Electronics	\$14.95	\$.....
___ sets of both courses	\$29.90	\$.....

Enclosed is check/money order (payable to Cambridge Learning Inc.) for total \$.....

NAME

ADDRESS

CITY/STATE/ZIP

R10

EQUIPMENT REPORTS

Ford Industries Code-A-Phone 1000 Telephone-Answering Machine



CIRCLE 101 ON FREE INFORMATION CARD

CODE-A-PHONE		1000												
OVERALL PRICE														
EASE OF USE														
INSTRUCTION MANUAL														
PRICE/VALUE														
		1	2	3	4	5	6	7	8	9	10			
		Poor			Fair			Good			Excellent			

FOR YEARS TELEPHONE-ANSWERING MACHINES were used only by businesses, and usually leased from local phone companies. Now privately-owned telephone-answering devices are becoming more common every day.

Certainly among the most easy-to-install—

and use—telephone-answering machines is the *Code-A-Phone 1000*, from Ford Industries, Inc. (5001 S.E. Johnson Creek Blvd., Portland, OR 97222). Although the *Code-A-Phone 1000* is their bottom-of-the-line unit, with a suggested retail price of \$139.95, it has

features not found on more expensive units made by other manufacturers.

The *Code-A-Phone 1000* operates on AC power (it uses a UL-approved wall-plug transformer), so you don't need to worry about dead batteries. It uses a modular plug to connect to the phone line (the connection is FCC-approved). If you have the older 4-prong jacks, adapters are available from Ford Industries or your local electronics store.

The beige plastic *Code-A-Phone 1000* case has brown trim and silver knobs. The entire unit weighs only five pounds, and measures 12 × 9 × 3½ inches. All controls are "human-engineered" for very simple use. Both the wall-plug transformer and the modular phone plug are at the ends of cables that are longer than six feet each, so you should have no difficulty in finding a suitable location for the unit.

Among the unexpected features for a low-price telephone-answering machine are a call-counter, ring selection, built-in microphone, variable announcement length, selective mes-

continued on page 32



You've turned a good idea into a piece of equipment—now you need a good enclosure. Here's how PacTec can help you with our versatile enclosures:

- Attractive yet inexpensive.
- Durable ABS construction.
- Many sizes, colors, accessories.
- Built in bosses and slots speed component mounting.
- Available off-the-shelf from single unit to production quantities. See them at your PacTec Distributor. And ask him for your free catalog.

PACITEC Corp.
subsidiary of La France Corp.
Enterprise and Executive Avenues
Philadelphia, PA 19153 (215) 365-8400



CIRCLE 35 ON FREE INFORMATION CARD

PRINTED CIRCUIT KITS MAKE CARDS QUICKLY



ONLY Vector kits contain:

- Positive photo-resist coated AND uncoated copper laminate—no messy photo-reversal—no spraying, dipping, or baking.
 - 4 types of art aids: rub transfers, ink, tape, cut and peel—use 1 or all.
 - 1:1 circuit art rub transfers—IC sets, pads, lines, connectors, symbols, letters, and numbers.
 - Everything included—just add water and sunlamp or bright sunshine.
 - Liquid etchant and developer—no dry chemical mixing problems.
- AND
- Process choices—make circuit on copper and etch for 1 card. Make circuit on film, expose, develop and etch for 1 or many cards.

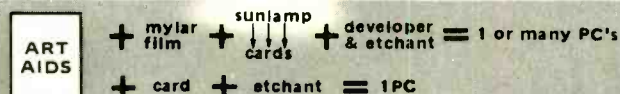

32XA-1 kit makes 7 PC cards, \$30.80, 32X-1 starter kit makes 2 cards, \$17.05
If not available locally factory order—include \$3.00 shipping, U.S. only
Prices subject to change without notice

510177

Vector Electronic Co., 12460 Gladstone Av., Sylmar, CA 91342

CIRCLE 24 ON FREE INFORMATION CARD

EQUIPMENT AND TRAINING NO OTHER SCHOOL CAN MATCH.

**NTS HOME TRAINING INVITES YOU TO EXPLORE MICROCOMPUTERS,
DIGITAL SYSTEMS AND MORE, WITH STATE-OF-THE-ART EQUIPMENT
YOU ASSEMBLE AND KEEP.**

Without question, microcomputers are the state of the art in electronics. And NTS is the only home study school that enables you to train for this booming field by working with your own production-model microcomputer.

We'll explain the principles of troubleshooting and testing your microcomputer and, best of all, we'll show you how to program it to do what you want.

You'll use a digital multimeter, a digital logic probe and other sophisticated testing gear to learn how to localize problems and solve them.

Send for the full color catalog in the electronics area of your choice—discover *all* the advantages of home study with NTS!

NTS also offers courses in Auto Mechanics, Air Conditioning and Home Appliances. Check card for more information.

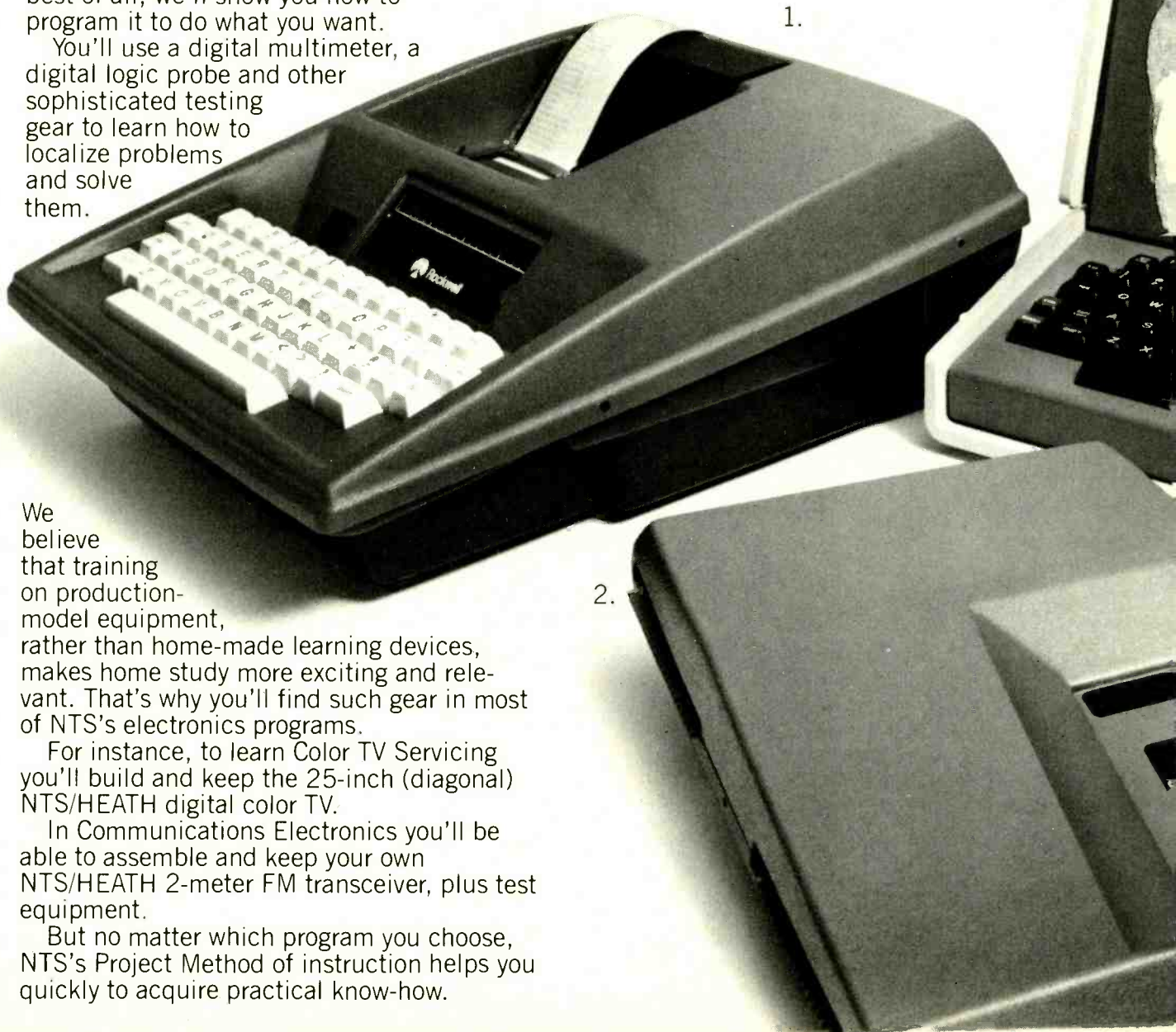

We believe that training on production-model equipment, rather than home-made learning devices, makes home study more exciting and relevant. That's why you'll find such gear in most of NTS's electronics programs.

For instance, to learn Color TV Servicing you'll build and keep the 25-inch (diagonal) NTS/HEATH digital color TV.

In Communications Electronics you'll be able to assemble and keep your own NTS/HEATH 2-meter FM transceiver, plus test equipment.

But no matter which program you choose, NTS's Project Method of instruction helps you quickly to acquire practical know-how.



Simulated TV Reception

4



3.

1. The NTS/Rockwell AIM 65 Microcomputer A single board unit with on-board 20 column alphanumeric printer and 20 character display. A 6502-based unit 4K RAM, expandable.
2. The NTS/KIM-1 Microcomputer A single board unit with 6 digit LED display and on-board 24 key hexadecimal calculator-type keyboard. A 6502 based microcomputer with 1K RAM, expandable.
3. The NTS/HEATH H-89 Microcomputer features floppy disk storage, "smart" video terminal, two Z80 micro-processors, 16K RAM memory, expandable to 48K.
4. The NTS/HEATH GR-2001 Digital Color TV (25" diagonal) features specialized AGC-SYNC muting, filtered color and new solid-state high voltage tripler rectifier.

NTS NATIONAL TECHNICAL SCHOOLS

TECHNICAL TRADE TRAINING SINCE 1905
Resident and Home-Study Schools
4000 SO. FIGUEROA ST., LOS ANGELES, CA. 90037

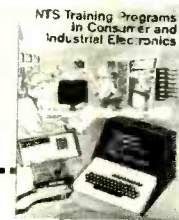

NATIONAL TECHNICAL SCHOOLS

4000 South Figueroa Street, Dept. 206-091
Los Angeles, California 90037

Please rush FREE color catalog on course checked below

- | | |
|---|---|
| <input type="checkbox"/> MicroComputers/MicroProcessors | <input type="checkbox"/> Auto Mechanics |
| <input type="checkbox"/> Communications Electronics | <input type="checkbox"/> Air Conditioning |
| <input type="checkbox"/> Digital Electronics | <input type="checkbox"/> Home Appliances |
| <input type="checkbox"/> Industrial Technology | <input type="checkbox"/> Color TV Servicing |

Name _____ Age _____

Address _____

Apt. _____ City _____

State _____ Zip _____

- Check if interested in G.I. information.
 Check if interested ONLY in classroom training in Los Angeles.

EQUIPMENT REPORTS

continued from page 27

sage erase, auto-stop, fast-forward, and a monitor. Let's discuss those in turn.

Most answering machines in the low-price range don't have a call-counter, although some indicate when the unit has received at least one message, using a "flag" or a light. The *Code-A-Phone 1000* has a window at the top of the unit through which you see a number (0-20). If you've received four calls, for example, the number shown is 4. The counter also tells you which call you're listening to on playback.

The ring-select feature allows you to choose which ring activates the device, from the first to the fourth, using a simple screwdriver

adjustment located at the bottom of the unit. This feature lets you leave the *Code-A-Phone 1000* on most of the time, with the option of answering personally if it is convenient. To do that, set it to answer on the third or fourth ring. On the other hand, if you'll only be using the unit when you're away, set it to answer on the first or second ring.

The built-in condenser microphone makes it easy to change your outgoing message, and eliminates another plug and cord as well as the danger of losing the microphone.

Since it is so easy to change, the *Code-A-Phone 1000* allows you to set the length (in seconds) of the outgoing message. That eliminates having to "fill" a predetermined time period, or to have a long silence after your outgoing message before the tone signals the caller to start talking. The *Code-A-Phone 1000*

outgoing announcement can be set for 5, 10, 15, or 20 seconds with a well-marked lever control, and is easily reviewed using the CHECK function on the main selector knob.

A source of confusion on many answering machines is the "old" messages. New messages, of course, automatically erase old ones as they record. But if previously you had, say, seven old messages, but only three new ones this time, the last four of the old messages are still on the tape. As you play back your messages, you can hear a message that was recorded days or weeks before and not realize it's an old message, since people rarely identify the time or date of their call. With the *Code-A-Phone 1000*, you can hold down the REWIND and MESSAGE ERASE key-type pushbuttons at the same time, erasing all messages back from that point on the tape. You can also erase while in the fast-forward mode.

Most answering machines have a fast-forward control, so that on playback of your messages you can quickly move ahead past short messages or calls where people hung-up without leaving any message. A nice feature of the *Code-A-Phone 1000* push-button FAST-FORWARD switch is that it only needs to be pressed and released. It latches, moves ahead to the next message, and resumes normal speed automatically. If you wish, you can hold it down and move forward to whatever message you wish by watching the counter advance.

To monitor incoming calls, just turn up the volume control and you can hear the caller speaking. If you wish to speak directly to the caller, just pick up your telephone handset; it is not necessary to turn off the *Code-A-Phone 1000*. The *Code-A-Phone 1000* will record both sides of the conversation until it shuts off. (Incoming message length is fixed at 30 seconds, for 20 messages total.) Your caller will have no trouble hearing you (although your voice's volume level will be a little below normal). When the *Code-A-Phone 1000* turns off, continue your conversation normally.

Using the *Code-A-Phone 1000* is easier than using any answering machine I've owned previously, and I've had several. When you leave the house, just move the main control knob to ANSWER—that's all! When you return, if the counter has not advanced, just turn the main control knob to OFF. If the counter has advanced, move the control to PLAYBACK, press the REWIND key until the counter is back to where it was when you left (usually at zero) and press the START button. Unlike some machines, only the incoming message is heard; you do not have to listen to your outgoing message over and over. Since the *Code-A-Phone 1000* has automatic level control on record, you do not need to adjust the volume control when you leave.

The booklet that accompanies the 1000 is very easy to follow, with large well-labeled photos and step-by-step instructions.

The only suggestion I could make to improve the *Code-A-Phone 1000* would be to add a small light to show when the unit is in the standby condition (answer or playback). That condition is easy to overlook, since the round control knob has only a short pointer line to indicate position, and the line is not visible from a distance. I added an LED to mine, and now I can tell from across the room when the unit is on. However, be aware that if you make this change yourself, you could void the 90-day labor and 1-year parts warranty on your *Code-A-Phone 1000*.

R-E

ADVANCE IS PROUD
TO INTRODUCE



Non-Linear Systems

High Quality Oscilloscopes
Backed by
A Two-Year Warranty

*Exception: model MS-230 is slightly deeper, at 8.6", and heavier, at 3.6 lbs.)

MODEL	VERTICAL BANDWIDTH	DEFLECTION FACTOR	TIME BASE
MS-230	30MHz	10mV to 50V/div. 12 Ranges	0.05µ Sec to 0.2 Sec/div. 21 Ranges
MS-215	15MHz	10mV to 50V/div. 12 Ranges	0.1µ Sec to 0.5 Sec. 21 Ranges
MS-15	15MHz	10mV to 50V/div. 12 Ranges	0.1µ Sec to 0.5 Sec. 21 Ranges

MS 230



MS 215



Non-Linear Systems' trio of mini-oscilloscopes are accurate, affordable, portable. And there's one to match nearly every budget and need. Standard features on all models include an input impedance of 1 megohm with 50 pF; maximum input voltage of 350 V; trigger modes in auto, internal, external and line; slope that's + or - selectable; graticule (4x5 division of 0.25" each); dual power sources operating either internally from rechargeable lead acid batteries or externally from 115 VAC or 230 VAC (50-60 Hz) via plug-in transformer; handy size (2.9"H x 6.4"W x 8.0"D) and weighs just 3 lbs.*

Check the chart below for details of model features and specifications.

MS 15



The remarkable Touch Test 20 DMM. With the Touch Test 20 Non-Linear Systems introduces the 2 lb. 4 oz. test lab. Now, with 20 key test functions at your fingertips (plus the ability to measure 10 electrical parameters and 44 ranges), you can take one lab to the field instead of a cumbersome collection of individual testers.

The new Touch Test 20 D M M features:

- Built in temperature measurement (including probe: F° and C°)
- Capacitance measurement
- DC Voltage (200 MV - 1000V)
- AC Voltage (200 MV - 1000V)
- DC Current (200 µA - 10A)
- AC Current (200 µA - 10A)
- Resistance (200 Ω - 20MΩ)
- Diode Test

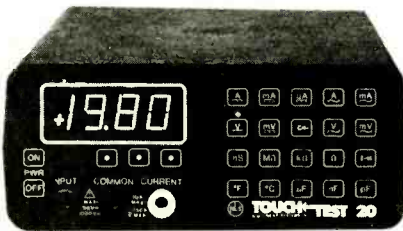

Call For
Special Introductory
Price Offer

ADVANCE
ELECTRONICS

THE TEST EQUIPMENT
SPECIALISTS

TOLL FREE HOT LINE
800-223-0474



54 WEST 45th STREET.



NEW YORK, N.Y. 10036 212-687-2224

**The Microperipheral Corporation
Microconnection Modem**



CIRCLE 102 ON FREE INFORMATION CARD

Micro Corp.	MODEM									
OVERALL PRICE	█	█	█	█						
EASE OF USE	█	█	█	█	█	█	█	█	█	█
INSTRUCTION MANUAL	█	█	█	█	█	█	█	█	█	█
PRICE/VALUE	█	█	█	█	█	█	█	█	█	█
	1	2	3	4	5	6	7	8	9	10
	Poor		Fair		Good		Excellent			

A WHOLE NEW AREA OF INTEREST IS OPENING in the personal computing field—telecommunications, the transfer of computer data over telephone circuits. With a terminal or computer and a modem to interface it to a

telephone line, you can transmit electronic mail in the form of letters or messages using computerized community bulletin boards and acquire material from time-sharing services. You can have access to computerized data bases, up-to-date news from the wire services, financial information, and stock market data. You can, in effect, have your computer talk to another computer!

If you have a Radio Shack *TRS-80* you would normally need an expansion interface with an RS-232 serial interface and a modem to join the telecommunications world. That would cost almost \$600. (And a lot more if you add a disk and more memory!) However, for about \$250 you can purchase the *Microconnection*, a 300-baud modem with an RS-232 interface and several additional features as well.

The *Microconnection* is an FCC-approved "direct-connect" modem. It plugs into both your phone line and the *TRS-80* keyboard. No expansion interface is required, and the *Microconnection* has six screw-terminals and an RS-232 output connector on the back for a multitude of uses. No modification of any kind to the *TRS-80* is required. No power is drawn from the *TRS-80*, since the *Microconnection* has its own power supply fed by a wall-plug transformer. The necessary software—a "dumb terminal" machine-language program (S80)—is supplied on cassette. Extensive optional software is available to make your *TRS-80* a "smart-terminal," allowing the transfer of programs and offering some of the power of disk-based systems.

The *Microconnection* measures just 7½ × 4 × 2 inches and weighs less than two pounds. Two large circuit boards are housed in a two-

piece black wrinkle-finish metal case. White silk-screened lettering identifies the two red LED's that protrude from the top and shows the settings for the two front-mounted push-switches. There are two switches, and they are the only controls. One is set for SIMPLEX (one-way) or DUPLEX (two-way) communication; the other is placed in the VOICE position for normal telephone use, or DATA for modem use. One LED is a POWER ON indicator. The other LED lights only when the CARRIER (signal) is being transmitted.

Installation is simple. With your *TRS-80* off, you push the connector (at the end of a 12-inch ribbon-cable) onto the card-edge at the back of the keyboard unit. If you have an expansion interface, the connector pushes onto the card-edge of the screen printer port. The *Microconnection* now plugs into the phone line using the modular plug (at the end of a six-foot telephone cord that extends from the rear of the *Microconnection*). That plug mates with the standard telephone RJ-11 modular jack, using a duplex jack (such as Radio Shack 279-357). Other adapters may be required if you have older 4-prong telephone plugs.

The RS-232, DB-25 female connector on the back of the *Microconnection* can be used for a serial printer, plotter, graphic display, another computer, or any other RS-232 driven device.

The excellent, detailed manual (that includes several photos, which is unusual in documentation for low-priced peripherals) guides you through the connection procedure, as well as the loading and operation of the software program. You'll need to learn a few new commands using UP-ARROW and SHIFT keys. There

continued on page 36



**RCA Receiving Tubes-
for one-trip servicing.**

Most callbacks aren't caused by bad servicing. Components are the reason.

That's why you need receiving tubes you can trust, dependable receiving tubes from RCA. We offer over 1,000 types—all produced to exacting specifications.

For miniatures, Novars, Compactrons, Nuvistors, Glass Tubes, Metal Tubes and more, count on your RCA Distributor. He's got the tubes that help you finish the job in just one trip.

Increase your profits with RCA service aids and sales promotion aids.

See your local RCA Tube Distributor for RCA's technical guides, service tools and tube caddies. They all make your service work faster and easier while RCA's in-store signs and eye-catching displays promote your business professionally.

RCA Receiving Tubes



RCA Distributor & Special Products Division, Deptford, N.J. 08096

TWELVE STRONG HEATH/ZENITH YOUR

Pick a strong partner

A computer purchase is the beginning of a long term partnership between you and the people you buy from. Your ongoing need for software and accessories requires a partner who will stand by you with a growing line of products. And nowhere will you find a more complete line of hardware, software and accessories than at your Heathkit Electronic Center. Here are twelve strong reasons to make Heath/Zenith your partner.

1. The All-In-One Computer

The heart of the Heath/Zenith line is the stand-alone *89 Computer*. It's a complete system with built-in 5¼-inch floppy disk drive, professional keyboard and keypad, smart video terminal, two Z80 microprocessors, and two RS-232C serial I/O ports. It comes with 16K RAM, expandable to 64K.

2. Peripherals

These include the popular *Heath/Zenith 19 Smart Video Terminal*, loaded with professional features. And the *14 Line Printer*, priced as low as \$495. Other printer brands are on display, including high-speed, typewriter-quality printers.



3. Software

Word processing, includes reliable, easy-to-use Zenith Electronic Typing and powerful, full-featured WORDSTAR.

Small Business Programs, feature General Ledger and Inventory Control.

HUG, Heath Users' Group, offers members a library of over 500 low-cost programs for home, work or play.

4. Programming Languages



For your own custom programs, Microsoft languages are available in BASIC (compiler and interpreter), FORTRAN and COBOL.

5. Operating Systems

Three versatile systems give you the capability to perform your specific tasks.

CP/M by Digital Research makes your system compatible with thousands of popular CP/M programs.

UCSD P-System with Pascal is a complete program development and execution environment.

HDOS, Heath Disk Operating System gives you a sophisticated, flexible environment for program construction, storage and editing.

6. Utility Software

Expand the performance range of your computer with a broad selection of utility tools, including the best of *Digital Research* and the complete line of innovative *Softstuff* products.

7. Disk Systems

The 8-inch Heath/Zenith 47 Dual Disk System adds over 2 megabytes of storage to your



89 Computer. Diskettes are standard IBM 3740 format, double-sided, double-density.

The 5¼-inch 87 Dual Disk System adds 200K bytes of storage to your 89. Both disk systems feature read/write protection and easy plug-in adaptability.

8. Self-Study Courses

Learn at your own pace with *Programming Courses* that teach you to write and run your own programs in Assembly, BASIC, Pascal or COBOL.

A course on *Computer Concepts for Small Business* gives you the understanding to evaluate the ways a computer can benefit your business.

Personal Computing is a complete introduction to the fundamentals for the novice. Every Heathkit/Zenith course is professionally designed for easy, step-by-step learning.

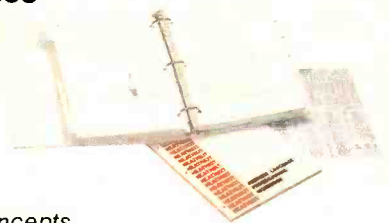

All Heath/Zenith Computer Products are available completely assembled and tested for commercial use. Or in easy-to-build, money-saving kits.

REASONS TO MAKE COMPUTER PARTNER

9. Expansion Options

Communicate with the outside world through a *Three-port EIA RS-232C Serial Interface*.

Expand RAM to 64K with easy-to-install *expansion chips*.

10. Accessories



Your Heathkit Electronic Center has the latest in modems, black-and-white and color video monitors, computer furniture and a full line of supplies, accessories, books and parts.

11. Service

No one stands by you like Heath/Zenith. We help you get your system up and running smoothly. Service is available from trained technicians, over the phone or at one of 56 Heathkit Electronic Centers.



12. Value

Your money buys you more because Heath/Zenith prices are among the industry's most competitive. Make your own comparison and find out how much you can save.

Complete, integrated computer hardware and software, designed to serve you and to grow with you — that's what to look for in a strong partner. And with Heath/Zenith you get it all under one roof.

All at your Heathkit Electronic Center

Pick the store nearest you from the list at right. And stop in today for a demonstration of the Heath/Zenith 89 Computer System. If you can't get to a store, send \$1.00 for the latest Heathkit® Catalog and the new Zenith Data Systems Catalog of assembled commercial computers. Write to Heath Co., Dept. 020-814, Benton Harbor, MI 49022.

Visit Your Heathkit Electronic Center*

where Heath/Zenith Products are displayed, sold and serviced.

PHOENIX, AZ 2727 W. Indian School Rd. 602-279-6247	MISSION, KS 5960 Lamar Ave. 913-362-4486	CLEVELAND, OH 28100 Chagrin Blvd. 216-292-7553
ANAHEIM, CA 330 E. Ball Rd. 714-776-9420	LOUISVILLE, KY 12401 Shelbyville Rd. 502-245-7811	COLUMBUS, OH 2500 Morse Rd. 614-475-7200
CAMPBELL, CA 2350 S. Bascom Ave. 408-377-8920	KENNER, LA 1900 Veterans Memorial Hwy. 504-467-6321	TOLEDO, OH 48 S. Byrne Rd. 419-537-1887
EL CERRITO, CA 6000 Potrero Ave. 415-236-8870	BALTIMORE, MD 1713 E. Joppa Rd. 301-661-4446	WOODLAWN, OH 10133 Springfield Pike 513-771-8850
LA MESA, CA 8363 Center Dr. 714-461-0110	ROCKVILLE, MD 5542 Nicholson Lane 301-881-5420	OKLAHOMA CITY, OK 2727 Northwest Expressway 405-848-7593
LOS ANGELES, CA 2309 S. Flower St. 213-749-0261	PEABODY, MA 242 Andover St. 617-531-9330	FRAZER, PA 630 Lancaster Pike (Rt. 30) 215-647-5555
POMONA, CA 1555 N. Orange Grove Ave. 714-623-3543	WELLESLEY, MA 165 Worcester Ave. 617-237-1510	PHILADELPHIA, PA 6318 Roosevelt Blvd. 215-288-0180
REDWOOD CITY, CA 2001 Middlefield Rd. 415-365-8155	DETROIT, MI 18645 W. Eight Mile Rd. 313-535-6480	PITTSBURGH, PA 412-824-3564
SACRAMENTO, CA 1860 Fulton Ave. 916-486-1575	E. DETROIT, MI 18149 E. Eight Mile Rd. 313-772-0416	WARWICK, RI 3482 Wm. Penn Hwy. 401-738-5150
WOODLAND HILLS, CA 22504 Ventura Blvd. 213-883-0531	HOPKINS, MN 101 Shady Oak Rd. 612-938-6371	OALLAS, TX 2715 Ross Ave. 214-826-4053
DENVER, CO 5940 W. 38th Ave. 303-422-3408	ST. PAUL, MN 1645 White Bear Ave. 612-778-1211	HOUSTON, TX 1704 W. Loop N. 713-869-5263
AVON, CT 395 W. Main St. (Rt. 44) 203-678-0323	BRIDGETON, MO 3794 McKelvey Rd. 314-291-1850	SAN ANTONIO, TX 7111 Blanco Road 512-341-8876
HIALEAH, FL 4705 W. 16th Ave. 305-823-2280	OMAHA, NE 9207 Maple St. 402-391-2071	MIDVALE, UT 58 East 7200 South 801-566-4626
PLANTATION, FL 7173 W. Broward Blvd. 305-791-7300	ASBURY PARK, NJ 1013 State Hwy. 35 201-775-1231	ALEXANDRIA, VA 6201 Richmond Hwe. 703-765-5515
TAMPA, FL 4019 W. Hillsborough Ave. 813-886-2541	FAIR LAWN, NJ 35-07 Broadway (Rt. 4) 201-791-6935	VIRGINIA BEACH, VA 1055 Independence Blvd. 804-460-0997
ATLANTA, GA 5285 Roswell Rd. 404-252-4341	AMHERST, NY 3476 Sheridan Dr. 716-835-3090	SEATTLE, WA 505 8th Ave. N. 206-682-2172
CHICAGO, IL 3462-66 W. Devon Ave. 312-583-3920	JERICHO, L.I. NY 15 Jericho Turnpike 516-334-8181	TUKWILA, WA 15439 53rd Ave. S. 206-246-5358
DOWNERS GROVE, IL 224 Ogden Ave. 312-852-1304	ROCHESTER, NY 937 Jefferson Rd. 716-424-2560	MILWAUKEE, WI 5215 W. Fond du Lac 414-873-8250
INDIANAPOLIS, IN 2112 E. 62nd St. 317-257-4321	N. WHITE PLAINS, NY 7 Reservoir Rd. 914-761-7690	

Prices and specifications subject to change without notice.

*Units of Veritechnology Electronics Corporation in the U.S.

HEATH/ZENITH

Your strong partner

EQUIPMENT REPORTS

continued from page 33

are about 200 free "community bulletin board systems" (CBBS) around the country, with more popping up all the time. Although those CBBS's use various home computers (TRS-80, Apple, PET, OSI, Heath, and others) the 300-baud ASCII communication standard lets you "microspend" with any of them! Each contains "HELP" commands to document their own operation. Unfortunately, although a transmission standard (Bell System 103 compatible) exists, individual CBBS's may use different operational commands. A "G" on one means "goodbye", while another uses a "T" for "terminate". Worse yet, the same com-

mand letter can mean entirely different things on different CBBS's ("E" can mean "EDIT" or "EXIT", for example). After getting acquainted with the *Microconnection* and CBBS operations, you're ready for the "big time" with *THE SOURCE* or *MicroNET*, both of which are huge time-sharing systems available by subscription.

I found CompuServe's *MicroNET* an entire world of its own! It's like a gigantic cavern with bunches of caves in any direction—but that's a whole article in itself. *MicroNET* is very well documented with a 70-page two-color manual describing the commands, your own personal 125K file area, the bulletin board, games, and various services and directories. *MicroNET* now also offers a stock-quoting service, electronic mail, and news that comes right off the wire services. Radio Shack stores sell member-

ships to *MicroNET* for \$29.95, including the software and one hour of free connect time (which is regularly \$5 an hour). The same membership is available from The Microperipheral Corporation.

But communications using the *Microconnection* are not limited to the phone lines. If you are a ham radio operator, you can transmit over the air in ASCII code to another station similarly equipped. The *Microconnection* manual describes the connections (including automatic transmitter turn-on with the push-to-talk line) using four of the six screw terminals on the back of the device.

Also, since ASCII is the "universal" code of computers, it's possible to record programs on cassette tape. Three of the rear screw-terminals are used to connect to your cassette recorder for recording and playback of ASCII tapes at 300 baud.

After several weeks of using the *Microconnection* on several CBBS's and *MicroNET*, I feel I've only begun to exercise its potential. The *Microconnection* has operated flawlessly, dutifully obeying all my commands (even the wrong ones) as I aimlessly wandered in awe through various *MicroNET* services (and various bulletin boards within *MicroNET*).

Technical specifications for the *Microconnection* are available from the manufacturer, The Microperipheral Corporation, P.O. Box 529, Mercer Island, WA 98040. The *Microconnection* for the TRS-80 computer sells for \$249.00. **R-E**

ADVANCE IS PROUD TO INTRODUCE the KEITHLEY Line of High Quality Digital Multimeters Featuring The New 130 Hand-Held DMM

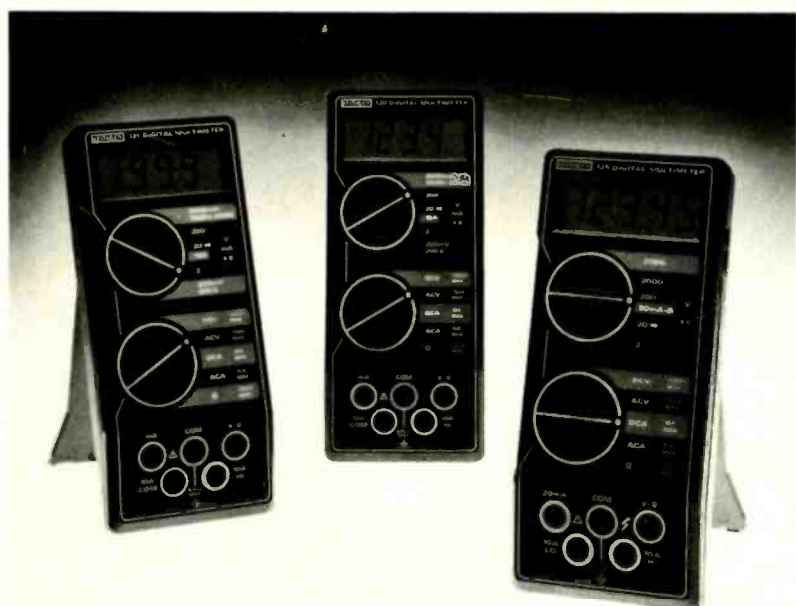

Rugged DMMs from Keithley — all feature large, bright LCD display, easy-to-use rotary switches, externally accessible battery and fuse, 10A current range, diode test capability, low battery indicator, cushioned components.

Model 131. Similar to Model 130, with increased accuracy **\$134**

Model 130. Our most popular model, the price/performance champ. **\$125**

Model 135. First 4½-digit DMM with hand-held convenience . . . **\$219**

MODEL	ACCURACY					SENSITIVITY				
	DCV	DCA	ACV	ACA	Ω	DCV	DCA	ACV	ACA	Ω
130	0.5%	1%	1%	2%	0.5%	100μV	1μA	100μV	1μA	100mΩ
131	0.25%	0.75%	1%	2%	0.2%	100μV	1μA	100μV	1μA	100mΩ
135	0.05%	0.5%	1%	1.5%	0.2%	100μV	10μA	100μV	1μA	100mΩ

Case \$10.00 Shipping \$3.00

THE TEST EQUIPMENT SPECIALISTS
TOLL FREE HOT LINE
800-223-0474

54 WEST 45th STREET, NEW YORK, N.Y. 10036 212-687-2224

ADVANCE ELECTRONICS

Grove Enterprises Shortwave/Longwave Tuner



CIRCLE 103 ON FREE INFORMATION CARD

GROVE	LW/SW TUNER										
OVERALL PRICE											
EASE OF USE											
INSTRUCTION MANUAL											
PRICE/VALUE											
	1	2	3	4	5	6	7	8	9	10	
	Poor			Fair				Good			Excellent

WHILE A NUMBER OF RECEIVER PRESELECTORS and tuners are on the market, the Grove Enterprises *Shortwave/Longwave Tuner* is the first to tune the entire 10 kHz—30 MHz frequency range.

A multi-position rotary switch selects a resonant inductor that is placed in series with a tuning capacitor (TUNE control). That circuit optimizes coupling between the antenna and the receiver at the desired frequency. Two buttons are used to connect one of two antennas to one of two receivers. That lets you select

continued on page 81

Light-torque rotary switches make the LM-3.5A DMM as easy to operate as it is to carry.

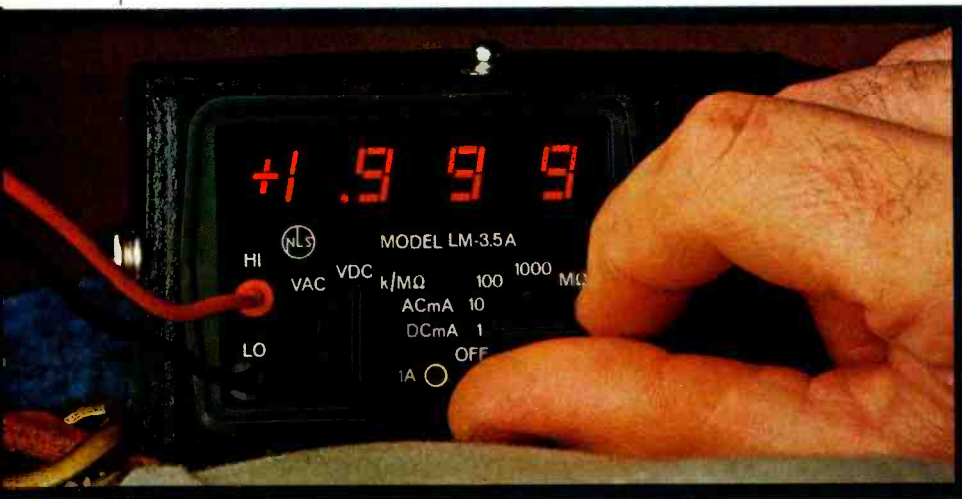

On a benchtop or a belt, over a shoulder or in a tool kit, the LM-3.5A DMM, and its LCD counterpart, the LM-350, are ready to go when you are.

Convenience. That's the key to Non-Linear Systems' best-selling LM-3.5A. A high-performance, competitively-priced, all-purpose mini DMM. Convenience from light-torque rotary switches. So operation's a cinch. Convenience from bold, bright LEDs. For instant, accurate, numeric answers. Unlike some competitive meters, the LM-3.5A features both vertical and horizontal readings. And an optional leather carrying case with belt loops and shoulder strap assures hands-free operation.

At 9.2 oz., the LM-3.5A is portability at its best. There's more. The LM-3.5A is a 3½-digit DMM. Features 2,000 counts per range — 100% over-ranging. Result? Increased accuracy and resolution between readings of 999-2,000. It also reduces the amount of range shifting when measuring near 1,000.

Troubleshooters swear by it. Repairmen find the LM-3.5A works wonders on tvs, business machines, even cameras. Checks all quiescent AC and DC voltage values. Spots current drains. Measures the resistance of suspect components. Quickly and precisely.

Other DMMs to match your needs. The LM-3.5A is just one in a full series of 3 to 4-digit DMMs. If you need LCD convenience for measurements outdoors, we market the LM-350, among others. You don't pay for true RMS capabilities you don't need. But if you do need true RMS readings, Non-Linear Systems can oblige.

FM-7. The bantam frequency meter. Portability teams with performance in the FM-7. The smallest, 7-digit, 60-MHz, battery or AC line-operated instrument available.



Operator convenience is the key to our line of frequency and temperature meters, too. Pictured left to right, SC-5 prescaler, FM-7 frequency meter, LED format LT-3 digital temp meter, and its LCD cousin, the LM-350. Top, the MLB-1 digital logic probe.

Hobbyists, radio and tv studios, phone companies and the military all depend on the versatile FM-7. Whether the job calls for calibrating fixed, variable frequency or voltage-controlled oscillators, checking flowmeters, high-speed photocell counters, or setting the IF or heterodyne frequency in communications equipment, the FM-7 is a standout performer.

SC-5 Prescaler. Top range booster. This 512-MHz, battery or AC line-operated prescaler was developed to extend the frequency range of the FM-7 from 60 to 512 MHz. Adapts to most other frequency meters, too.

LM-3.5A at a glance.

DC Volts	1 to 1,000, 4 ranges
AC Volts	1 to 750, 4 ranges
Kilohms	1 to 10000, 5 ranges
AC/DC Current	1 mA to 1A, 4 ranges
Polarity Selection	Automatic
Readout	0.3" Red LED
Size	1.9" H x 2.7" W x 4.0" D
Weight	9.2 oz (batteries installed)
Power	3 type AA rechargeable Nicaid batteries and charger
Price	\$165.85

LT-3 Digital Temp Meter. Featuring 0.1° resolution and high accuracy, the 3½-digit, 2,000 count full scale LT-3 is indispensable for home or industry. Checks everything from thermostats to appliances. Even monitors critical operations like photoprocessing and electroplating.

The LT-3 can be supplied with any of eight thermistor and RTD temp sensors to read ranges of 0-100°C, 32-199.9°F, or 0-199°C or F.

Work outdoors? Then the LT-31 (LCD format) is the ticket.

Get the word on us. We offer a full lineup of convenient, competitively-priced products. From DMMs, frequency and temp meters to miniscopes and DPMs.

For further technical information or the names of your nearest distributors, contact Non-Linear Systems Inc., 533 Stevens Ave., Solana Beach, CA 92705. Telephone (714) 755-1134. TWX 910-322-1132.



Non-Linear Systems, Inc.

Specialists in the science of staying ahead.

© 1981 Non-Linear Systems, Inc.

**Learning
electronics
is no picnic.**

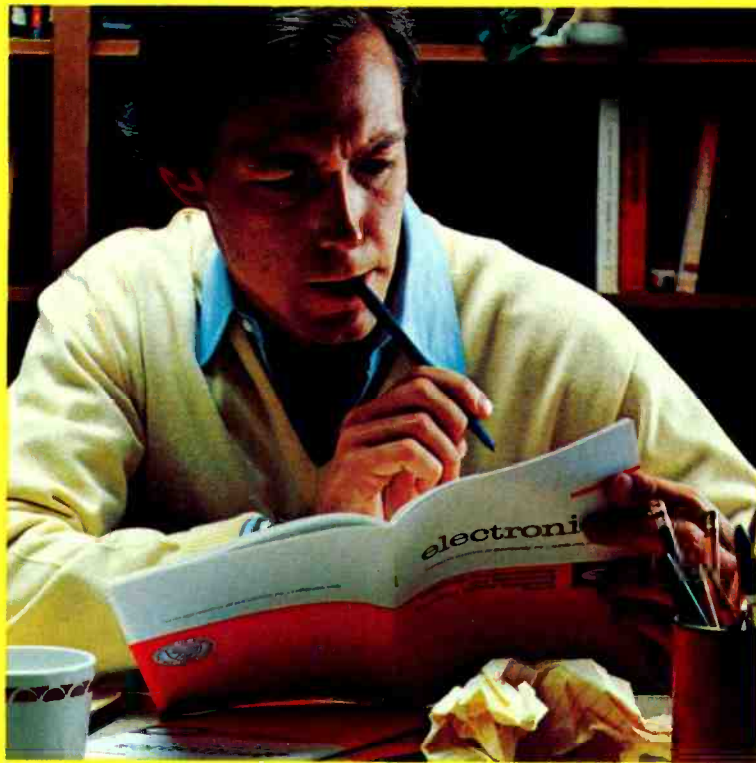

**At any level it
takes work and
a few sacrifices.
But with CIE,
it's worth it.**

Whoever said, "The best things in life are free," was writing a song, not living a life. Life is not just a bowl of cherries, and we all know it.

You fight for what you get, You get what you fight for. If you want a thorough, practical, working knowledge of electronics, come to CIE.

You can learn electronics at home by spending just 12 hard-working hours a week, two hours a day. Or, would you rather go bowling? Your success is up to you.

At CIE, you *earn* your diploma. It is not handed to you simply for putting in hours. But the hours you do put in will be on your schedule, not ours. You don't have to go to a classroom. The classroom comes to you.

Why electronics training?

Today the world depends on technology. And the "brain" of technology is electronics. Every year, companies the world over are finding new ways to apply the wonders of electronics to control and program manufacturing, processing...even to create new leisure-time products and services. And the more electronics applications there are, the greater the need will be for trained technicians to keep sophisticated equipment finely tuned and operating efficiently. That means career opportunities in the eighties and beyond.

Which CIE training fits you?

Beginner? Intermediate? Advanced? CIE home study courses are designed for ambitious people at all entry levels. People who may have:

1. No previous electronics knowledge, but do have an interest in it;
2. Some basic knowledge or experience in electronics;
3. In-depth working experience or prior training in electronics.

You can start where you fit and fit where you start, then go on from there to your Diploma, FCC License and career.

Many people can be taught electronics.

There is no mystery to learning electronics. At CIE you simply start with what you know and build on it to develop the knowledge and techniques that make you a specialist. Thousands of CIE graduates have learned to master the simple principles of electronics and operate or maintain even the most sophisticated electronics equipment.

CIE specializes exclusively in electronics.

Why CIE? CIE is the largest independent home study school that specializes exclusively in electronics. Nothing else. CIE has the electronics course that's right for you.

Learning electronics is a lot more than memorizing a laundry list of

facts about circuits and transistors. Electronics is interesting! It is based on recent developments in the industry. It's built on ideas. So, look for a program that starts with ideas and builds on them. Look to CIE.

Programmed learning.

That's exactly what happens with CIE's Auto-Programmed® Lessons. Each lesson uses famous "programmed learning" methods to teach you important principles. You explore them, master them completely, before you start to apply them. You thoroughly understand each step before you go on to the next. You learn at your own pace.

And, beyond theory, some courses come fully equipped with electronics gear (the things you see in technical magazines) to actually let you perform hundreds of checking, testing, and analyzing projects.

Experienced specialists work closely with you.

Even though you study at home, you are not alone! Each time you return a completed lesson, you can be sure it will be reviewed, graded and returned with appropriate instructional help. When you need additional individual help, you get it fast and in writing from the faculty technical specialist best qualified to

answer your question in terms you can understand.

CIE prepares you for your FCC License.

For some jobs in electronics, you must have a Federal Communications Commission (FCC) License. For others, some employers tend to consider your license a mark in your favor. Either way, your license is government-certified proof of your knowledge and skills. It sets you apart from the crowd.

More than half of CIE's courses prepare you to pass the government-administered exam. In continuing surveys, nearly 4 out of 5 graduates who take the exam get their licenses! You can be among the winners.

Associate Degree

Now, CIE offers an Associate in Applied Science Degree in Electronics Engineering Technology. In fact, all or most of every CIE Career Course is directly creditable towards the Associate Degree.

Today is the day. Send now.

Fill in and return the postage-free card attached. If some other ambitious person has removed it, cut out and mail the coupon. You'll get a FREE school catalog plus complete information on independent home study. For your convenience, we'll try to have a CIE representative contact you to answer any questions you may have.

Mail the card or the coupon or write CIE (mentioning name and date of this magazine) at: 1776 East 17th Street, Cleveland, Ohio 44114.



Pattern shown on oscilloscope screen is simulated.

CIE Cleveland Institute of Electronics, Inc.

1776 East 17th Street, Cleveland, Ohio 44114
Accredited Member National Home Study Council

YES... I want to learn from the specialists in electronics — CIE. Send me my FREE CIE school catalog...including details about the Associate Degree program...plus my FREE package of home study information.

Print Name _____

Address _____ Apt. _____

City _____

State _____ Zip _____

Age _____ Phone (area code) _____

Check box for G.I. Bill bulletin on Educational Benefits: Veteran Active Duty

MAIL TODAY!

RE-20

Good news for you and your customers. NESDA/ISCET rates RCA serviceability:

'Excellent'

"The RCA CTC 108 and CTC 109 chassis have earned the highest possible serviceability rating category...

Excellent...by incorporating serviceability features required in the ISCET Serviceability Rating Form.

"RCA's many years of cooperation with ISCET's Serviceability Committee has helped produce excellent results."

—Dean R. Mock, Chairman, NESDA/ISCET Serviceability Committee

ISCET's 92% (CTC 108) and 93% (CTC 109) ratings were good news to us. Because they mean that some of the most demanding critics in the industry agree that we've succeeded in de-

signing chassis that not only give your customers a first rate picture, but are easy to repair too. Here are some reasons why they think so:

All subassemblies plug into chassis. No tools are needed to remove chassis (main circuit board). Just remove the cabinet back, unplug subassemblies and the chassis is ready for removal.

Roadmapping on both sides of the board.

Although the XL-100 chassis use single-sided circuit boards, double road-mapping means you can easily trace circuits from either side.

Circuits and voltages directly identified. Major circuit areas as well as power supply source and key pulse voltages are labeled by name on the board. So you can find them fast.

That all means that when you do have to repair our new XL-100 chassis, in most cases you can fix them quickly and easily.

And you won't have to waste your valuable time trying to find out where to go to fix what you already know is wrong.

Because to us that's what really counts. Making your job easier and your customers happier.

RCA

RCA IS MAKING TELEVISION BETTER AND BETTER.



For your free subscription to RCA COMMUNICATOR, our magazine of news and advice for service technicians, write: RCA, Dept. 1-455, 600 North Sherman Drive, Indianapolis, IN 46201.

BUILD THIS

THE USE OF DELAY LINES IN AUDIO REPRODUCTION is an increasingly popular way to add a sense of realism to recorded music. By simulating the reverberation characteristics of a large room or hall electronically, and feeding that information to loudspeakers, the sensation of a large listening area is created. State-of-the-art systems using digital storage and microprocessors are capable of producing a complex, realistic simulation of large concert halls in a typical living room. Simpler systems, using either mechanical or electronic (digital or analog) delay schemes can produce a significant improvement in the audible performance of a music system, particularly if they can avoid the artificial quality that is associated with electronic reverberation.

Ideally, it would be desirable to simulate the natural reverberance of a concert hall. When a sound is produced on stage, a small fraction of the sound reaches a listener in the audience directly. This direct (*first arrival*) sound determines the direction and pitch of the source. Shortly thereafter, echos (*reflections*) reach the listener by the shortest path from a wall. More reflec-

*Signetics Corp. Sunnyvale, CA

R-E TESTS IT

LEN FELDMAN

CONTRIBUTING HI-FI EDITOR

THE ANALOG REVERBERATION SYSTEM IS AN audio add-on unit that simulates the ambience and acoustic environment of large listening spaces such as concert halls, night clubs, auditoriums, and even cathedrals. An audio delay is introduced by using charge-coupled devices (CCD's), commonly referred to as bucket-brigade systems, instead of the A/D and D/A converters and digital signal-storage used by some other time delay/reverberation units. In use, program signals are taken from the main stereo system (using a TAPE OUT jack-pair) and connected to the two inputs on the reverberation unit. Some delayed and, if desired, reverberated, signals are fed from the output of the reverberation system to a secondary amplifier and, in turn, to one or more speakers positioned behind or to the sides of the listener. A single speaker, without an amplifier, can also be used.

As is true of all time-delay units of this type, the longer the time delay introduced, the narrower the bandwidth or pass-band of the time-delay system. The time delay available on this reverberation system varied from ap-

Continued

tions occur as the sound bounces off other walls, the ceiling, the floor, and objects in the hall. Because there are, in essence, an infinite number of paths for the reflections to follow, the reverberation is not a series of individual echoes, but a continuous flow of sound. It builds up in a short period of time (typically a few milliseconds) and may take several seconds to die away. The reverberation time of a hall is defined as the time required for the sound level to decrease by 60 dB.

Electronic reverberation

Unfortunately, using either digital or analog delay lines, this sort of reverberation is difficult to simulate. The typical scheme for producing reverberation electronically is shown in Fig. 1. When a signal is applied to the input, it is delayed before it appears at the output. The delayed signal is fed back to the input after being reduced in level, so that it is delayed again. That feedback arrangement allows the reverberation quality to be changed, either by increasing the delay time or by changing the amount of delayed signal fed back to the input.

A system of this type does, however, have several drawbacks. First, the

ANALOG REVERB FOR YOUR HI-FI



CARL SAWTELL*

While nothing may sound quite as good as music performed live in a concert hall, this system will add that "concert hall" feeling to your home sound system.

proximately 5 to 50 milliseconds. Those delay times are illustrated in the oscilloscope traces shown in Figs. 1 and 2. The upper trace in Fig. 1 is a tone burst. That tone burst was used as the input signal to the analog reverb system. With its DELAY control at minimum (fully clockwise) the output signal (the lower trace in Fig. 1) was displaced by approximately 5 milliseconds (the sweep rate is 5 ms per division in both Figs. 1 and 2). Figure 2 shows the maximum time-displacement between the input (upper trace) and output (lower trace)—about 50 milliseconds.

Two frequency-response curves are shown in Fig. 3. The upper curve, which has a rolloff of 3 dB (at the output of the device) at 3.5 kHz, shows the response obtained with the minimum time delay; the lower curve, in which response is already down by some 13.5 dB at the same 3.5 kHz test frequency, shows the response obtained with the DELAY control set to maximum.

While those response curves may appear to be anything but "high fidelity", you must understand that reflected sounds (which the delayed sounds are intended to simulate) also have their high frequencies highly attenuated. Highs are more easily absorbed by walls, floors, ceilings, and other surfaces, while mid-frequencies and lows tend to bounce back with little, or no loss. Thus, the tendency of the analog reverberation system to increasingly attenuate high frequencies as the delay time is increased is desirable, and is not an unwanted side-effect of this, or any other time delay/reverb system.

We measured the total harmonic-distortion of the reverberation system for a mid-frequency (1 kHz) and for a relatively low frequency, with 1 volt applied to the inputs. With delay time set to

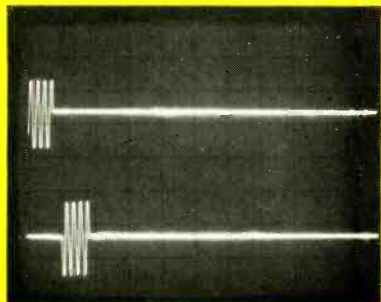

FIG. 1

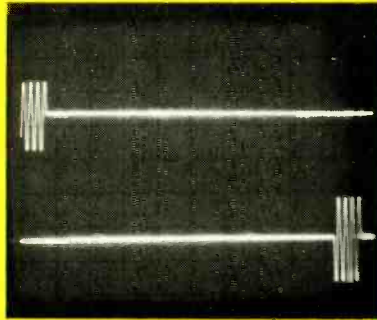

FIG. 2

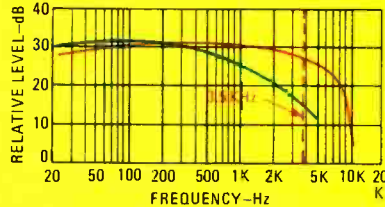

FIG. 3

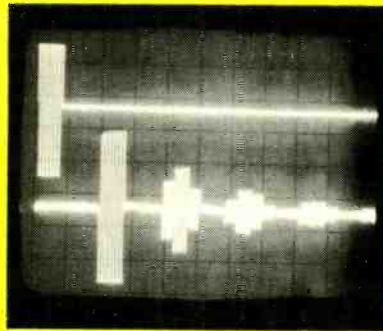

FIG. 4

minimum, the total harmonic distortion was 1.6% at 1.0 kHz and 3.1% at 100 Hz. Turning the delay control to its opposite extreme, we measured a total harmonic distortion of 1.3% at 1 kHz and 1.55% at 100 Hz. Again, while these levels may seem a bit on the high side to audio buffs, it must be remembered that the total contribution of sound energy by the delayed channel is but a fraction of the total sound reaching the listeners' ears. That's because in an ideal setup of this kind, the listener adjusts the rear-channel (delayed) sound so that he or she is not consciously aware that there is a separate source at the rear of the listening room. Thus, if the contribution of the delayed channel is even just 3 dB lower than that of

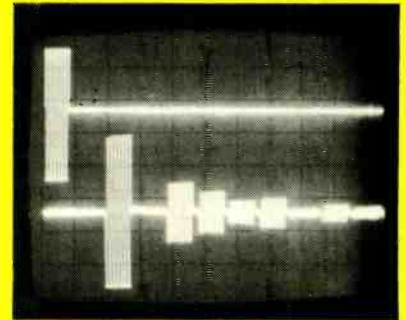

FIG. 5

each of the primary channels, the total harmonic distortion added by the rear channel is only one-third as great as the numbers would imply.

Figure 4 shows what happens when the reverberation control is advanced, while the basic time delay is kept at its minimum and the FEEDBACK DELAY control is set to one extreme. Note the appearance of additional, delayed signals of decreasing intensity. Those extra signals have a decay characteristic similar to what would be found in a large hall with its own natural reverberant decay-time. Additional reverberation effects can be obtained by altering the setting of the FEEDBACK DELAY control, as can be seen in Fig. 5. In that figure the FEEDBACK DELAY control was set to its opposite extreme.

Listening tests

In addition to the measurements and observations just described, we hooked up the analog reverberation system to our own sound system and to an extra amplifier (in the "mono" mode) and pair of speakers. We played a variety of musical material through this system, alternately switching in and switching out the reverberation unit. The unit, once properly adjusted for the type of program material (and that is very important), added a sense of space to our modestly proportioned listening room. We found that the reverberation control should be used in moderation. If used to excess, it gave a false quality—almost a ringing or oscillatory characteristic—to the music. That was not the case with the DELAY control however. When that control was varied, the apparent size of the listening room simply seemed to change.

R-E

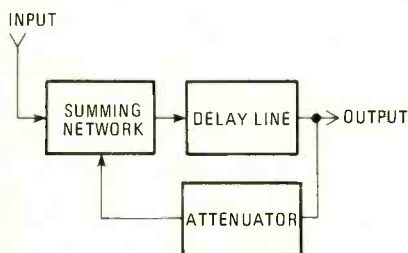

FIG. 1—ELEMENTS OF A REVERBERATION SYSTEM. Part of the output-signal is attenuated and fed back to the input to the delay line to generate a slow decay.

echoes are not random. If the delay time is 10 ms, for example, the second echo appears after 20 ms, the third at 30 ms, and so forth, as shown in Fig. 2. If the delay time is long, those echoes may be heard individually and a "flutter" echo is produced. A natural echo contains many separate random echoes that (in a well designed hall) cannot be heard individually.

A second problem with this simple reverberation system is that it produces a "comb-filter" effect. If we again assume a 10-ms delay, then the input

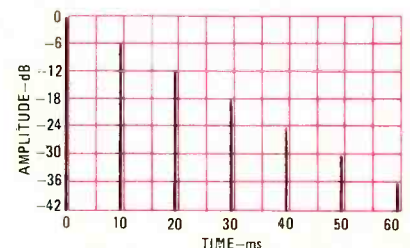

FIG. 2—THE RESPONSE OF A SIMPLE REVERBERATOR to a short pulse. If the delay time is long, the echoes can be heard individually producing a flutter effect.

and the delayed signal are 180 degrees out of phase at 50 Hz. (The period of a 50-Hz signal is 20 ms.) When added together, the sum is the *difference* of the two, and the result is a decrease in output level. At 100 Hz, the input and output are in phase (360-degree phase shift), and add together. Under those conditions, dips in the response would also occur at 150 Hz, 250 Hz, 350 Hz, and so forth. Likewise, peaks in the response would occur at every 100-Hz interval. Figure 3 illustrates that response. Over a 10-kHz range, there would be 100 of those peaks and dips. And as the amount of feedback is increased, the height of the peaks and the depth of the dips also increases.

These problems are actually quite similar to those encountered in a room of poor acoustical design. A large tiled shower is a good example. The hard, reflective walls and the boxiness of the room's shape will create the same sort of flutter echoes. The room's dimensions will also set up "standing waves"

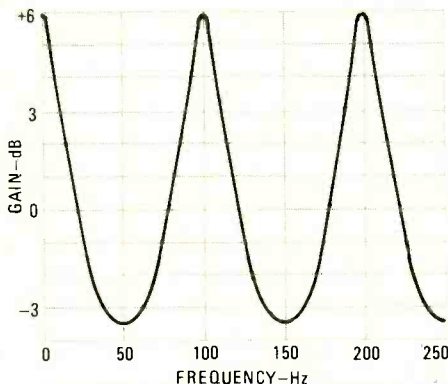

FIG. 3—A COMB-FILTER EFFECT takes place when the input and delayed signals are 180° out of phase, causing a decrease in the overall output level.

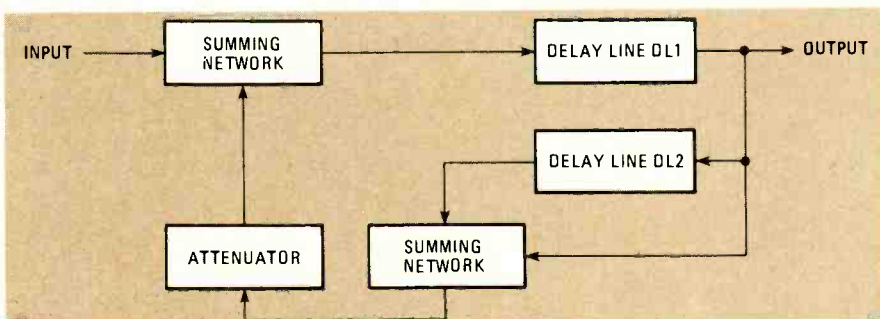

FIG. 4—A MULTIPLE-FEEDBACK SYSTEM uses more than one delay line to break up the pattern of regular echoes.

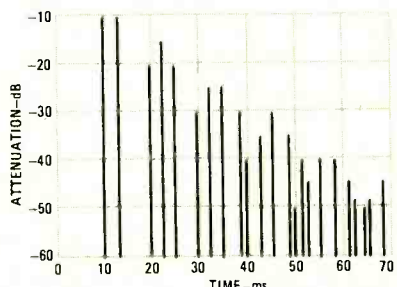

FIG. 5—THE NUMBER OF ECHOES increases with time in a multiple-feedback system, just as it would in an actual concert hall.

that will simulate the "comb-filter" effect described earlier.

Fortunately, the physical solutions to the problem of poor room-acoustics can be carried over into the design of an artificial-reverberation device. Instead of changing the dimensions of the room to give more echoes of different lengths, we can provide delay lines of different lengths in the device. Instead of breaking up the standing waves with objects or acoustical treatment, we can inject delays into the electronic feedback to break up the pattern. A block diagram of the simple system to do that is shown in Fig. 4.

The multiple-feedback reverberation technique is still not a close simulation of actual concert hall reverberation, with its complex combination of delays. This technique does, however elimi-

nate or reduce the most objectionable artificial aspects of electronic reverberation. If delay line DL1 is 10 ms as before, and delay line DL2 is 3 ms, then the resultant echoes will be as shown in Fig. 5. Note that not only do more echoes appear, but that the number of echoes increases with time, just as it would in a natural environment.

The frequency response of a multiple-feedback reverberation device is complex. The peaks and dips remain, but are irregular. The large peaks occur only if the delayed input, the output,

and the delayed output are all in phase, which makes the number of large peaks decrease; however, that situation is unlikely to occur. The number of deep dips in the response tends to be reduced similarly. There are still many ripples present, but they are not deep.

A block diagram of the complete reverberation system is shown in Fig. 6. The stereo signal from a receiver or preamp is converted into a monaural signal by a summing amplifier. The INPUT-LEVEL control allows the signal level to be adjusted for the optimum signal-to-noise ratio. The signal is then filtered through a five-pole "anti-aliasing" filter to minimize intermodulation distortion. *Aliasing* is a phenomenon that occurs in sampling systems. Our delay lines use bucket-brigade IC's. Essentially, those IC's are sampling devices with the sampling rate being determined by the clocking frequency of the IC's. If the input signal being sampled contains components that are higher in frequency than can be handled by the sampling rate, aliasing occurs. Then, the high-frequency components are "read" as low-frequency components and appear at the output of the sampling device along with the low-frequency components of the input signal. The low-frequency components mix together and intermodulation distortion results. To prevent aliasing from occurring, the input signal is filtered before it reaches the sampling device by either a low pass or bandpass filter to eliminate the signal components that are too high in frequency for the sampling rate to handle. A filter of that sort is commonly referred to as an *anti-aliasing filter*.

The main delay line in Fig. 6 is DL1. Its output is filtered by a seven-pole active filter to eliminate switching waveforms, ultrasonic signals, and to reduce the likelihood of creating beat frequencies from the high-frequency signals present in the system. The de-

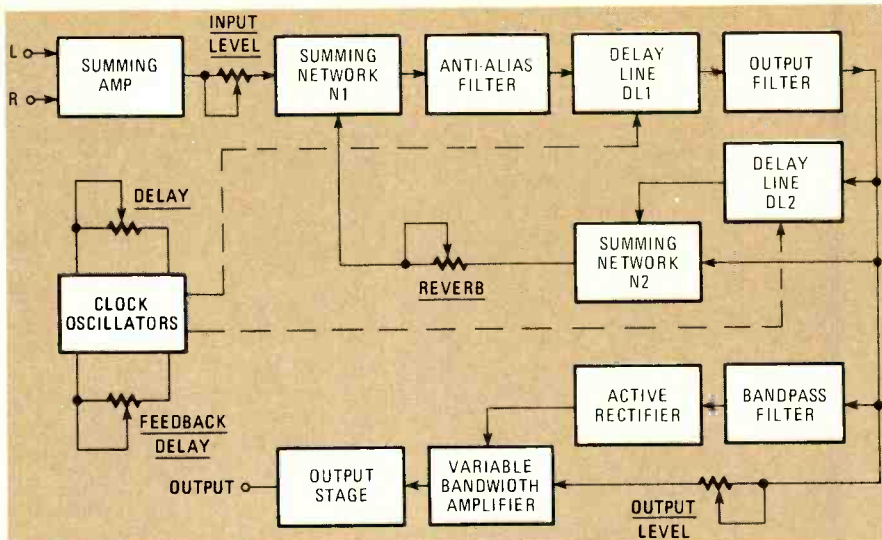

FIG. 6—THE SIGNAL-PROCESSING PATH of the analog reverberation system shows how the original signal is recirculated at ever-decreasing levels.

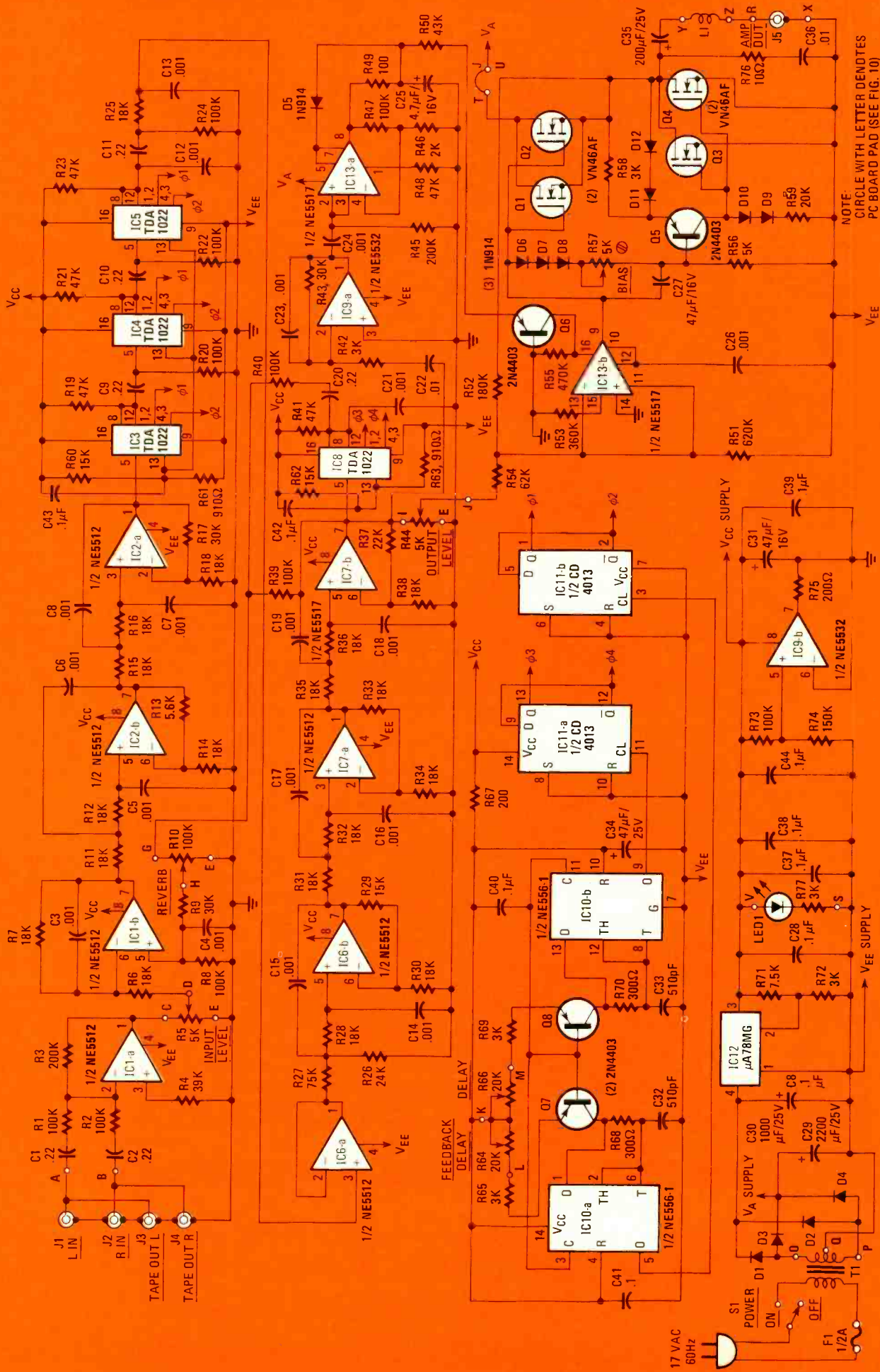

FIG. 7—SCHEMATIC DIAGRAM of the analog reverberation system. The delay required by the system is provided by IC3, IC4, IC5, and IC8—four "bucket-brigade" IC's (how they work is discussed in the text).

DIGITAL DELAY VS. BUCKET BRIGADES

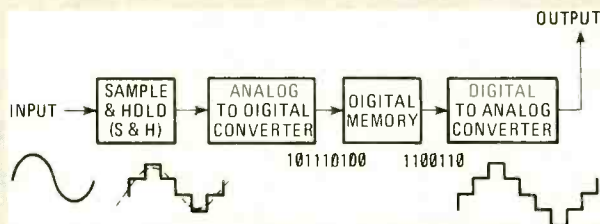

FIG. 1

TWO ELECTRONIC APPROACHES ARE CURRENTLY used to delay analog signals. The one that has received the most attention lately is digital delay, shown in Fig. 1. In that system, the signal is measured at regular intervals (*sampled*) and the sampled voltage is converted to a number (*quantized*). The sampling operation is done by a sample-and-hold circuit that uses a capacitor to store a voltage representing the instantaneous signal-level. The voltage stored by the capacitor is temporarily held off the input, making it possible for an analog-to-digital converter to derive a digital value for it. (Not all A/D converters require sample-and-hold circuits, but those commonly used for

audio produce significant errors if the input voltage changes during the conversion process.) A number representing the signal can be stored in digital memory and, after the desired delay-time, be reconverted to an analog voltage. The output of the D/A converter may also contain a sample-and-hold circuit to store the output voltage during the next conversion.

The second method is the bucket-brigade delay line (BBD), a single-IC delay system that is, in effect, an analog shift register (see Fig. 2). Like the digital delay-line, the bucket brigade is a sampled system, but no digitizing is involved. Manufactured as a long string of MOSFET switches and

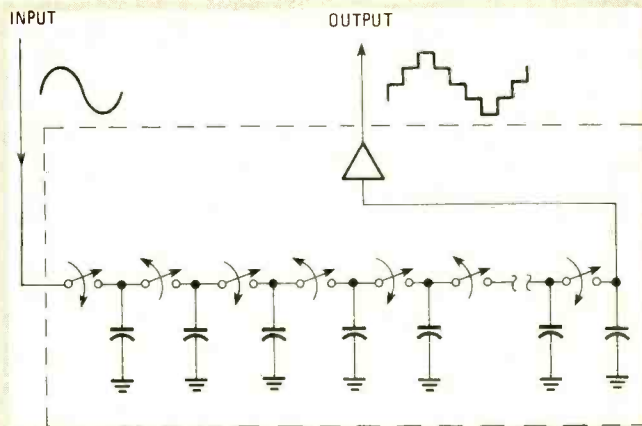

FIG. 2

capacitors, the BBD acts like a long string of sample-and-hold devices. At the beginning of a clock cycle, the input signal is stored by the first capacitor. During the second half of the clock cycle, that voltage is transferred to a second capacitor, and the input capacitor is ready to store a new voltage. During the next clock cycle, the original input signal is transferred from the second to the fourth capacitor, and so on. After 256 clock pulses, the original input-voltage appears at the 512th storage capacitor, which is the output of the TDA1022. The length of time it takes to transfer a signal (the delay) depends on the frequency of the clock used. **R-E**

delayed signal is fed back to the input of the anti-aliasing filter through summing network N2. It is also fed to a second delay line to provide the second feedback path. The level of the delayed signals is controlled by an attenuator (REVERB control) and then combined with the input signal by summing network N1.

The output-filter signal, which consists of the input-filter signal plus all of the delayed signals, is first attenuated by the OUTPUT-LEVEL control and then fed to a variable-bandwidth filter. The control signal for this filter is derived by a bandpass filter and active rectifier. Those three blocks make up a noise-reduction circuit that minimizes the level of audible hiss in the output signal.

The final block in the signal-processing chain is an amplifier. This amplifier provides an output of approximately one watt to an 8-ohm speaker. The amplifier is also quite capable of driving a 4-ohm speaker. Although this output is minute when compared to that of the main amplifier in a hi-fi system, it is more than adequate when the reverberation system is properly set up.

In practice, the output from the reverberation unit drives a third speaker at the rear of the listening room. The output-level control is adjusted so that the listener is not consciously aware of the third speaker. In fact, the third speaker should be barely audible over the two main speakers.

How the circuit works

Figure 7 shows a complete schematic of the reverberation system. The input is taken from the tape-monitor outputs of your hi-fi system. Because the input signal will typically come from the tape output of a preamp or receiver, the inclusion of a second set of jacks (J3 and J4) allows for the connection of a tape deck. The input impedance of the reverberation unit is 100 kilohms and it should not load down your hi-fi's tape-monitor circuit significantly.

Capacitors C1 and C2 couple the input signal into summing amplifier IC1-a. The gain of this stage is 6 dB and can be modified by changing the value of R3. You may want to alter the gain if the unit is to be used in applications with particularly low-level signals, such as those from a microphone or electric guitar, or with high-level ones like the output of a power amplifier. Since the INPUT-LEVEL control, R5, follows this first stage of amplification, it is important that the signal applied to it not be too large, or overload will result. (As designed, the inputs will safely handle a 2-volt input level, more than sufficient for line-level inputs from a receiver.)

Op-amp IC1-b serves two purposes. First, it provides unity-gain inversion of the signal from the input-level control with capacitor C3 limiting the bandwidth of the signal to 9 kHz. Its second purpose is to sum the input signal with the delayed (feedback) signal. The level

of this feedback signal is controlled by the REVERB control, R10. The R-C network connecting R10 to the positive input of IC1-b serves to reduce the feedback at high frequencies. This simulates the natural tendency for acoustically-reflective materials to absorb high-frequency sound, giving more reverberation at low frequencies.

Op-amps IC2-a and IC2-b form an active low-pass filter with a cutoff frequency of 9 kHz. Together with the filtering action of summing amplifier IC1-b, they form a five-pole anti-aliasing filter that rolls off the input signal at a rate of 30-dB per octave. This filter reduces noise and distortion in the system by reducing the potential for intermodulation distortion (aliasing) in the delay lines. The slew rate of the input signal is also reduced by this filter. Too high a slew rate causes distortion in the op-amps. (This is not to imply that this would be a significant problem. The NE5512 op-amp specified can produce full output at 20 kHz without reaching its slew-rate limit.)

Philips TDA1022 bucket-brigade delay IC's are used for the main delay line. These are called out as IC3, IC4, and IC5 in Fig. 7. Although identical to other commercially available bucket-brigade IC's in most respects, the TDA1022 is unusual in that it uses p-channel MOSFET's. The three delay-IC's are driven by a common clock and are cascaded to give three times the de-

lay of a single IC. Capacitive coupling between stages minimizes the effects of DC offsets in the delay line.

The output of the third bucket-brigade device, IC5, is filtered by another 9-kHz R-C filter and fed into op-amp IC6-a, which is connected as a voltage follower. This is followed by three more active-filter stages consisting of IC6-b, IC7-a, and IC7-b. This active filter provides a 36-dB-per-octave rolloff above 9 kHz and is designed so that the complete system—including the input and output filters—has a flat response below the cutoff frequency. This means that neither the input filter nor the output filter has a flat response, but the minor ripples in the responses tend to cancel and give a flat frequency-response below 9 kHz followed by a 72-dB-per-octave rolloff.

The output of the filter is fed to a fourth bucket-brigade device, IC8, which was shown as DL2 in Fig. 6. Both the filter-output and the output of IC8 are fed to the REVERB control and combined with the input signal by sum-

ming amplifier IC1-b. The output of the filter is also fed to the OUTPUT LEVEL control, which is the primary volume control for the system.

The signal from the OUTPUT LEVEL control is fed to IC13-b. Two major functions are provided by op-amp IC13-b. First, it supplies drive for the output-amplifier stages. Although certainly not a high-power amplifier, its output is adequate for most purposes, and it eliminates the expense of having to add a power amplifier to the system. This IC also acts as the variable-bandwidth filter in a noise-reduction circuit. By making the bandwidth vary as a function of the signal level, the noise in the output signal is reduced.

A transconductance amplifier, the NE5517, was selected for IC13. This IC contains two independent transconductance-amplifiers in one package. By varying the current applied to pins 1 and 16, the gains of the two sections can be controlled independently.

To minimize audible side-effects of the noise-reduction circuit, the band-

width of IC13-b is made a function of the high-frequency content of the input signal. The high-frequency content is sensed by a bandpass filter composed of IC9-a and its feedback network. The input to this filter is taken from a point ahead of the OUTPUT LEVEL control so that it is not dependent on the volume setting. The output from IC9-a feeds IC13-a, which is configured to operate as an active rectifier. The gain of IC13-a is set to 51 by bias resistor R48. After the signal is rectified by IC13-a, a DC potential exists on C25 that is a measure of the high-frequency level, and determines the bandwidth of the dynamic filter.

The variable-bandwidth output filter works by varying the gain of IC13-b. Compensation for the amplifier is provided by capacitor C26, which sets the gain-bandwidth product. If the gain of the amplifier is varied by changing the bias current applied to pin 16, the bandwidth is also varied. To accomplish this, the control voltage from C25 is fed to pin 16 of IC13-b through a network consisting of R50, R55, and Q6 which develops a current proportional to the rectifier output. This causes the bandwidth of the amplifier to be proportional to the high-frequency level detected by the rectifier circuit.

The power amplifier's output stage uses four VMOS power transistors (Q1-Q4) in a push-pull configuration. Transistors Q1 and Q2 act as a source follower to drive the load directly. Transistors Q3 and Q4 are driven by Q5, a small-signal PNP-type, which senses the gate drive-voltage on Q1 and Q2 through diode-string D6-D8. When the gate drive-voltage is low (Q1 and Q2 beginning to turn off), Q5 provides drive for the gates of Q3 and Q4, which supply drive current for the negative portion of the cycle. Although Q1 and Q2 will turn off completely on large negative swings with a low-impedance (speaker) load, for most purposes the amplifier operates class A. The operating current is set by trim pot R57. In the case of high current-loads, D11 and D12 prevent the gates of Q1 and Q2 from being pulled negative with respect to the source, an undesirable condition for the VMOS transistor.

The amplifier is coupled to the speaker through capacitor C25. The R-L-C network at the amplifier's output decouples the loudspeaker from the feedback loop to improve stability. Although this amplifier has a limited power-output (due primarily to power-supply limitations), it can safely be used with 4-ohm loads. Transistors Q1 and Q2, and Q3 and Q4, are connected in parallel for this purpose. No current-hogging or thermal instability results from connecting VMOS devices in parallel (as

continued on page 104

PARTS LIST

Resistors ¼ watt, 5%, unless otherwise noted

R1, R2, R8, R20, R22, R24, R39, R40, R47, R73, R74—100,000 ohms
R3, R45—200,000 ohms
R4—39,000 ohms
R5, R44—5000 ohms, potentiometer, audio taper
R6, R7, R11, R12, R14-R16, R18, R25, R31-R36, R38—18,000 ohms
R9, R17, R30, R43—30,000 ohms
R10—100,000 ohms, potentiometer, linear taper
R13—5600 ohms
R19, R21, R23, R41, R48—47,000 ohms
R26—24,000 ohms
R27—75,000 ohms
R28—27,000 ohms
R29, R60, R62—15,000 ohms
R37—22,000 ohms
R42, R58, R65, R69, R72, R77—3000 ohms
R46—2000 ohms
R49—100 ohms
R50—43,000 ohms
R51—620,000 ohms
R52—180,000 ohms
R53—360,000 ohms
R54—62,000 ohms
R55—470,000 ohms
R56—5000 ohms
R57—5000 ohms, trimmer potentiometer
R59—20,000 ohms
R61, R63—910 ohms
R64, R66—20,000 ohms, potentiometer, linear taper
R67, R75—200 ohms
R68, R70—300 ohms
R71—7500 ohms
R76—10 ohms

Capacitors

C1, C2, C9-C11, C20—.22 μ F, 100 VDC, Mylar
C3-C8, C12-C19, C21, C23, C24, C26—.001 μ F, polystyrene

C22—.01 μ F, polystyrene
C25, C27, C31, C34—4.7 μ F, 16 VDC, electrolytic
C28, C37-C44—.1 μ F, ceramic disc
C29, C35—2,200 μ F, 25 VDC, electrolytic

C30—1000 μ F, 25 VDC, electrolytic
C32, C33—510 pF, ceramic disc
C36—.01 μ F, 400 VDC, electrolytic

Semiconductors

D1-D4—1N4002, 100 PIV, 1 amp
D5-D12—1N914
LED1—jumbo red LED
Q1-Q4—VN46QF VMOS transistor (Siliconix)
Q5-Q8—2N4403 PNP transistor
IC1, IC2, IC6, IC7—NE5512 low-noise dual op-amp (Signetics)
IC3-IC5, IC8—TDA1022, 512-stage bucket-brigade device (Philips)
IC9—NE5532 low-noise dual op-amp (Signetics)
IC10—NE556-1 dual timer (Signetics)
IC11—CD4013 dual D flip-flop (RCA)
IC12— μ A78MG adjustable voltage regulator (Fairchild)
IC13—NE5517 TCA (Signetics)
L1—10 turns of No. 22 wire wound around C35
T1—36 VCT, 300 mA

Miscellaneous: PC board (double-sided with plated-through holes), case, hardware, etc.

NOTE: The following are available from Advanced Analog Systems, Inc., 790 Lucerne Dr., Sunnyvale, CA 94086 (Tel. 408-730-9786): ARS-911—complete kit including case, \$149.95; PC-911—PC board only, \$24.00; IC-911—IC1-IC13 and Q1-Q8 only \$49.95. Visa and Mastercard welcome. California residents please add sales tax. Prices include shipping (within continental U.S. only).

Home Electronics

WHAT THE FUTURE WILL BRING

LEN FELDMAN
CONTRIBUTING EDITOR

We're always interested in knowing what the future holds. The most recent Consumer Electronics Show gave us a look at that future—as it exists today.

THE FOUNDER OF THIS MAGAZINE, HUGO Gernsback, was one of the true prophets of the electronics industry of his time. Many readers of **Radio-Electronics** will recall issues of this magazine which were devoted to predictions, by Hugo Gernsback, of "electronics miracles" still to come. Amazingly, many of his predictions that might then have seemed far-fetched have indeed come true and exist today in the form of readily available consumer electronic products.

At the most recent Consumer Electronics Show in Chicago, held in early summer, 1981, one of the largest electronics manufacturing and research companies in Japan—Matsushita Electric Industrial Co.—exhibited more than 190 electronics products in a 12,000-square-foot exhibition that was in much the same tradition as the prophetic early editions of **Radio-Electronics** but with one major difference: All of the products were in the form of working models, with many of them already scheduled for early production and distribution throughout the world. Of particular interest to readers of **Radio-Electronics** were the latest in video and audio products, communication equipment, and component technology. Matsushita's exhibit also included products for the business and industrial fields as well as medical-electronics products.

We can only highlight a few of the items we saw, but from our description of these innovative products, you should get some idea of the diversity of the exhibit and of what the electronics-based home of the future is likely to contain.

High-definition color TV

It has been said that the U.S. pays the penalty for "being first" by ending up with inferior-technology systems,



while countries that are content to wait benefit from our early mistakes. Nowhere is that more true than in the case of TV standards and, in particular, those for color TV.

Many experts feel that the PAL and SECAM systems used in other parts of the world deliver better pictures than does our NTSC system, (which is also used in Japan). Bypassing all three of those systems, Matsushita (whose trade names Panasonic, Technics, and Quasar are probably more familiar to American consumers than is the more-difficult-to-pronounce name of the parent company) has developed, and showed, an SHF (Super High Frequency) DBS (Direct Broadcasting Satellite) system combined with a high-definition, wide-screen, TV camera and receiver. The elements of the entire system are shown in Fig. 1. The SHF satellite-TV system is considered by many to be one of the most promising new concepts in broadcasting because of its ability to improve poor reception in remote areas and to eliminate the problem of "ghosts" in other problem-reception areas such as densely populated cities. The SHF band extends from 3 GHz to 30 GHz and the current lack of crowding in that band would permit the establishment of channel bandwidths that are wide enough to support the high-definition standards which Matsushita—along with others, such as CBS in this country—has proposed.

The high-definition TV system would produce better images than those obtained with 35 mm film, using 1125 scanning lines as opposed to the existing NTSC system which uses only 525 scanning lines. Among the newly developed elements and components that make the system practical are a low-noise SHF/RF converter, an easy-to-install dish antenna, an 1125-line high-resolution color picture tube, a high-resolution color TV camera with a 30-MHz-bandwidth amplifier and edge-enhancer, and a high-definition TV-signal transmission system using fiber optics technology.

3-D television

One of the most frequently made predictions about electronic products of the future has concerned three-dimensional television. Some have even imagined a holographic display-system to create what appear to be live, moving, three-dimensional images in your living room. At the Matsushita exhibition, a much more straightforward approach was used; one which, in fact, can be used with existing VCR's and conventional TV sets or monitors. It is expected to find wide application in the field of entertainment, education, and training and industrial applications, including computer displays.

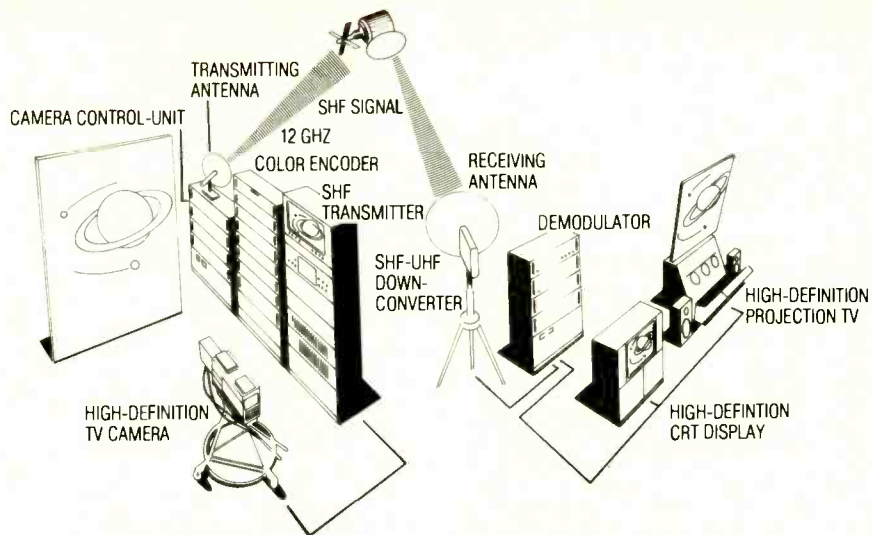

FIG. 1—THE SHF DBS SYSTEM, combined with high-definition equipment can offer high-quality video with more than twice the resolution and clarity of existing systems.



FIG. 2—TWO VIDEO CAMERAS, one for the right-eye image, and one for the left-eye image, are required for 3-D television.

The 3-D system consists of a specially designed camera, signal-processing circuitry and eye glasses with electronic lens-shutters. The 3-D TV camera (see Fig. 2) consists of two video cameras, positioned slightly apart, but focusing on the same image—working in much the same way as a pair of human eyes. The video signals from the right and left camera are fed *alternately* to the TV set or video recorder, a field at a time. The alternating fields are viewed through special glasses equipped with operated shutters synchronized with the changing left-eye and right-eye images. The mind combines the two images and the viewer sees a three dimensional one.

A videodisc with record capability

Business journals and the general press have been reporting of late that the sales of videodisc players are not meeting the original expectations of their manufacturers. One reason given for that is the notion held by uninitiated shoppers that videodisc machines can record as well as play back. Once they learn that this is not the case, prospective customers frequently opt for a videotape recorder instead. That may soon change.

One of the products at the Matsushita exhibit was a compact disc-type still-

video (single-frame) record/playback system. Using semiconductor-laser technology, the unit can record 15,000 individual frames of information on a 200 mm disc with access to any given frame in 0.5 second. The new system uses a single semiconductor-laser as an optical source and a disc with 15,000 concentric grooves coated by a thin film of highly sensitive recording material. The disc is made of a plastic substrate on which a recording layer of sensitive tellurium suboxide film is coated. The recording layer is a vapor deposit of 15,000 concentric grooves of 2.5 micron pitch. Each groove is 0.8 micron wide and contains an address signal that guides the laser beam for stable recording and playback. While the new material is sensitive enough to permit the use of a semiconductor laser, it also resists temperature and humidity variations. Unlike conventional optical-disc recording systems, the laser does not make any holes on the disc surface. Rather, the recording is made by changing the optical characteristics of the disc.

The video signals are modulated by varying the intensity of the laser beam. The optical recording material on the disc absorbs the laser-beam energy and its optical characteristics are changed by the heat. The irradiated regions have different reflectivity compared with that of the non-laser-irradiated regions. The signal for a single still picture is recorded in a single groove on the disc. During playback, the laser beam, this time using less power than during recording, is reflected from the disc and reconverted into the original video signal.

To retrieve a single picture, a linear motor drives an optical head for a rough search, and then the head pinpoints the desired single frame using an electronic tracking-system. Both mechanisms are controlled by a microcom-

puter that permits fast image retrieval within 0.5 seconds. Some 95 patents are being applied for in Japan for this new device, with 9 more patents being applied for elsewhere.

High-speed videotape duplicator

The relatively high cost of pre-recorded videotapes is caused at least in part by the fact that duplication of tapes is a real-time process. A two-hour movie master-tape takes two hours to copy and, while many "slave" copiers can be fed from a single master-tape player, the process is still quite time-consuming and expensive. Now, the high-speed videotape printer shown in Fig. 3 can duplicate two or four-hour VHS video cassettes in less than four minutes. The printer is fully automatic and features a built-in 15-cassette feeding system for continuous, unattended tape duplication.

The tape-duplicating system consists of a master-tape recorder and a separate high-speed printer. The master-tape recorder records mirror-image signal patterns on a master tape in the usual real-time. The master tape is then transferred to the printer, which produces copies at high speed by transferring the signal patterns from the master tape onto the blank "slave" tape. The recording unit uses a direct-drive cylinder and capstan for highest possible tape-motion accuracy.

The duplication method is known as "video anhysteretic-transfer contact-printing by bifilar tape-winding." In it, the specially formulated, and very-highly-magnetized, master tape is brought into contact with the blank "slave" tape, both of which are moving at extremely high speed. The master actually imprints an image of itself on the "slave" by magnetizing it directly with the video and control signals. The audio information is transferred by a recording head when the tape is re-wound after the video and control signals have been imprinted. The system promises to lower the cost of pre-recorded VCR tapes in the future, and just what effect that will have on public acceptance of video *disc* formats (one of whose chief arguments has been the lower cost of software) is difficult to predict.

Micro video systems

Nearly a year ago, Sony Corporation demonstrated a mini-sized color video camera that incorporated a tape-transport and all the electronics needed for a single-piece, lightweight home videotaping system. At that time, officials of the corporation estimated that the new videotaping format would not be available before 1985. In typical one-upmanship not uncharacteristic of Japanese electronic firms, a combination color

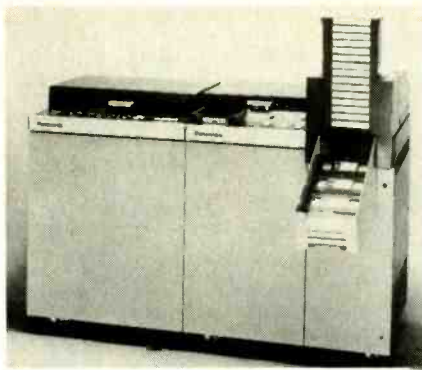

FIG. 3—THIS HIGH-SPEED videotape printer can duplicate a two or four-hour VHS video cassette in less than four minutes.



FIG. 4—INTEGRATED CAMERA/VCR unit weighs just 4.2 pounds. The cassette is about the same size as a standard audio cassette.

video-camera/recorder claimed to be the smallest, lightest, and lowest in power consumption of "any previously proposed format" was demonstrated at the Matsushita exhibit.

The system, shown in Fig. 4, uses a solid state micro-video system in which the camera portion uses a newly developed single-chip CPD (Charge Priming Device) image sensor which is said to combine features of both MOS and CCD image sensors; namely wide dynamic range and low noise. Maximum recording time would be two hours using a new high-density "metal evaporated" magnetic tape that is just 7 mm wide and is housed in a cassette package that is a bit smaller than an ordinary audio cassette. The unit is extremely compact, measuring 7.8 by 4.7 by 2.6-inches and weighs only 4.2 pounds. Power consumption is just 4.2 watts.

This system, obviously a step ahead of the Technicolor videotape format that has been marketed for more than a year, brings to at least six the number of home videotape formats that are likely to coexist in the near future (Beta, VHS, Philips, Technicolor, Sony's future all-in-one, and now, Matsushita's single-piece camera/tape-mechanism entry). Whether all of them can survive is highly questionable, though at present both Beta and VHS seem to be having no difficulty in the marketplace and we are told that Sony, for one, is having a

tough time turning out enough Betamax machines to meet worldwide demand, even though the Beta format is outsold by first-place VHS machines by about seven-to-three!

How would I look as a blonde?

...Or with a moustache, or beard, or wearing horn-rimmed glasses, or with a radically different hair style or...yes... even with a hairpiece? If you have ever wondered about those or other matters of style and appearance, imagine being able to walk into a store, standing in front of a video camera and watching yourself being transformed by a new hairstyle, a pair of glasses, or other cosmetic changes.

Actually, Matsushita's new "Style-setter" TV system, far from being an item in our future, is already in use in beauty parlors in Japan. The system works by taking a video picture of the customer, freezing the image on a TV monitor, and then superimposing various hair styles, glasses, etc. over the stationary image. The unit consists of a compact video camera, a magnetic-sheet-memory recorder, and a video image-synthesizer—the unit that superimposes the changes over the original image. The image recorded on the sheet-memory recorder does not have to match a predetermined posture since the synthesizer adjusts superimposed images to the recorded image by means of a joystick-type control. The size and shape, and even the color, of the changes can be adjusted to fit the contours of the subject's face.

Another use for the synthesizer has been to provide police departments with a more accurate means for creating identification pictures of crime suspects. Police artists can modify standard identification-kit models to fit witnesses' descriptions and create highly accurate likenesses of suspects.

Largest projection-TV yet

Projection-TV screens have been growing steadily larger as better and brighter high-intensity CRT's are developed, but unless you attend the Summer '81 CES and the Matsushita "show-within-the-show" you've probably never seen anything as large as their new high-brightness picture projected on an 11¼ by 8½-foot screen. The system, designed for institutional use, can be adapted for either front or rear projection and includes a projector featuring a new 13-inch cathode-ray tube. The system provides superb resolution as well as a light output of 300 lumens. The unit is contained in a floor or ceiling-mountable box measuring about 42 inches wide by 34 inches deep by 23 inches high and weighing 230 pounds. Depending upon the image-size desired, projection distance can be as little as 3.8 yards (2.7 yards behind the screen if

a mirror is used) or as much as 5.4 yards.

Three 13-inch monochromatic CRT's (red, green and blue) combine a newly introduced bipotential-field electron gun with a large main-focus lens, and a decelerating-potential-field-type pre-focusing lens. The system projects its images through a magnifying lens onto a flat plastic screen.

In tests, the system has been used at hotels and in school auditoriums, with a viewing angle as wide as that for normal motion-picture viewing. Some uses envisioned for the system include projection of surgical operations for medical classes, display of real-time data to business or government executives, and presentation of special events to large audiences. The company has indicated that it plans to introduce the system commercially into the United States by late 1982.

The ultimate sketch pad

Remember the little slate with the lift-up plastic sheet that we all played with and drew on when we were kids? I was reminded of that toy when I saw Matsushita's *Compu-Cassette* audio/



FIG. 5—COMPUTER-GENERATED GRAPHICS can be combined with single video frames on this terminal. An ordinary cassette tape is used to store the finished color images along with a sound track.

visual communication system which uses conventional stereo audio-cassette tapes for recording sound and digitally processed graphic information.

Video information is recorded digitally on the right channel while analog audio information is recorded on the left channel. A one-hour cassette tape can store approximately 200 pictures with sound. The system includes a video signal-processor, stereo cassette-deck,

light pen and color monitor, with a keyboard, remote control, and printer as options. The video signal processor, shown in Fig. 5, includes a controller, memory, interfaces, and a video-display generator. Figures and illustrations are shot sequentially by a monochrome camera with three color-filters. The video-image data is converted to digital form and stored on a floppy disk for editing and arranging. The system is also capable of generating eight-color graphics displays.

With the development of the appropriate software it should find application as an information center, learning aid, home amusement-center, or even as an electronic magazine or textbook.

While the products in Matsushita's "Technology Today" exhibit that we have discussed were largely in the video and TV fields, you should know that there were equally impressive products in such categories as audio, business products, home appliances (even a microwave oven that talks to its user), component technology, medicine, and manufacturing. Many of the products of the future already exist in today's technology. **R-E**

What's News

Sears catalog on videodisc

The Sears Summer 1981 catalog has been put on videodisc for viewing in selected Sears stores and catalog-sales offices in the Washington, DC and Cincinnati areas, as well as in about 1,000 homes that have compatible videodisc players hooked to their TV sets.



SEARS SUMMER '81 CATALOG, electronic style. It supplies all the information of the printed catalog—plus the added excitement of motion and sound.

The experiment is an early part of a study of electronic technology in catalog selling. The viewer has the ordinary catalog display, plus action and sound. Shopping electronically is like playing a TV game. The viewer is given an index, and can select the desired departments

or items by pushbutton. Most of the merchandise sections begin with a series of "browsing" frames that quickly show all the products offered in a given line. The viewer can scan the assortment in seconds, then reverse for a closer look at any item.

Ordering is the same as ordering from a catalog. The viewer takes down the ordering information displayed on the screen and the videodisc catalog number, then phones it in or takes it to the catalog-order desk.

Universal external interface of DiscoVision players

SSM Microcomputer Products has developed a microprocessor interface to read-only video discs, which, with appropriate supporting equipment, can give the user possession of a vast library of information. This Universal External Interface (UEI) is being made exclusively for DiscoVision Associates, a joint project of IBM and MCA. DiscoVision markets laser-based videodisc playback units.

In its "constant angular velocity" mode, the DiscoVision player, has 54,000 tracks, with one complete video frame stored per track. The theoretical digital data storage capacity is 50,000 megabytes per side. That means that each side of a disc could hold the equivalent of about 180 300-page books. When the player's "constant linear velocity" mode is used, the capacity is nearly double.

A typical setup would include the Universal External Interface, a microcomputer complete with keyboard and video terminal, the DiscoVision player, and a TV monitor. That setup could offer facilities

equal to those that would be found in an immense library, accessible within seconds by microcomputer control. For example, a doctor could refer immediately to an amount of information equal to that in the finest medical library. A student could have all of the text and reference works that he or she could possibly require for eight years of undergraduate and graduate studies on a single disc. The videodisc, tied to a personal computer, could be a significant competitor to the broadcast and wired network services in the distribution of inexpensive mass information. It could also be the ultimate system for computer-assisted instruction and reference, since sound, video, and digital data can be mixed on a single disc.

Computer-originated mail system

RCA's Government Communications Systems unit has been awarded a contract by the U.S. Postal Service to develop and install an electronic computer-originated mail system (E-COM).

The system will offer mailers high-speed delivery of notices, statements, and other computer-originated items. Computer-generated messages will be transmitted from the mailers by domestic common carriers to some 25 serving post offices around the nation. The system, scheduled to be in operation by early next year, will deliver a message anywhere in the continental United States within two days of its transmission to the appropriate E-COM serving post office.

RCA will install equipment, develop computer programs, train postal employees, and provide initial maintenance. Cost of the contract is being negotiated. **R-E**

COMMUNICATIONS

All About SCANNERS

Have you ever wondered what makes scanning receivers so popular? Sophisticated electronics and, perhaps more important, exciting listening are two good reasons.

ROBERT B. GROVE

IN THE MID 1960'S, TUNEABLE AND CRYSTAL VHF receivers were quite common. Some general-coverage shortwave receivers covered the lower portion of the VHF band as well. But in 1968, the picture changed. An engineer named Al Lovell had an idea: What if a series of separate crystals could be switched automatically allowing the receiver to look for active channels? That idea led to the creation of the scanning receiver.

The first scanners

The basic scanner patents were assigned to Lovell's new company, Bearcat. Electra, Bearcat's parent company, is understandably proud of the role it has played in the industry since those early days.

But its scanners are not the only products on the market. Many early entries, from such firms as Tennelec, JIL, SBE, and others have come and gone. Today, Regency and Radio Shack are the two major contenders in the race with Electra for scanner sales. As we went to press, another company, ComRadar Corporation, announced its entry into the scanner market. All four companies offer quality products.

How scanners work

Early crystal-controlled scanners were relatively simple. Since their frequency ranges were limited, the factory or the user merely peaked the receiver's performance near the center of the range to be monitored. Naturally, the receiver's sensitivity dropped off slightly at the edges of those ranges, but the units were still quite acceptable for local listening.

The same technology is still used in low-cost crystal scanners (see Fig. 1).

The first frequency-synthesized scanner was developed by the Teaberry Company. Its scanner, originally scheduled for introduction in 1972, never was released because of numerous problems with the device. In the Teaberry scheme, a single crystal-controlled master oscillator was used

for all allowable frequencies. That master oscillator was a combination of frequency dividers, mixers, and multipliers (see Fig. 2). That is the same technique that is used today. The master oscillator can generate an almost infinite number of frequencies, each spaced to match the in-

cremental frequency assignments throughout the VHF/UHF spectrum. In today's scanners the actual frequency generated at any instant is determined by a microprocessor.

But the microprocessor does more than determine the listening frequency; it also peaks the RF stages of the scanner automatically so that it will be properly tuned no matter where the receiver is listening. In the Bearcat *Track Tuning* scheme, the peaking is done by voltage-variable capacitors, also known as varactors (see Fig. 3). The capacitance of a variable-voltage capacitor is controlled by the voltage across it. To change the capacitance in the tuned circuit, a microprocessor regulates the voltage across the variable-voltage capacitor, peaking the tuned circuit that the capacitor is in.

Three years after the Teaberry scanner was to have been introduced another manufacturer, Tennelec, actually released a programmable synthesized scanner. The *MemoryScan* was a premature product, and did not last long. Neither did the scanner entries from SBE/Linear Systems (*Optiscan*) or JIL (*model*

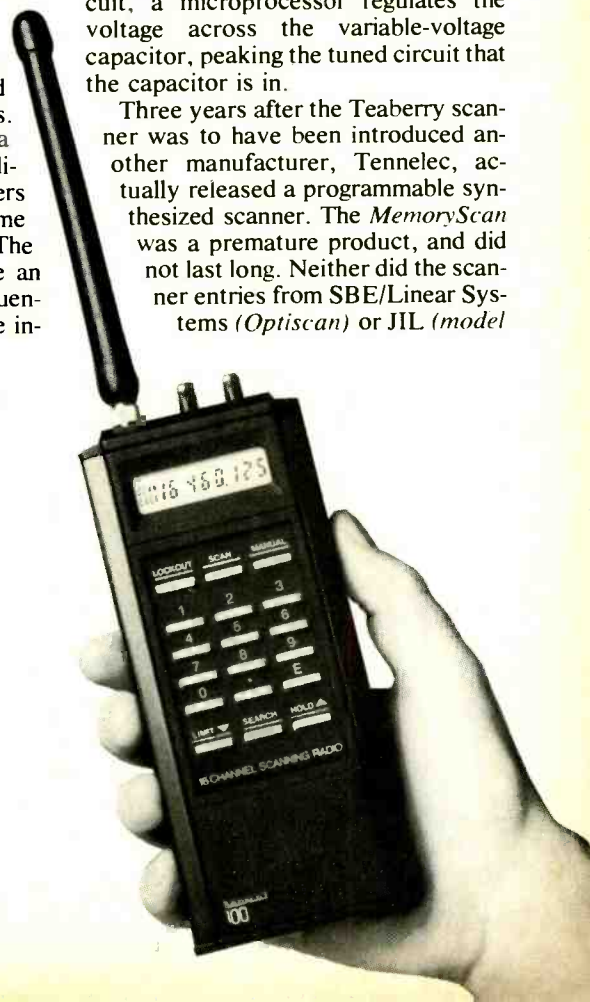

FREQUENCY LISTS AND SCANNER CLUBS

Owning a scanner is the first step. Knowing where to listen is the next. Hobby-radio stores are excellent sources for local frequency lists. For more extensive listings, several excellent publications are available.

For hobbyists who enjoy listening primarily to public safety communications, Gene Hughes' *Police Call Radio Directory* is hard to beat. It is regionalized by state and costs \$5.95 from Radio Shack, or is available directly from the publisher, Hollins Radio Data, P.O. Box 35002, Los Angeles, CA 90035.

Handler Enterprises offers the *Radio Communications Guide*, concentrating on shortwave frequencies but featuring VHF/UHF listings as well. It costs \$6.95 and is available from Handler Enterprises, P.O. Box 48, Deerfield, IL 60015.

Tom Kneitel's *Top Secret Registry of U.S. Government Radio Frequencies* is available for \$4.95 from CRB Research, P.O. Box 56, Com-mack, NY 11725. Only VHF and UHF frequencies are listed.

The new *Betty Bearcat Frequency Directory* is available in two editions: Eastern and Western United States. Either costs \$12.95. It lists public safety, government, and transportation frequencies. It's available from the Scanner Association of North America, Suite 1212, 101 East Wacker Drive, Chicago, IL 60601.

Among hobby scanner clubs, two organizations stand out. The Radio Communications Monitoring Association is a truly professional organization, and its monthly magazine shows it. Send for a free sample copy by writing: RCMA, P.O. Box 4563, Anaheim, CA 92803.

A hobby-scanner users club, SCAN, publishes *Scanning Today*. Loosely sponsored by the Electra Company, its magazine is published bi-monthly and features articles of interest to scanner listeners. For more information, write to: Scanner Association of North America, Suite 1212, 101 East Wacker Drive., Chicago, IL 60601.

SX-100).

Regency's first programmable scanner, the *Whamo-10*, proved to be awkward to use with its frequency combs, and bulky when combined with its accessory control unit. It was also very expensive.

The first programmable scanner to enjoy widespread acceptance was Electra's *Bearcat 101*, even though initial units had problems like overheating, and sometimes "lost" programmed channels stored in memory. But the rapid introduction of competitive receivers from Radio Shack, Regency,

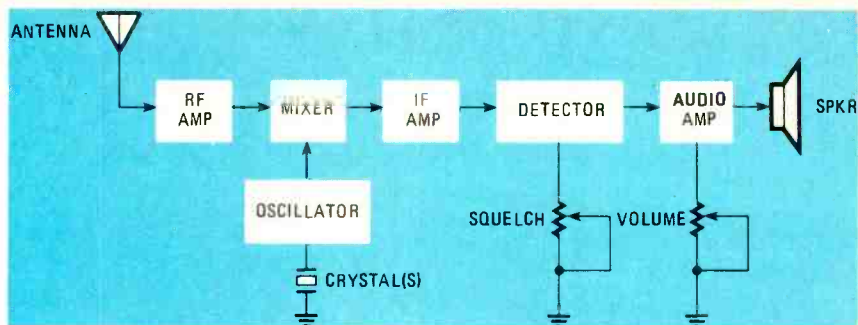

FIG. 1—SIMPLIFIED BLOCK DIAGRAM of a crystal-controlled receiver. The operating frequency is determined by the resonant frequency of a replaceable quartz crystal.

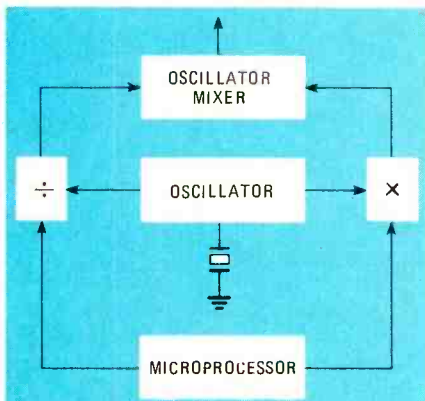

FIG. 2—THE MASTER OSCILLATOR, a combination of frequency dividers, multipliers, and mixers operating under microprocessor control, can generate a wide range of frequencies.

and even Electra itself, reduced the *Bearcat 101's* lead.

State of the art

Modern scanners have come a long way since the early days. Regency's first real programmable, the *model ACT-T-16K Touch*, has been replaced by the *model K-100*, *model K-400*, *model K-500* (shown in Fig. 4), *Digital Flight Scan*, and *model M-100*.

Radio Shack has replaced their classic *PRO-2001* with two newer models, the *PRO-2002* and *PRO-2008* (shown in Fig. 5).

The largest selection of new programmables has come from Electra. The *Bearcat 250*, *Bearcat 211*, *Bearcat 220*, *Bearcat 300*, and *Bearcat 160* have all appeared on the market within three years. Electra recently introduced a fully synthesized, hand-held scanner, the *Bearcat 100*.

The *Bearcat 300* is the most expen-

sive scanner presently on the market. It features Service Search, a specially preprogrammed memory that searches the spectrum by service (marine, fire, police, etc.). A total of eleven factory-programmed SERVICE buttons allow instant selection of hundreds of scanning channels for a particular service without having to program discrete frequencies manually into the scanner. The Regency *model K-400* has a similar feature.

A new entry in the frequency-synthesized scanner field is the *Fox BMP 10/60* from ComRadar Corporation (Fig. 7). That receiver can be used as a portable or mobile unit, or as a base station.

Frequency ranges

Typically, scanners cover frequency ranges of 30-50, 144-174, and 420-512 MHz. Some of the newer models also cover the 118-136 MHz aircraft band and aircraft tower OMNI and VOR transmissions. The *Bearcat 5/800* crystal scanner covers the 800 MHz "micro-wave mobile" band.

Antennas

While scanner manufacturers normally include a small plug-in antenna, that type of antenna is not suitable for receiving distant stations; an outdoor antenna is recommended. But, because large antennas also capture large amounts of local signal, some problems may result. One of those problems is intermodulation, the appearance of the same signal at several places within the tuning range of the scanner. That problem is different from image interference, which will always be heard at a fre-

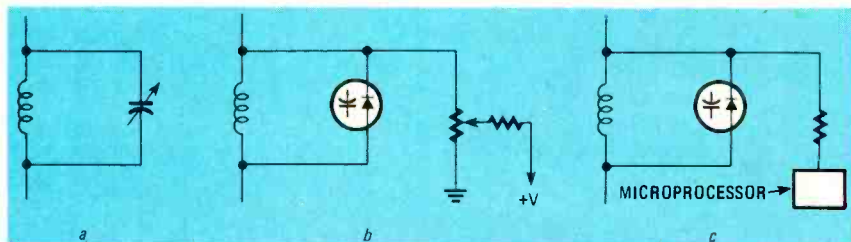

FIG. 3—A TUNED CIRCUIT (shown in a) can be voltage-tuned using voltage-variable capacitors (varactors) as shown in b. In today's synthesized scanners, the varactors are controlled by a microprocessor (c).



FIG. 4—THE TOUCH K500 from Regency uses a touch-sensitive keypad instead of conventional pushbuttons.



FIG. 5—REALISTIC MODEL PRO-2008 is a six-band, frequency synthesized, programmable scanner.

quency that is twice the intermediate frequency of the receiver away from the carrier frequency. This sounds confusing at first, but it is easy to calculate. For example, Regency and Radio Shack receivers typically have an IF of 10.7 MHz; twice that is 21.4 MHz. If a very strong mobile telephone signal is heard at 152.54 MHz, chances are a weaker image signal will also be present at 173.94 MHz ($152.54 + 21.4 = 173.94$).

Image interference can sometimes be used to receive frequencies that are below the normal range of the scanner; the signals will be much weaker, but they will be there nonetheless. For example, some early programmables would not tune all the way down to 144 MHz, the low end of the two-meter amateur band, but images of two meter signals could be copied near 165-166 MHz if the signals were strong enough.

In some cases intermodulation may



FIG. 6—THIS COMPACT SCANNER, for the Fox BMP 10/60 from ComRadar Corporation, features 60 pre-programmed frequencies.

be reduced by turning a directional beam antenna away from the interfering signal.

Scrambled transmissions

Many law enforcement agencies are very concerned about the number of people who are eavesdropping on their sensitive messages. While the vast majority of listeners are merely curious, there are some who use scanners to

elude the law while committing a crime. For that reason, some agencies use scramblers to encode their transmissions. A few manufacturers sell decoders that defeat the most common form of scrambling: speech inversion. Advertisements for the decoders frequently appear in various hobby radio magazines.

Because of the ready availability of those decoders, some agencies have switched to more sophisticated voice-encoding techniques. One of those, Motorola's DVP (Digital Voice Protection) is said by the manufacturer to be virtually unbreakable. Will consumer technology eventually break the unbreakable code? Only time will tell.

Where to listen

A great deal of exciting listening is waiting for you out there; all you need to know is where to look! Low band (30-50 MHz) is used primarily for wide-area coverage. Military training exercises, National Guard units, State Police systems, and construction and freight companies are among the things that can be heard in this portion of the spectrum.

High band (151-174 MHz) is the most congested part of the VHF/UHF spectrum. Mobile telephone, business, and public safety communications dominate the first 11 MHz, while 162-174 MHz is used almost exclusively by the Federal Government.

The UHF band (450-512 MHz) is used mostly in metropolitan areas where high-band congestion poses a problem to new radio systems. Assignments in the UHF band are very systematic. Repeaters, high-powered transmitters that rebroadcast weak signals received from mobile and portable units, are found either 5 MHz lower than the original signal (between 450-470 MHz), or 3 MHz lower (between 470-512 MHz).

Table 1 is a listing of services and the frequency ranges (in MHz) in which you're most likely to find them. You should note that the ranges given are approximate.

In addition to the frequency ranges given in the table, police, fire, and medical assignments are shared throughout the following UHF frequency ranges: 470.3-471.2, 473.3-474.2, 488.3-489.2, 491.3-492.2, and 494.3-494.4 MHz.

In conclusion

The scanner is a fascinating instrument. It features electronic sophistication hardly dreamed of ten years ago. Advances made possible by the space program, and the CB boom let home hobbyists tune in to a world of excitement. What does the future hold in store? We can only guess, but until then, take your pick from some of the finest consumer technology available.

TABLE 1
(Frequencies in MHz)

Police	Fire	Medical	Fed. Gov't.	Marine	Mobile Tel.	Ham
37.02-37.42	33.42-34.0	33.0-33.1	30.0-30.56	156.25-157.4	35.26-35.7	144-148
39.0-39.98	46.03-46.5	37.9-38.0	32.0-33.0	161.6-162.0	43.26-43.7	420-450
42.0-42.94	154.0-154.5	47.0-47.65	34.0-35.0		152.0-152.2	
44.62-46.02	159.0-159.2	49.6-50.0	36.0-37.0		152.51-152.81	
154.65-156.0	453.0-454.0	151.0-151.13	38.0-39.0		158.49-158.67	
453.0-454.0	458.0-459.0	155.16-155.4	40.0-42.0		454.0-455.0	
458.0-459.0		156.0-156.25	138-144		459.0-460.0	
460.0-460.5		462.9-463.2	148.0-150.8			
465.0-465.5			162.025-173.2			
			173.4-174.0			
			406.0-420.0			

BUILD THIS

Musical Horn

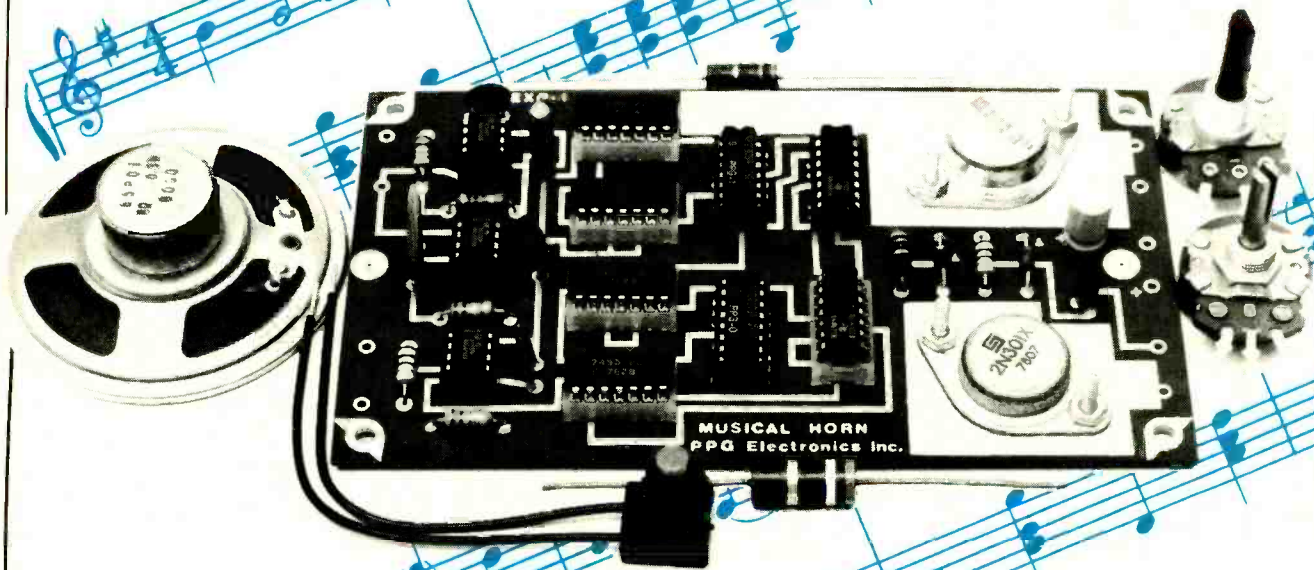

For Your Car

FRED BLECHMAN and
DAVID McDONALD

*Give your car a distinctive sound with this musical "accessory."
It should take you less than an hour to assemble.*

Part 2 WE WERE EXAMINING how tones were generated by the musical horn when we stopped last month. Now we'll finish up.

Whenever a match is found between the output from IC8 and the output from IC9, then IC6 and IC7 are reset at the frequency of the note called for by IC8, until the input to IC8 changes. The greater the number of counts IC6 and IC7 produce before reaching the IC8-IC9 matching-address, the longer the time period for each reset cycle, and therefore the *lower* the frequency of the note that is produced.

Let's use some actual numbers to illustrate this. Suppose IC3 is adjusted by R5 to pulse at 87560 Hz. To produce a 220-Hz musical note, "A," binary code 0011 (decimal 3), at address 199 of IC9, is used. Each second IC3 counts up to that memory location 440 times (87560/199=440). Each time location 199 is reached, a 0011 output appears at the "B" input of IC10. With the "A" input to IC10 also 0011, a pulse appears at IC10 output-pin 6—in this case, at the

rate of 440 times per second. This is converted to a square wave with a frequency of 440/2, or 220 Hz, by flip-flop IC11-b, and this is the frequency fed to the amplifier.

Using the same IC3 pulse rate, if the musical note "E" (decimal 7) were specified by IC8, then address 133 of IC9 would contain the matching binary code (see Fig. 6) and would cause IC10 to output pulses at the rate of 658.35 per second (87560/133=658.35). That would be divided in half by IC11-b to 329.18, very close to the ideal 329.63-Hz frequency of "E-above-middle-C." Figure 6 shows all the musical notes programmed in IC9 by location, along with the decimal code notation used in Fig. 1. (Figures 1 and 6 appeared in last month's issue.)

The 7473 dual J-K flip-flop, IC11, requires a little explanation. Input K of IC11-a is connected to V_{CC} . Since J is low, Q is low. Whenever input J goes high (because of an output pulse from IC10), the next time the clock pulse from pin 3 of IC3 goes low, the Q output

(pin 12) of IC11-a goes high and resets IC6 and IC7. That stretches the length of the reset pulse to equal the duration of the clock period of IC3, making it wide enough to be recognized by IC11-b. The resetting routine may occur hundreds of times per second, depending on the settings of R1 and R5, and on the note and duration called for by the song PROM.

With both J and K inputs tied to a positive voltage, IC11-b is used as a toggle flip-flop. Every time the Q output of IC11-a goes low, it clocks IC11-b and causes the IC11-b Q output, at pin 9, to change state. The result is a square wave output from IC11-b equal in frequency to one-half the IC10 pulse frequency. The squaring of the IC10 pulses results in a sound more closely resembling that produced by a sine wave.

Positive halves of the square wave from pin 9 of IC11-b pass through dropping resistor R8 and isolation diode D1 to bias NPN transistor Q1 into conduction. That path now provides, through R9, the forward base-bias for power transistor Q2 to conduct heavily,

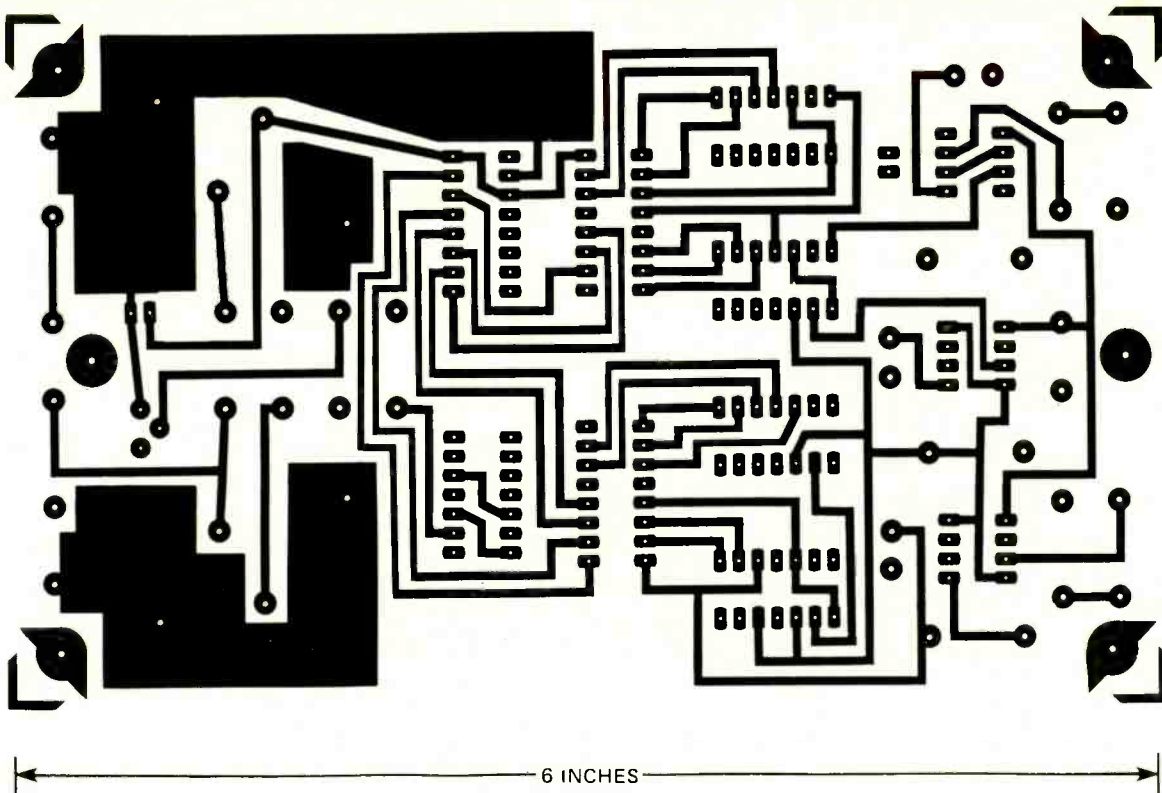

FIG. 7—PATTERN FOR FOIL SIDE of double-sided PC board. See Parts List for availability of ready-to-go boards if you don't want to make your own.

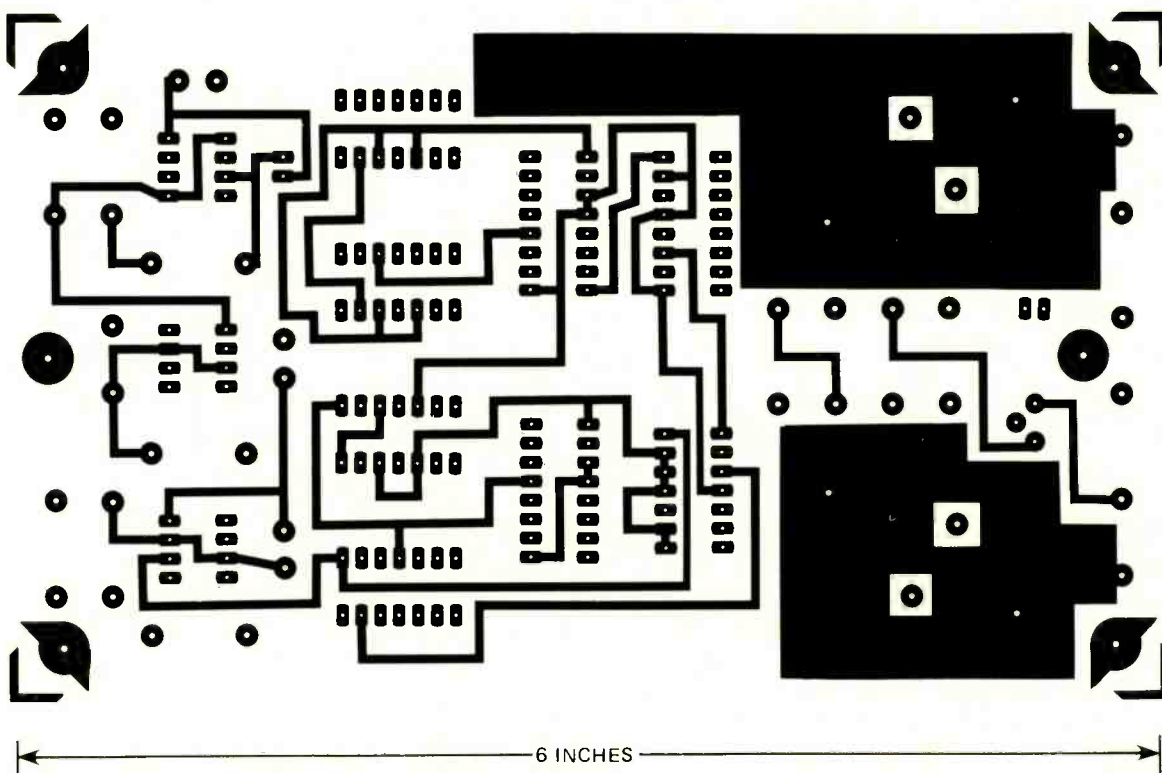

FIG. 8—COMPONENT-SIDE foil pattern. Both sides of the board must be in perfect register. Holes should be plated-through.

passing current through the speaker coil. Resistor R10 is a 2-watt series current-limiting resistor which must be used with speakers rated at less than 10 watts, as shown in Table 1.

A five-volt regulator, IC12, is protected from reverse-voltages by diode D2. Its output is filtered by C6. Switch

S1 is used to operate the horn.

A song can be played in different keys as each note is not "locked-into" a specific frequency. In a musical scale each note bears a fixed mathematical relationship to every other note. You can vary the frequency of the notes as long as all the notes maintain the same

relationship. PROM IC9 establishes that relationship, so you can vary song-speed with R1 and change the pitch (key) by adjusting R5.

One final note: When IC8 is programmed for "silence" (binary 0000) it actually causes "matching" at an ultrasonic frequency with the first address in

TABLE 1

SPEAKER RATING	RESISTOR (R10)
.25 watt	39 ohms
.5 watt	27 ohms
1 watt	16 ohms
5 watts	3 ohms
10 watts	none

Note—If a speaker rated at less than 10 watts is used, a current-limiting 2-watt resistor must be used in series with the speaker.

IC9, which also is binary 0000. This causes slightly more current than might be expected to be drawn from the battery, due to the high-speed saturation effects of Q1 and Q2 (fast turn-on and slow turn-off).

Construction

You can build this project on construction board, or use the double-sided printed circuit board layouts shown in Figs. 7 and 8. However, if you make your own boards you must be very careful to have good registration between the top and bottom surfaces. Furthermore, unless you are able to plate through the holes after drilling, you will have to solder each component on both sides of the board, since many circuit paths depend on continuity through the board!

Frankly, the double-sided, plated-through PC board offered for this project (see Parts List in last month's issue) is the most practical way to go. A parts kit, including sockets for all IC's and the tone PROM, but not including case, is also available.

Assembly should take less than an hour, and requires no special techniques. Use a small-tip 25-45 watt soldering iron and good rosin-core solder. All parts are mounted on the component side of the board. Insert and solder all

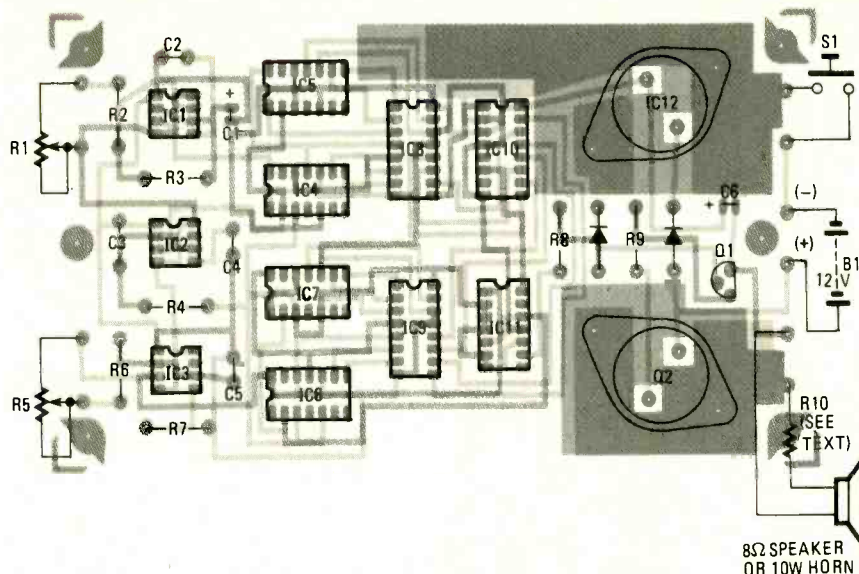

FIG. 9—BE CERTAIN that diode and capacitor polarities are correct. Packages for IC12 and Q2 are nearly identical—do not confuse one for the other.

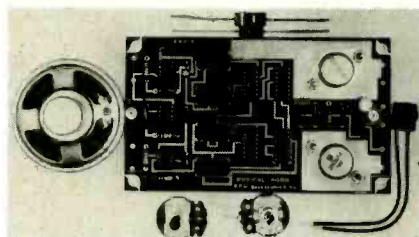

FIG. 10—COMPONENTS SURROUNDING BOARD can be mounted along with it in plastic case under the dashboard. The speaker or horn, of course, is located behind car's front grille.

the resistors first; be very careful to get the right values in the proper locations, as shown in the parts-placement diagram (Figure 9). Install all the IC sockets next, being careful not to install 14-pin sockets in 16-pin locations! Bend down the corner pins of each socket on the underside of the board to hold the socket firmly in place before soldering. Now install the two diodes (watch the polarity—the banded ends should point toward IC12). Next install the three

small flat disc capacitors and then the larger one. Be careful when you install the two electrolytic capacitors; they are different values and also must be oriented correctly.

Transistor Q2 and voltage regulator IC12 look alike—don't mix them up! IC12 is clearly marked "LM309 or LM340", but Q2 may have numbers other than "2N301" (such as SP-2540.) Put each one in the proper location and secure it to the printed-circuit board with 6-32 hardware. Now insert and solder the small transistor, Q1.

You can either program the two PROM's, IC8 and IC9 (N82S129's or 74S287's) yourself (see the "Inexpensive PROM Programmer" in the February 1981 issue of Radio-Electronics), using the information provided last month in Figs. 3 and 6, or obtain them pre-programmed from the source indicated in the Parts List.

Insert the IC's into their sockets, being careful that the notched or indented (pin-1) ends are oriented as shown in Fig. 9.

The finished board should look like the one in Fig. 10.

Checkout

You should test the unit before packaging it up. Solder short leads (bare wires clipped from resistors after soldering them to the board, for example) to the PC-board pads that will connect to the two electrolytic capacitors, the switch, the power supply, and the speaker. Use alligator-clip leads to make the test connections from them to the outboard components. When connecting the potentiometers, the center and left terminals (looking at the front of the potentiometers) are the active ones. The right terminal can be left unconnected or wired to the center terminal, as you wish—it makes no difference electrically. The

continued on page 100

PARTS LIST

Resistors ¼-watt, 5% unless otherwise specified
 R1—100,000 ohms, potentiometer
 R2, R7—10,000 ohms
 R3—1000 ohms
 R4—100,000 ohms
 R5—500 ohms, potentiometer
 R6, R9—100 ohms
 R8—330 ohms
 R10—see Table 1

Capacitors
 C1—1 µF, electrolytic
 C2, C4, C5—0.01 µF, ceramic disc
 C3—0.1 µF, ceramic disc
 C6—10 µF, electrolytic

Semiconductors
 IC1-IC3—555 timer
 IC4-IC7—7493 4-bit binary counter
 IC8, IC9—N82S129 or equivalent 256 × 4-bit PROM (see below)
 IC10—7485 4-bit magnitude comparator
 IC11—7473 dual JK master/slave flip-flop

IC12—LM309K, LM340K or 7805K 5-volt regulator
 Q1—2N3904 or similar
 Q2—2N301
 D1, D2—1N4003, 200 PIV
 S1—N.O. momentary pushbutton switch
Miscellaneous: PC board, 8-ohm speaker or horn, IC sockets, hardware, etc.

NOTE: The following are available from PPG Electronics, Dept. RE, 14663 Lanark St., Van Nuys, CA 91402: Complete kit including PC board and all parts except case and IC8 (No. 1082), \$39.95; PC board only (No. 782), \$11.95; IC9 tone PROM (PPG-0), \$6.95; IC8 song PROM ("Cucaracha": PPG-1, "Dixie": PPG-2, "Charge": PPG-3), \$6.95 each; 2N301 output transistor, \$1.99. Add \$2.00 shipping & handling for orders within U.S. CA residents please add 6% tax.

BUILD THIS

Part 2 ALTHOUGH YOUR 8-Ball antenna is starting to look like the finished product, we'll finish the lattice and install the screen.

Before installing the adjustment bolts in the ends of the two outermost vertical strips, cut a piece of $\frac{3}{4} \times 2$ -inch strip long enough to reach across the corner adjustment bolts. Drill a hole at each end to match the position and size of the adjustment bolts and install as shown in Fig. 10.

Cut another piece of $\frac{3}{4} \times 2$ -inch strip to fit cross the corner in between the vertical strips and install it across the corner between the vertical strips. It must be on top of the first diagonal-corner strip and underneath the horizontal strips as shown in Fig. 11. Finish across the corners and down the sides with $\frac{3}{4} \times 2$ -inch filler strips cut from scrap and installed as shown in Figs. 12 and 13 respectively. Those filler strips are necessary in order to do a good job of stretching the screen. Attach all short pieces with brass wood screws. Trim off the excess ends of the strips with a saw and tighten all of the adjustment bolts. That completes the frame and lattice, and the assembly should look like Fig. 4.

SATELLITE TV ANTENNA

In this part, we'll complete the assembly of the basic 8-Ball antenna and begin to get it ready for mounting.

Installing the screen

Study the assembled frame from all angles, making sure that its curves are uniform. Be sure that all adjustment bolts are secure.

Up to now, we have not needed to do any precision assembly. However, the screen **must** be installed properly (meaning good and tight). If possible, move the antenna close to the spot where it will be located before beginning.

Start rolling out the first run of screen so one edge is on the middle horizontal strip of the lattice (Fig. 14). The screen is 26 inches wide. That allows for a good overlap as the screen runs repeat every 24 inches. There are six runs of 12 feet each—requiring a total of 72 feet of material.

Align the screen so that one overlap falls on the middle horizontal strip and another overlap falls on the third strip up (all overlaps should be equal). Leave equal overhangs at the ends. Use $\frac{1}{4}$ -inch or $\frac{3}{8}$ -inch long rustproof staples—whichever works best in your staple gun. The staples should drive into the wood far enough to hold the screen snugly—without going in far enough to cut the screen. Start with four or five staples in the center of the antenna at

H.D. McCULLOUGH



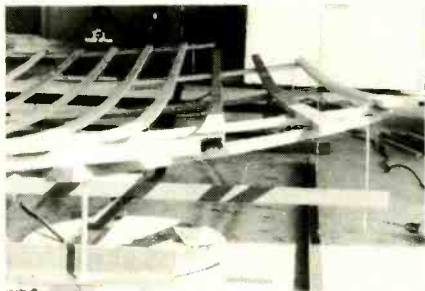

FIG. 10—A PIECE of $\frac{3}{4}\times 2$ -inch stock, long enough to reach across the corner bolts, is installed in each corner as shown.

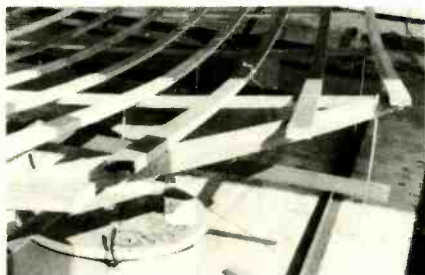

FIG. 11—ANOTHER PIECE OF $\frac{3}{4}\times 2$ -inch stock, cut to fit between the vertical strips, is installed on top of the first so it is even with the vertical strips.

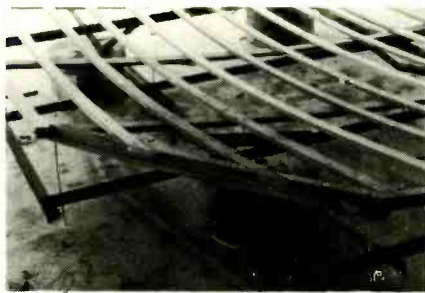

FIG. 12—MITERED STRIPS, cut from $\frac{3}{4}\times 2$ scrap, are fitted between the ends of the horizontal strips so that the frame edge is level for attaching the screen.

one edge of the screen (Fig. 15). Pull tightly **straight** across and staple the other side as shown in Fig. 16. Now, put three or four staples into each of the two strips in between.

Go to one end of the screen and pull it tight enough to cause it to "stretch" straight across from center to the edge. **Don't pull the screen too tight**—that will make it pucker near the middle! Again, staple one edge first, then stretch the screen tightly and staple the other corner. Now, pull the screen toward you hard enough so it has uniform tension and add several staples across the end of the screen (see Fig. 17).

Halfway between one end and the middle of the screen run, pull the far side of the screen away from you a bit ($\frac{1}{4}$ to $\frac{3}{8}$ -inch is OK), and put in four or five staples. Pull the screen tight and add four or five staples directly across from those you just put in. Now, staple the screen to the strips in between.

Move to a point halfway between two previously stapled points, put a staple in one edge, and then pull the screen di-

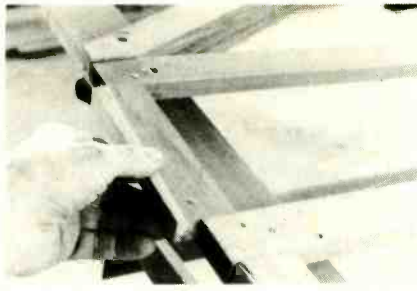

FIG. 13—SHORT PIECES OF $\frac{3}{4}\times 2$ are cut to fit between the ends of the horizontal ribs in the lattice. They also provide an even surface for attaching the reflector screen. Brass screws hold each piece in place.

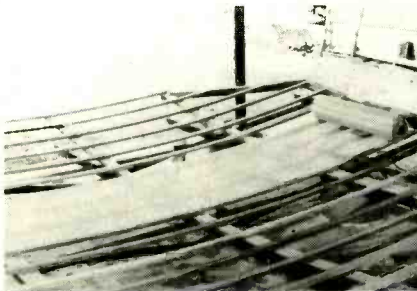

FIG. 14—START COVERING THE FRAME by rolling out the screen in a strip with one edge overlapping the center horizontal lattice strip.



FIG. 15—KEEP TENSION ON THE SCREEN as you place the staples until you have tacked all around the edges. When working with the first strip of mesh you will have to stand between slats in the lattice.

rectly across from that staple and add another staple. Continue until the entire run of the screen has been stapled in place. Don't skimp, use one staple every three inches near each side of each wood strip. Figure 18 shows one run of screen firmly stapled in place.

Install the remaining five runs of screen the same way.

Next we'll show you how to cut and install the rear legs and braces. We recommend that you don't do that part of the construction at this time since the length of the rear legs depends on your location relative to the location of the satellite(s) you wish to receive. (Complete information on how to aim the antenna will be given next month and you'll be able to proceed then.) For now, put the antenna up on blocks so it doesn't warp.

Figure 19 shows the legs and braces that support the antenna. Prepare rear legs RL1 and RL2 by attaching rear-leg extensions RLX to get the desired tilt angle. If you are not working with a kit,



FIG. 16—AFTER STAPLING ONE EDGE, keep the screen taut and staple the point directly across from the first.



FIG. 17—PULL THE ENDS tight enough to keep the screen straight from center to edge. But, don't pull too tight—the screen may pucker in the middle.

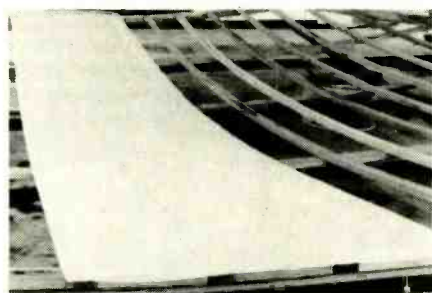

FIG. 18—ONE STRIP OF SCREEN completely anchored in place. When you've finished there will be one staple about every three inches.

you'll have to drill holes in VR2, VR4, RL1, RL2, and leg extensions RLX. Drill four holes in VR2 and VR4 (see Fig. 20-a). Above the center line, drill holes at 4 inches and 48 inches. Below center, drill holes at 48 inches and 68 inches. In RL1 and RL2 drill holes 1 and 48 inches from the top end and 1, 3, and 5 inches from the bottom (see Fig. 20-b). Use special care in spotting the holes drilled and remember that you will have right- and left-hand members. Drill $\frac{1}{4}$ -inch holes 2 inches apart along the length of RLX. Drill holes in braces B6 $\frac{1}{4}$ inch apart for 12 inches from one end.

The tilt angle and base pad dimensions (see Table 1) are determined by your longitude and latitude, and the satellite(s) that you want to receive. That will be covered in detail next month.

Move the antenna off the support blocks and place two short 2×4 's (or blocks) under the BF base across the bottom of the antenna to prevent bending the bottom row of adjustment bolts. Raise the top of the antenna three or

HOW THE 8-BALL GOT ITS SHAPE

The reflector most often used in TVRO (TV Receive-Only) antennas is shaped like a parabola as shown in Fig. 1. Its design is based on the

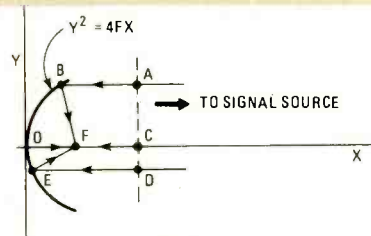

FIG. 1

equation $y^2=4fx$ where f is the distance from the center of the antenna to the focal point. A characteristic of the parabolic shape is that all signals from far away will be reflected to the focal point. This assumes that the antenna is pointed exactly toward (bore-sighted at) the signal source.

A second characteristic of the parabola is that the distance traveled from point A to point B to point F is the same as the distance from C to O to F and from D to E to F; with points A, C, and D lying on a line parallel to the Y axis. In that case, all signals reaching the focal point are in phase with each other and add together, no matter what part of the dish they are reflected from.

A horn is generally used to couple the signal at the focal point to the LNA waveguide. Its size is selected to match the F/D ratio (focal length: diameter) of the reflector. Most TVRO antennas have a F/D ratio in the range of 0.3 to 0.5. A 12-foot parabola with a 0.4 F/D ratio would be about 22½ inches deep.

The reflector surface of the 8-Ball is *spherical* rather than parabolic. It is like a 12-foot-square section cut from the surface of a sphere (ball) 60 feet in diameter (see Fig. 2). The

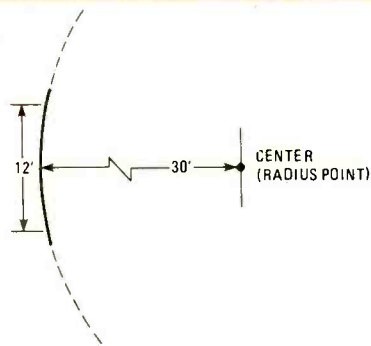

FIG. 2

depth of the 8-Ball reflector is about 7¼ inches (7.27347 inches, to be exact). On the other hand, if a 12-foot parabolic antenna were built with a 15-foot focal length, it would be 7.2 inches deep. Thus, the difference between the surface of the

spherical antenna and a true parabolic antenna is only about ¼ inch (about 0.025 wavelength at 4GHz), and that much difference only occurs at the extreme edges of the antenna. The difference is much less at most points on the reflector surface.

There are, however, several practical advantages to the spherical reflector. One is that it can be easily checked for accuracy using a simple 30-foot radius-wire. Remember all points on the surface are the same distance from the radius point, being spherical, the curve is the same all over the dish. That means, that for the amount of curvature in the 8-Ball, it will function with good efficiency even if it is aimed to a point as much as 15 degrees either side of the exact location of the satellite (or up to 20 degrees in most areas of the U.S.). Thus the spherical dish can be used to receive signals from more than one satellite at a time, so long as the difference between the look-angles of the two (or more) satellites is less than about 30 degrees—although the difference in look-angles can be as much as 40 degrees in areas with strong signal levels.

A very useful advantage of this antenna is the fact that the reflector can be mounted in a fixed position and all satellites with look angles up to 15-20 degrees on either side of the bore-sight direction can be received simply by moving the feed horn to the proper focus point. This is shown in Fig. 3. Use two or more LNA/feed horns if you would like to receive two or more satellites simultaneously.

Still another advantage of the spherical reflector is that for elevation look angles of 30° or less, if you tilt the 8-Ball back from the vertical an amount equal to half the look angle, the focal point will be level with the center of the dish or about six feet off the ground (Fig. 4-a). That is a convenient height for the feed horn—particularly if you plan to shift the feed horn about to receive several satellites. (If it is necessary to have the feed horn lower than the center of the dish, you must cover the opening with something to keep the rain out because in that position, the horn is

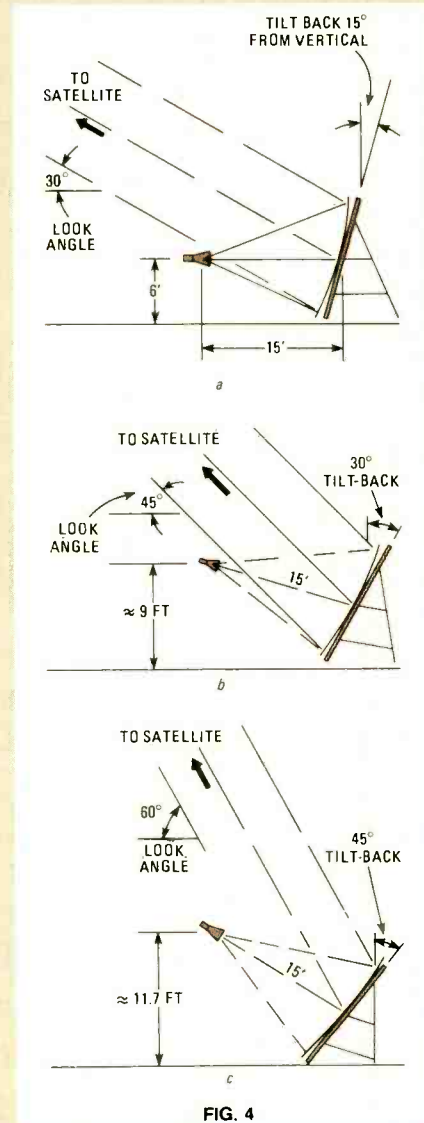
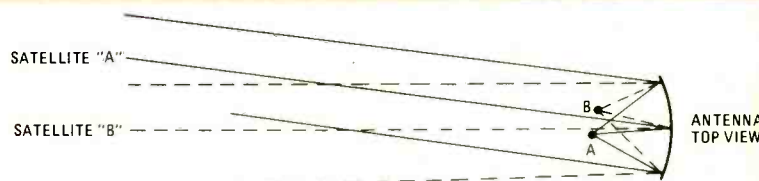

FIG. 4

pointing up toward the center of the antenna.)

For elevation-look angles of over 30 degrees, the feed horn must be mounted higher off the ground because you shouldn't have more than 15 degrees difference between the satellite look-angle and the pointing angle of the dish. Figures 4-b and 4-c show how the feed horn height must be increased as the elevation look angle increases. In those cases, the tilt-back angle is 15 degrees less than the look angle.

R-E



NOTE: FOCUS POINT IS 15 FT. FROM CENTER OF DISH.

FIG. 3

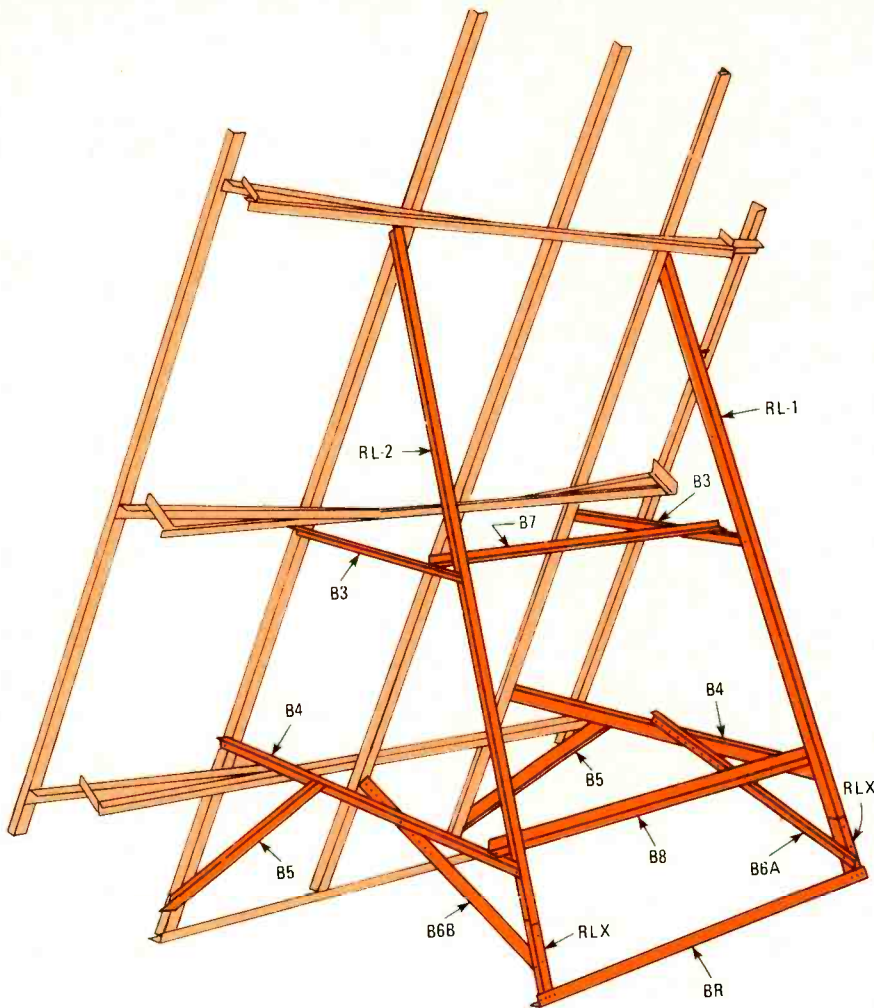

FIG. 19—THE REAR LEGS and the braces set the tilt of the reflector surface. Tilt is adjusted by lengthening or shortening the rear legs.

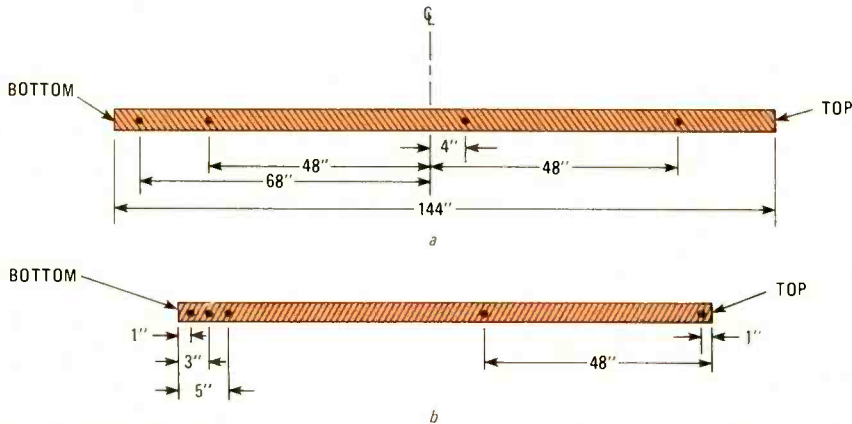

FIG. 20—DRILL HOLES in VR2 and VR4 as shown in a. The holes in RL1 and RL2 are drilled as shown in b.

TABLE 1

Antenna Tilt Angle (Degrees)	RL Length	Base Pad Dimensions	
		(A)	(B)
6	11' 7"	7' 0"	8' 2"
8	11' 4"	6' 11"	8' 1"
10	11' 1"	6' 9"	8' 0"
13	10' 7"	6' 6"	7' 11"
17	10' 1"	6' 4"	7' 10"
21	9' 7"	6' 2"	7' 9"
26	9' 1"	6' 0"	7' 8"
31	8' 7"	5' 11"	7' 6"
37	8' 0"	5' 9"	7' 4"



FIG. 21—THE TOP END OF THE ANTENNA is raised three to four feet off the ground so rear legs RL1 and RL2 can be attached. Put small blocks under the lower end to protect the corner adjustment bolts.

four feet off the ground and attach rear legs RL1 and RL2 as shown in Fig. 21.

Raise the antenna into place. The rear legs will slide into place. BE VERY CAREFUL when raising or moving the antenna until it is secured on the base pads. It can twist out of shape if one side is lifted more than the other. That can cause the screen to stretch and become loose. NEVER stand the antenna up until you are prepared to anchor it securely. It will blow over if the wind speed is 20 to 30 mph from the rear.

Install braces B3, B4, B5, B6, B7, B8, and BR in the order listed (see Figs. 19 and 22). The antenna is now complete and ready to be placed on the base pads.

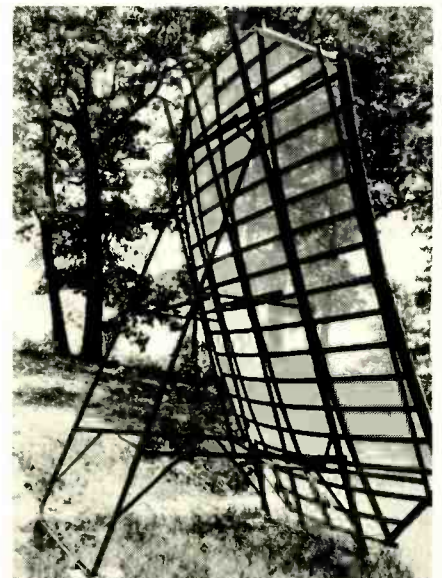
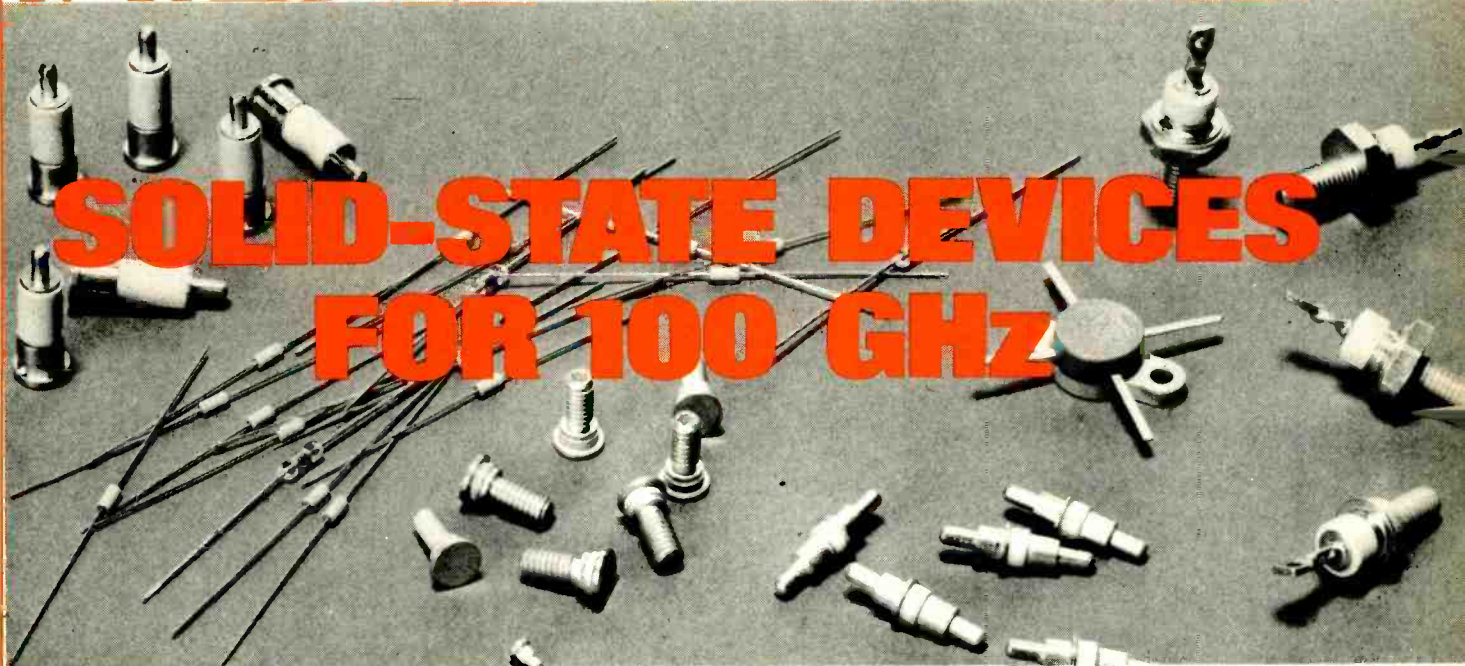

FIG. 22—REAR VIEW of the 12-foot 8-Ball antenna. All of the rear-support members are clearly visible.

That finishes the assembly of the basic 8-Ball antenna. Next month we'll show you how to find the satellites that you're interested in, pour the concrete basepads, mount the antenna, and adjust the reflector for best reception. R-E



SOLID-STATE DEVICES FOR 100 GHz

Higher and higher frequencies require better and more efficient microwave generators. These devices represent the current state-of-the-art.

JOSEPH J. CARR

Part 3 AS WE SAW LAST month, RCA successfully developed a higher efficiency microwave generator in 1967. But there was some disagreement on how RCA's TRAPATT worked.

Cornell University physicists offered a somewhat different explanation of the high efficiencies observed. The Cornell theory maintained that avalanche resonance pumping was the responsible mechanism, so advanced the acronym ARP. The Bell Labs view seems to have prevailed. The difficulty in determining the proper theory of operation caused a two-year delay between the first observations of the TRAPATT mode and the explanation of how it worked. Part of the problem is that TRAPATT operation is not amenable to small-signal analysis, so the correct theory had to be worked out somewhat more laboriously than would have otherwise been possible.

It has been demonstrated that ordinary PN junction diodes (silicon) can be made to oscillate in the TRAPATT mode. It is, however, rather tricky to adjust such circuits, so they do not find much application. Most commercial TRAPATT devices use the p^+n-n^+ structure of the single-drift IMPATT. A typical TRAPATT device is shown in Fig. 16-a.

The structure of the TRAPATT device is very similar to that of the

IMPATT. In fact, some TRAPATT devices will oscillate in either the TRAPATT or the IMPATT modes, depending upon the bias and other circuit conditions. It is noted that numerous TRAPATT oscillators actually start out in the IMPATT mode for a few nanoseconds after turn-on, and then convert to the TRAPATT mode when certain circuit conditions are satisfied. To make the device switch from the IMPATT to the TRAPATT mode, we need to drive it hard with a current

pulse. Since the risetime of that pulse must be very short, it is usual to use the IMPATT mode to generate the pulses. (It is very difficult to obtain the risetimes needed with external circuitry.)

What is a trapped plasma (the "TRAP" in "TRAPATT"), and how ever there is a large density of charge carriers (holes and electrons) present. If the electric field in that region is very low, then the plasma is said to be *trapped*, i.e., it takes a long time to sweep carriers out of the region under the influence of the electric field. The carrier velocity is considerably lower than the saturation velocity.

Figure 16-b shows the electric-field distribution within the n-region. The device is biased to just punch-through; i.e., the depletion zone reaches through the entire length of the n-region, but is biased at a point less than the avalanche voltage V_Z . The slope of the electric field (Fig. 16-b) is dependent upon the charge density. Because we are operating in the punch-through region, there will be no free charge-carriers present.

If we excite the TRAPATT diode with a large, fast-risetime current pulse, I_0 , then we will observe a point in the constant-bias field V_B move as an avalanche shock front. We find that the velocity of that shock front can be faster than the saturated velocity of the holes and electrons, a phenomenon that

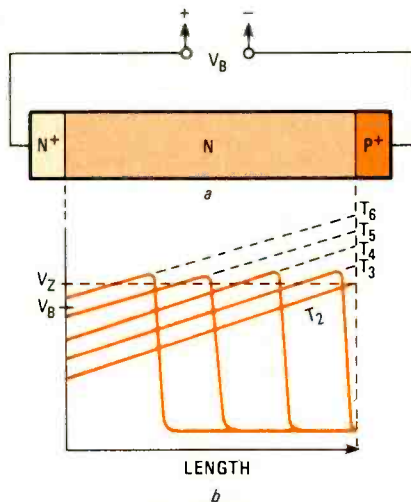

FIG. 16—TYPICAL TRAPATT device uses the p^+n-n^+ structure of the single-drift IMPATT. Electric-field distribution in the region is shown in b.

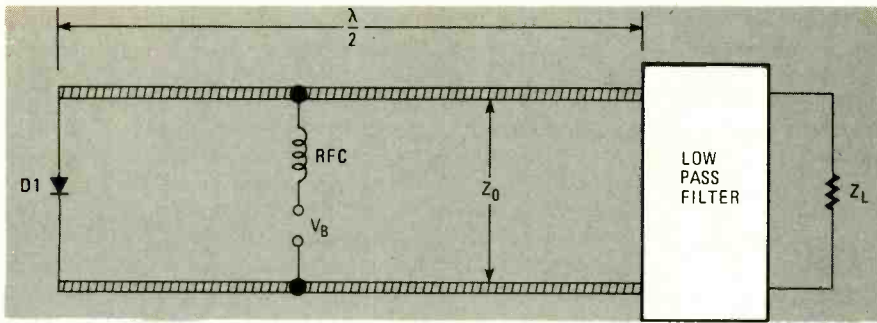

FIG. 17—A FAST-RISING, nearly square, current pulse is applied to a half-wavelength transmission line that has a TRAPATT device at its end.

is much like the behavior of water waves at the beach striking the shore at an angle. Typical times for the avalanche shock front to traverse the n-region are around 100 picoseconds.

Notice what happens to the terminal voltage in Fig. 16-b. Shortly after the initiation of each shock front, the terminal voltage drops from a very large value down to a very small value. The falltime of that drop is very rapid, so the TRAPATT operates as a very fast, low-impedance electronic switch. If we were to place the diode at one end of a half-wavelength transmission line as shown in Fig. 17, then that phenomenon would result in a pulse being applied to the transmission line. The current pulse has a fast risetime, and a wave-shape that is nearly square, so it is rich in harmonics. The harmonics are taken out by a lowpass filter so that the fundamental could be applied to the load Z_L . The value of the current pulse will be $I = V_B / Z_0$, where V_B is the applied bias potential and Z_0 is the characteristic impedance of the transmission line.

The description above required a current pulse to be applied to the TRAPATT diode before the TRAPATT mode could be realized. That pulse could easily be an IMPATT pulse when

the device is operating in the IMPATT mode. But the TRAPATT mode will build up in a nearly exponential manner until it becomes self-sustaining. The foregoing discussion does not explain how the TRAPATT mode could become self-oscillatory. For that type of operation we must rely on the actions of the lowpass filter at the end of the resonant half-wavelength transmission line. It will transmit energy at the fundamental TRAPATT frequency, but will reflect energy at the harmonics of the fundamental frequency. Those harmonics are reflected with a phase reversal (i.e., reflection coefficient of -1 in the ideal case) so they will initiate another avalanche shock front. The small rise in the terminal voltage in Fig. 18 is caused by that returning reflection. The return pulse will, then, cause the TRAPATT-mode oscillations to be continuous. In the typical TRAPATT oscillator, the device will begin in IMPATT operation. The IMPATT-mode oscillations will build up in an exponential manner until the current becomes large enough to trigger a shock-front transit. (Hence the use of "triggered transit in" the device's acronym.)

BARITT devices

Consider the p^+n-p^+ structure shown in Fig. 19. That device contains a pair of back-to-back junctions. One of those junctions will be slightly forward-biased, while the other junction is slightly reverse-biased. The flow of current under conditions when the bias voltage is less than the punch-through voltage will be limited by the ordinary leakage current of the reverse-biased junction. If the bias is increased to the point where the device is operated in the punch-through mode, then the depletion region exists across the entire n-region until it reaches the forward-biased junction. That will cause all of the carriers (holes) at the forward-biased junction to be swept across the n-region, causing the current to increase rapidly as shown in Fig. 20. That current can be used in a microwave oscillator provided that the field is large enough to make the holes drift across the n-region at the saturated velocity and the voltage applied is kept below the point at

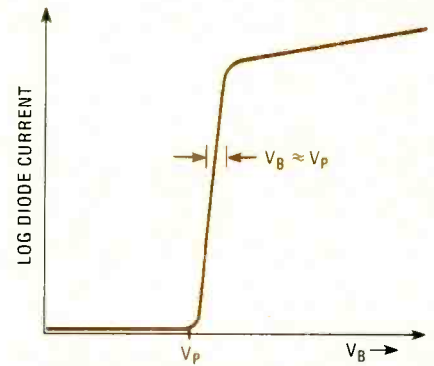

FIG. 20—CURRENT INCREASES rapidly in the BARITT device as the carriers are swept across the n-region.

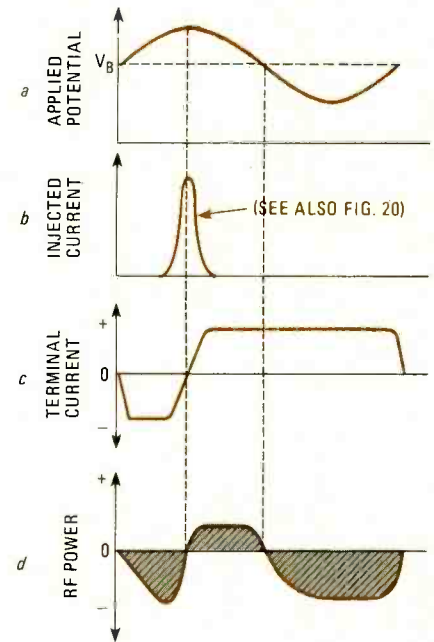

FIG. 21—IF A BARITT DEVICE is operated in parallel with a resonant tank circuit, noise pulses will ring the tank circuit and cause an RF alternating potential to appear across the diode as shown in d.

which avalanching will occur. Devices that use that phenomenon are called BARITT (BARrier Injection Transit Time) oscillators.

Suppose that a BARITT device is biased with a DC potential close to the potential required for punch-through operation. Further suppose that the device is operated in parallel with a resonant tank circuit (as was done in our discussion of the Gunn device earlier). Noise pulses will ring the tank circuit and cause an RF alternating potential to appear across the diode that will add algebraically with the bias potential (Fig. 21-a). When the total bias exceeds the punch-through potential on positive excursions of the RF waveform, a sharp current-pulse is injected (Fig. 21-b). During the period when the injected current is peaking, the terminal current (from the DC bias) is added to it, causing a reversal of the current direction for that period (Fig.

continued on page 93

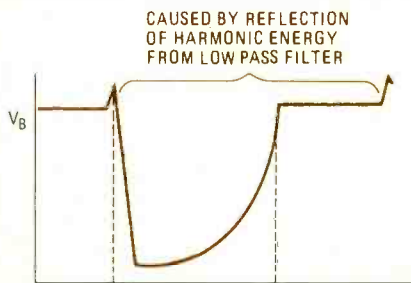

FIG. 18—HARMONICS reflected by a lowpass filter cause the TRAPATT-mode oscillators to become continuous.

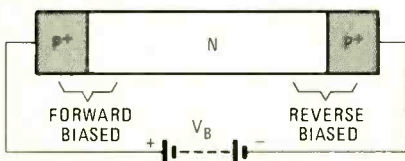

FIG. 19—BARITT DEVICE has two back-to-back p^+ junctions, one of which is slightly forward-biased while the other is slightly reverse-biased.

BUILD THIS

Part 2 WITH THE THEORY OF operation of the Programma-2's control board out of the way (it's always helpful to know what you're doing) we can now start work on the board itself.

Position the board as shown in Fig. 5 and start construction by installing the 24-pin IC socket. After that, install 16-pin sockets in the IC103 and IC102 positions. In the same manner, install a 14-pin socket at IC101 and then two 8-pin sockets at IC106 and J101. That takes care of the IC sockets.

Install crystal XTAL101 next. Push it flush against the board and quickly solder the leads. Don't apply excessive heat, or you may crack the seal.

Now you can install the 100K resistors around IC102. Insert R108 and R107 first, then solder and clip the

moment and check your work. There should be spaces left for C104 and C103. Continue by moving to the right and installing a 47-ohm resistor at R118. On the other side of IC103, install a 10K unit at R116. Move down and install a 2.2K resistor at R117. Keep going by installing the remaining 100K units at R123 and R124. Install 33K resistors at R125 and R126. Then move up slightly and install a 68K unit at R122. Install a 1-meg resistor at R121, next XTAL101. That takes care of the resistor installation, and the board is now taking on a finished appearance.

There are five wire jumpers on this board, and they should be installed

board before soldering.

Next come the transistors. Start with Q101, a 2N3906. Install it as shown next to IC103, with the flat side pointing down. Then install Q102, an MPS-A13, as indicated next to the pot. Be sure to position the case so that the flat spot points to the right. Finish up with the power-supply components. Install IC104, a 78L05 regulator, as shown, next to the crystal. Be sure the flat side of the case is pointing down. Then in-



Synthesized RF Generator

GARY McCLELLAN

This month we'll show you how to assemble the Programma-2's two main boards. When we're done, the RF generator will be nearly complete.

leads. Then install the group of four just below. Start with R104, continue with R105, and R131, and end with R106. Solder each connection and clip the leads. Then move to the right, and install another group of four resistors, beginning with R111, continuing with R110 and R109, and ending with R103. Solder and clip. Finally, move up and install the last group of four resistors in the same manner. Note that this group starts with R115 and ends with R112.

Continue with the rest of the resistors. Refer to Fig. 5 for details. Starting at the top left corner, install 100K resistors at R101 and R102. Then move down below IC102 and install a 100-ohm resistor at R127. Move to the right slightly and install a 150-ohm unit at R120. Keep going right and install 10K resistors at R119 and R129. After that, install a 22K resistor at R130. Stop for a

next. Use leftover resistor leads. The jumpers are identified with a "J" in Fig. 5. Install the first two as shown between IC101 and IC102. Bend the leads to fit with needle-nosed pliers, and insert them into the holes. Make sure they aren't touching, then solder and clip off the excess lead. Install the next jumper near pin 1 of IC102. Move to pin 1 of IC103, and install a jumper just below it. Finally move over to pin 1 of IC105 and install the last jumper.

Now for a few odds and ends. Start by installing C111, a 5-30 pF trimmer, by the crystal. Before installing it, turn it over and identify which pin goes to the adjusting screw. This pin must go the ground foil, and is usually wider than the other pin. Insert the trimmer so that this pin points up, and solder. Then install R128, a 5K pot. Install as shown, being sure to press it flush against the

stall D101, a 1N5229 Zener diode near the right edge of the board. Note that the banded end points toward the center of the board. Stop at that point and double check the installation of the parts. It's a good idea to correct any mistakes before going any farther!

All that's left are the capacitors. They will be installed like the resistors, from left to right in Fig. 5. Start by installing C101, a 0.001 μ F disc above IC101. Then install C108, a 0.1 μ F disc, on the other side of the IC. Keep going and install C104, a 22 μ F tantalum type. Note that the "plus" side faces R120. After that, install 0.1 μ F Mylar capacitors at C102 and C103. Continue by installing C110, a 220 μ F electrolytic. Note that the "plus" side faces the edge of the board. At the other edge, install C105, a 100 μ F electrolytic. Be sure the "plus" side faces the center of

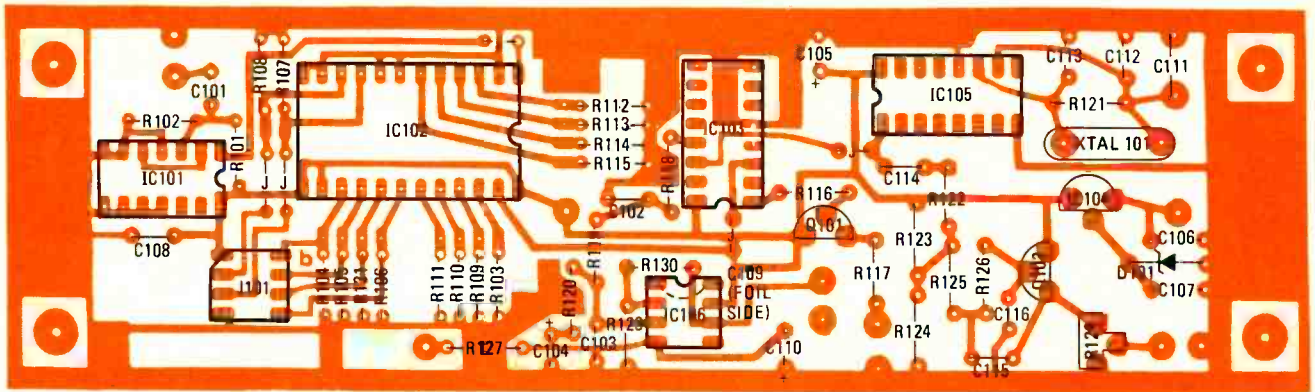

FIG. 5—STEP-BY-STEP assembly instructions are given in the text. Don't forget to install the five jumpers.

the board. Move down and install C114, a 0.1 μF disc next to IC105. Keep going down, and install C115, a 0.1 μF Mylar capacitor near the pot. Then, just above this capacitor, install C116, a 0.001 μF Mylar capacitor. At the top of the board install C113, a 68 pF mica. And right next to it, install C112, a 39 pF mica unit. Finish up by installing two 0.1 μF discs on either side of D101 at C106 and C107.

Stop at that point and check your work. Make sure the capacitors are installed in the proper places, and that the polarized ones are oriented properly. Correct any mistakes before going any farther. The board should look like the one in Fig. 6.

Turn the board over and install C109 (100 pF) on the foil side, between pins 1 and 8 of the IC106 socket. Trim the leads to about 1/4-inch first, then solder



FIG. 6—COMPLETED CONTROL BOARD. Light-colored ribbon cables around 4059 IC go to switches. Dark cables will be added later.

across the pins as shown. Bend the capacitor so that it is flush with the board. This completes the control board.

Switch connections

Now is a good time to connect the FREQUENCY-SET switches to the board, and install the IC's. Those switches, S1-S4, are the ones that mount on the front of the instrument and program the desired frequency. All wiring is done around IC102.

Refer to Figs. 7 and 8 for details as you wire the switches. It is suggested that you use short lengths of 4 conductor cable for the connections; this makes the wiring easier to follow and less messy.

The first step is to prepare the cables. Prepare four six-inch strips. Then remove two conductors from one of the

strips. Separate the ends of all cables for at least 1/2-inch, then strip and tin the ends. Also cut a 6-inch piece of hookup wire and strip and tin its ends. Now you are all set for the wiring.

Look carefully at your switches' ter-

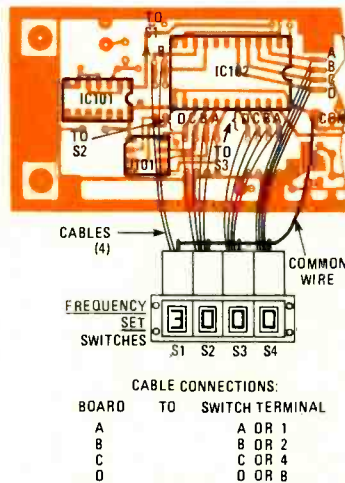

FIG. 7—DETAILS of board/switch connections. They're not difficult—just match up the letters.

minals. They should be marked: "C, 1, 2, 4, 8," "COM, A, B, C, D," or similarly. Run a piece of bare wire through all the "COM" lugs and solder at each. Then solder one end of the single piece of hookup wire to one of the common lugs. Now turn to the front of the switches, positioning them so you can read them. The switch position to the farthest left is S1. Connect the two-conductor cable to the "A" and

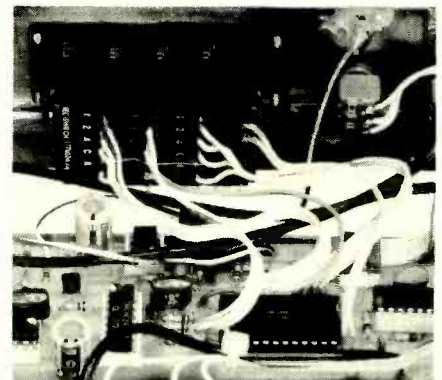

FIG. 8—SWITCHES AND CONTROL BOARD mounted in case. Usefulness of ribbon cable is obvious.

PARTS LIST CONTROL BOARD

All resistors 1/4 watt, 5%, unless otherwise noted.

R101-R115, R123, R124, R131—100,000 ohms

R116, R119—10,000 ohms

R117—2200 ohms

R118—47 ohms*

R120—150 ohms*

R121—1 megohm

R122—68,000 ohms

R125, R126—33,000 ohms

R127—100 ohms

R128—5,000 ohms, trimmer potentiometer, horizontal PC-mount

Capacitors

C101—0.001 F, ceramic disc

C102, C103, C114, C115—0.1 F, 50 volts, Mylar*

C104—22 F, 16 volts, tantalum*

C105—100 F, electrolytic, 16 volts

C106-C108—0.1 F, 16 volts, ceramic disc

C109—100 pF, ceramic disc

C110—220 F, 6.3 volts, electrolytic

C111—5-35 pF trimmer (E.F. Johnson 275-0430-005 or equivalent)

C112—39 pF, mica

C113—68 pF, mica

C116—0.001 F, 50 volts, Mylar

Semiconductors

IC101—CD4013 dual D flip-flop with set/reset

IC102—CD4059 programmable divide-by-n counter

IC103—CD4046 phase-locked loop

IC104—78L05 five-volt, 100 mA, regulator

IC105—CD4060 14-stage rippled counter

IC106—CA3130AE op amp (RCA)

Q101—2N3906 PNP

Q102—MPS-A13 Darlington, NPN

D101—1N5229 4.3-volts, 500 mW, Zener diode

XTAL101—2.048 MHz, 32 pF parallel-mode, $\pm 0.005\%$, HC-33/U case

S1-S4—BCD thumbwheel switch (C&K 332110000 or equivalent)

J101—8 pin IC socket

Miscellaneous: PC board, IC sockets, 4-conductor ribbon cable, wire, solder, etc.

“B” (or “1” and “2”) lugs. The switch section next to S1 is S2. Solder the wires from a four-conductor cable to each of its terminals. If possible, match the colors to those used on S1 (and do the same for the other sections). It's easier to connect a switch, if, say, all “A” leads are green, “B” leads are blue, and so on. Wire up S3 and S4 in the same manner.

Finish up by connecting the switches to the board. Start by inserting the wire from the switches' common bus into the COM pad on the board. Solder it in place. Then match up the leads from S1 to the “B” and “A” holes below R107 and R108 on the board. Insert and solder. Match up the leads from S2 with the points on the board above the resistor group starting with R104. Note that the connections are “DCBA” reading from left to right. Insert and solder. Likewise, insert and solder the leads from S3 into the holes above the resistor group starting with R111. Note that the connections are arranged as

“DCBA” like those for S2. Finally, insert the wires from S1 through the holes by the resistor group starting with R112. Note that R112 is the “A” connection, and that the others follow in order. That ends the switch installation.

Check over your wiring for errors, and correct any mistakes. Then finish up by installing the IC's. Refer back to Fig. 5 for placement. Install a CD4013 at IC101, a CD4059 at IC102, and a CD4046 at IC103. Make sure they are plugged in properly (watch out for bent pins) and then install a CD4060 at IC105 and a CA3130 at IC106.

That completes the control board. Next we'll cover the VCO board and start discussing final assembly.

How the VCO works

The VCO board contains three oscillators, a divider, a modulator, and an RF amplifier. Also included is some switching circuitry for both RF signals and power, and two power supplies. At this point you may want to refer to the

schematic in Fig. 9 as you read about the circuitry.

The oscillators consist of IC201 through IC203, Motorola MC1648's, together with a few external components. The 10–30 MHz signals are generated by IC201, while IC202 generates the 5–10 MHz signals and IC203 handles the 3–5 MHz range. Tuning within these ranges is done by D201 through D203, Motorola MV1404 tuning diodes. Think of them as electrically controlled variable capacitors; an input voltage ranging from 0.5-volt to 9-volts will cause each oscillator to tune through its frequency range.

Since only one oscillator at a time can be operating in this device, some switching has to be done. Transistors Q204 through Q206 perform this task. The desired oscillator is turned on by grounding the base one of the transistors. This is done by the switch board, which will be described later.

The outputs of the oscillators are ECL-level (0.8 volt AC), but transistors

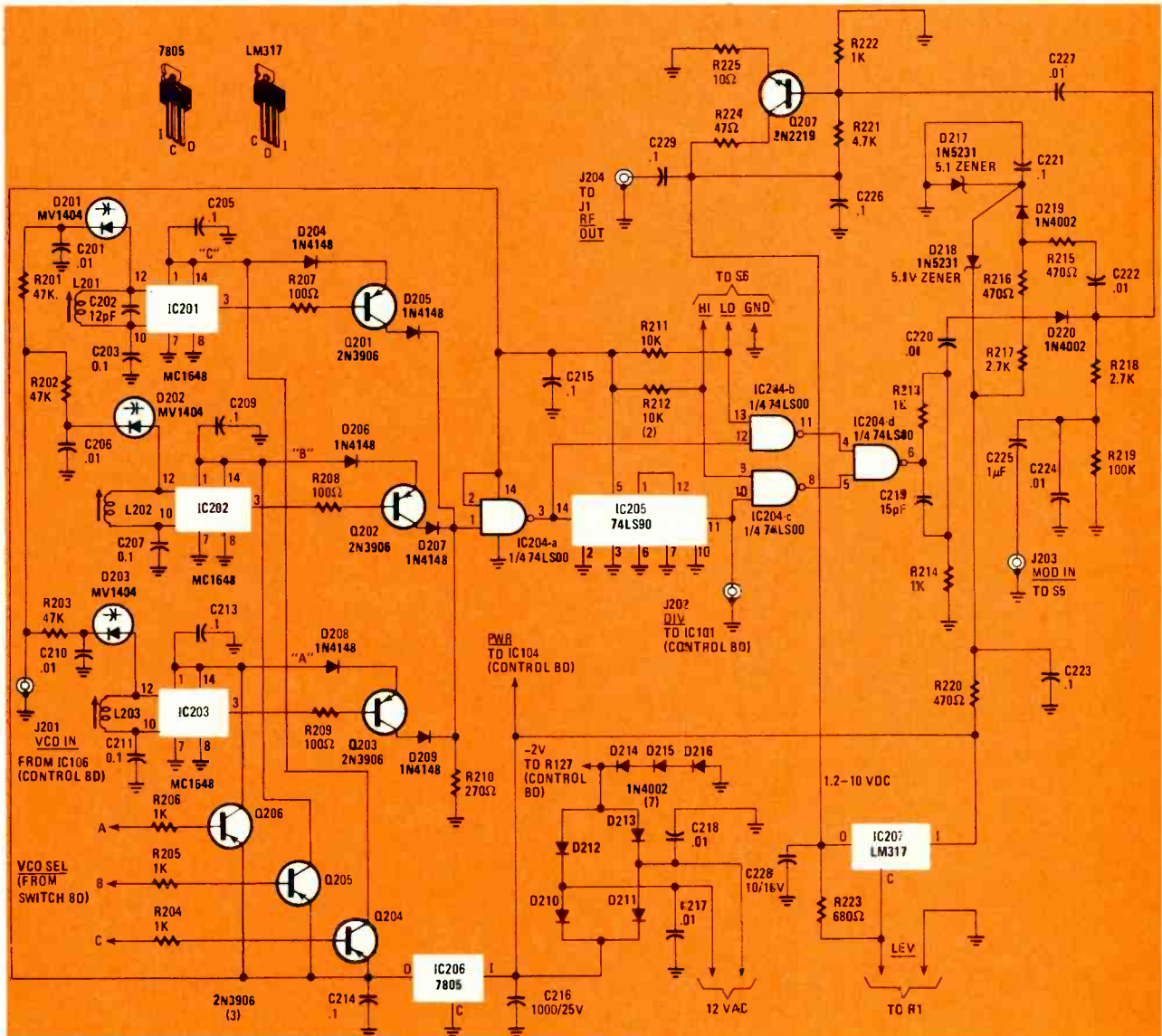

FIG. 9—THE PROGRAMMA-2 uses an ingenious method for controlling modulation and RF-out-put levels—the heart of the circuit is at diodes D219 and D220 (upper right). The scheme is described in the text.

Q201 through Q203 increase those signals to TTL levels for use by the circuitry that follows. The diodes are included for biasing and switching. Finally, IC204-a is used to buffer the signal, insuring that it is at TTL levels.

The VCO signal from the buffer is fed to both IC205, a divide-by-10 counter, and to IC204-b. That gate, together with IC204-c and IC204-d, act as an SPDT switch and select either the "direct" VCO signal or the divided-down signal from IC205. This solid-state switch is controlled by the HI/LO switch, S6, on the front panel. When the HI line from the switch is grounded, the VCO signal feeds straight through over a range of 3 to 30 MHz. When the LO line is grounded, the divided-down signal is selected (300 kHz to 3MHz). This eliminates the need for extra VCO's. The output of the divider also goes to the DIV jack, J202, which provides the signal required for the control board's programmable-divider circuit.

The output of IC204 drives the modulator circuit. This circuit is unusual in that it uses diodes to modulate the VCO signal. Basically, it is nothing more than a voltage controlled attenuator. The amount of signal passing through it depends upon the control voltage, which is really the sine wave from the MOD IN jack. Resistor R219 sets the bias so that the signal will continue to pass through the circuit when there is no modulation.

In operation, diodes D219 and D220 are forward biased, although to different degrees. Diode D220 tends to be more heavily biased because there is less resistance between it and the power source. At the cathode end of this diode there are several resistors. The 500-Hz modulation is also applied at this point, and the voltage across the

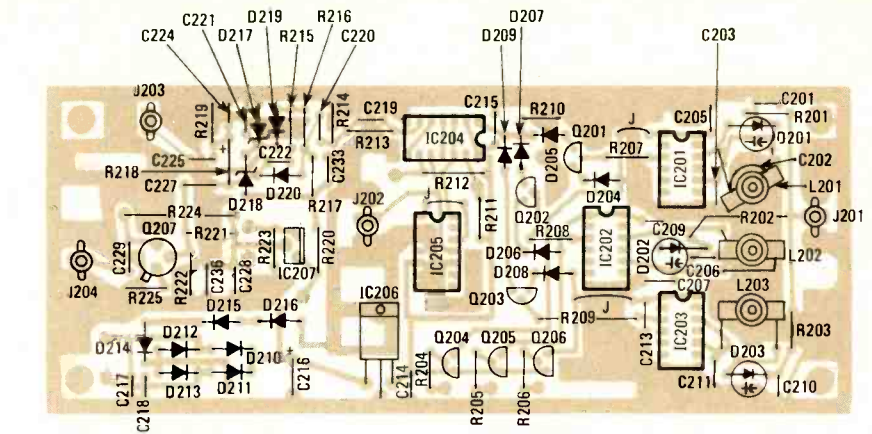

FIG. 11—CONNECTORS FROM THE COILS to the board are made using leftover capacitor leads. Capacitor C202 is soldered directly to the lugs of coil L201.

resistors causes the current flow through the diode to vary. As the current through D220 varies, it can be greater or less than the current through D219.

At this point an interesting characteristic of diodes enters the picture—diodes can act as variable resistors; the greater the current flow through a diode, the more signal it will pass. Sometimes D219 conducts more signal—to ground, and sometimes D220 conducts more signal—to the RF amplifier. This circuit is known as a *T attenuator*. In the Programma-2 it causes the level of the RF signal to be controlled by the level of the 500-Hz tone.

From the modulator the signal goes to a broadband RF amplifier, which boosts it to useful levels. This is the job of Q207, which has a maximum gain of 5. The output level is controlled by adjusting the power supply voltage—in this case from 1.2 to 10 volts. This supplies from 10 mV to over 300 mV of signal at the RF OUT connector.

The rest of the circuitry on this board consists of power supplies. There is the usual 5-volt regulated source for the ECL and TTL devices, plus an adjustable source for the RF amplifier. An LM317-T adjustable regulator handles the latter job.

Construction

A foil pattern for the VCO board is provided in Fig. 10. If you prefer not to make your own, refer to the Parts List for a supplier.

Start construction by studying Fig. 11. To simplify matters, we'll break the board into two sections and concentrate on completing each separately; this makes construction a lot easier.

The first thing to do is to enlarge the holes for coils L201-L203. Using the IC pads as a guide, orient the board as shown in Fig. 11 and locate the three holes. Note that they are part of the ground foil that runs around the edges of the board. Using a set of progressively larger drills, increase the size of the

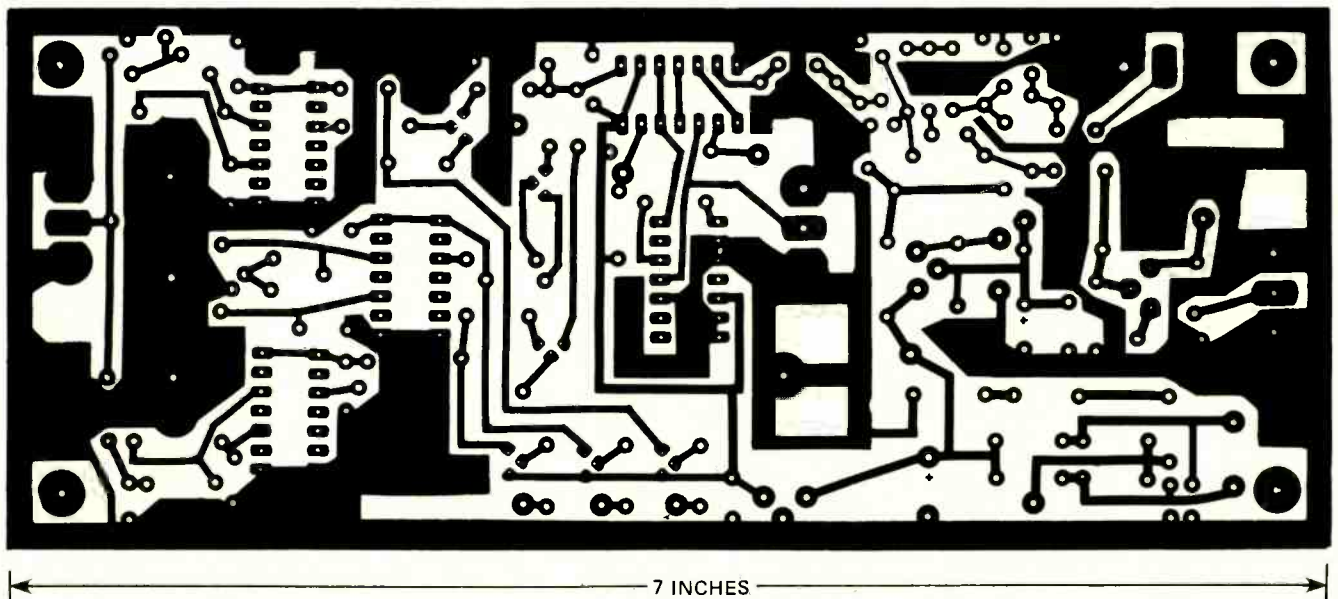

FIG. 10—THE COMPLEX VCO circuit can be built on a single-sided PC board using only three jumpers.

PARTS LIST

VCO BOARD

All resistors ¼-watt, 5% unless otherwise specified

R201-R203—47,000 ohms

R204-R206, R213, R214, R222—1000 ohms

R207-R209—100 ohms

R210—270 ohms

R211, R212—10,000 ohms

R215, R216, R220—470 ohms

R217, R218—2700 ohms

R219—100,000 ohms

R221—4700 ohms

R223—680 ohms

R224—47 ohms, 2 watts, carbon composition (see text)

R225—10 ohms

Capacitors

C201, C206, C210, C217, C218, C220, C222, C224, C227—0.01 μ F, 16 volts, ceramic disc

C202—12 pF, ceramic disc or mica

C203, C205, C207, C209, C211, C213-

C215, C221, C223, C226, C229—0.1 μ F, 16 volts, ceramic disc

C204, C208, C212—not used

C216—1000 μ F, 25 volts, PC-mount electrolytic

C219—15 pF, ceramic disc

C225—1 μ F, 16 volts, electrolytic

C228—10 μ F, 16 volts, electrolytic

Semiconductors

IC201-IC203—MC1648P MECL voltage-controlled oscillator (Motorola)

IC204—74LS00 quad NAND gate

IC205—74LS90 decade counter

IC206—7805 or LM340-T 5-volt regulator, TO-220 case

IC207—LM317-T adjustable voltage regulator, TO-220 case

Q201-Q206—2N3906 or equivalent

Q207—2N2219 or equivalent

D201-D203—MV1404 tuning diode (Motorola)

D204-D209—1N4148 or 1N914

D210-D216, D219, D220—1N4002, 100 PIV, 1 amp

D217, D218—1N5231 Zener, 5.1-volts, 500 mA

L201—0.3-0.58 μ H coil (Miller 4201 or equivalent)

L202—2-5.5 μ H coil (Miller 4203 or equivalent)

L203—10-25 μ H coil (Miller 4205 or equivalent)

J201-J204—PC-mount RCA-type phono jacks

Miscellaneous: PC board, IC sockets, slip-on TO-5 heat sink for Q207, solder, etc.

A complete set of three boards for the **Programma-2** is available for \$22.00 ppd. from: **Technico Services, PO Box 20HC, Orangehurst, Fullerton, CA 92633. CA residents please add 6% tax; foreign orders please add \$3.00 for shipping. Order No. SSG-1.**

A complete set of **parts, excluding boards, crystal, transformer and case**, is available for \$112.00 ppd. from: **Circuit Specialists, Inc., PO Box 3047, Scottsdale, AZ 85281. Order No. KT-5. Phone orders (800) 528-1417; all other inquiries (602) 996-0764. AZ residents please add tax.**

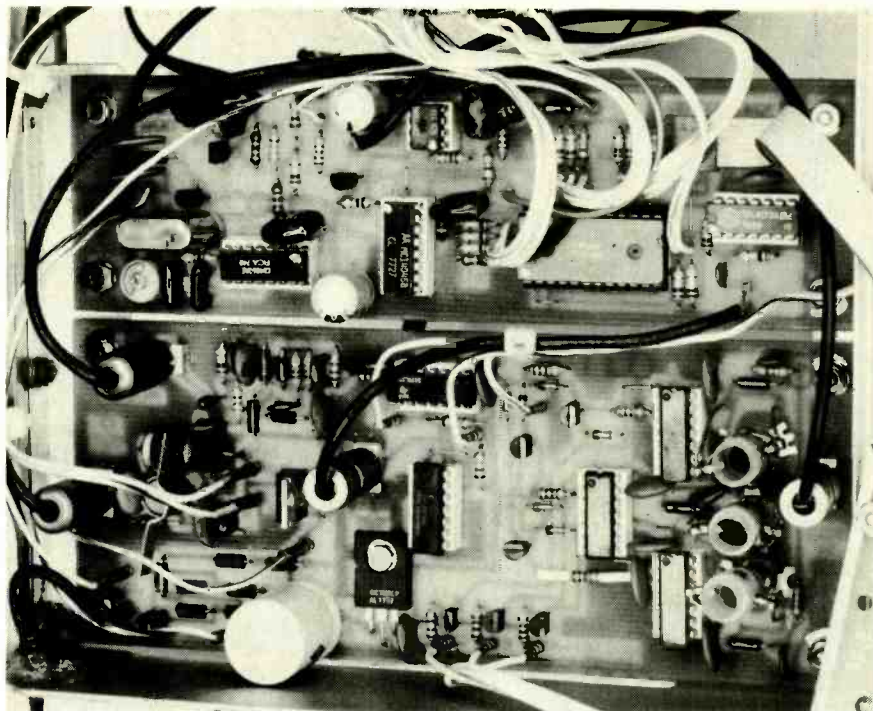

THIS IS WHAT THE VCO BOARD looks like when it is finished and mounted in the case. The board below the VCO board is the control board.

holes to ¼-inch. Then use a reamer or small file to enlarge them farther, to ⅜ inch.

Next, install the IC sockets. Note that there are five of them, and that they are all 14-pin units. If the sockets have an identifying mark for pin 1, position them as shown.

The four RCA jacks, J201–J204, are installed next. You may have to enlarge the holes in the board so that they can be mounted.

Install the capacitors as shown. Begin with the 0.01- μ F discs, and install one each at C201, C206, and C210. Note that these parts are located near the coils. Then continue with the 0.1- μ F capacitors. There are quite a few. Install one at C205, C203, C209, C207, C213, and C211. Then move to the top left corner of the board and install one at C215. Move down and install one at C214. That almost takes care of the capacitors: there's one left to mount on a coil.

The coils are next. They just snap into place. Be sure to observe the positioning of the terminals before you snap them in place; this is important. Install the No. 4201 coil at L201, the No. 4203 coil at L202, and finally, the No. 4205 coil at L203. Wire the coils to the two pads below them as shown, using short lengths of solid wire. The clipped leads from the capacitors should work fine. Be sure to keep the leads as short as possible; that makes the coils more shock resistant. After the wiring is done, install a 12 pF capacitor, C202, directly across the terminals of L201.

The resistors come next. Install the 47K units first, with one at R201, R202,

and R203. Note that you'll have to bend the leads of R202 so that they don't touch the coil wire. The 100-ohm units are next. Install one at R207, R208, and R209. Be careful to get them in the right places. Then come the 10K units by IC204. Install one at R211 and another at R212. After that come the 1K resistors. Install one at R204, R205, and R206 near the bottom of the board. Finish up by installing a 270-ohm resistor at R210.

The three jumpers go near IC201, above IC205, and next to IC203. Use leftover leads from the resistors for the jumpers. Install the jumper next to IC201 first, then the one below IC202, and last, the jumper above IC205.

Now for the diodes. Note that there are two kinds—MV1404 and 1N4148. The MV1404's come first. Be careful when you install them because they are rather expensive! Avoid bending the leads right at the body as this will break them. Install three MV1404 diodes at D201, D202, and D203 as shown. Note that the banded ends point to the right. Then come the 1N4148's. Install them at D205, D207, and D209 near R210. Then install the rest at D204, D206, and D208. Be sure to check your installation before going farther.

Continue with the transistors. They are all 2N3906's, which makes installation easier. Install one at Q201 and Q202. Be sure the flat in the case points to the right. Then do Q203 with the flat side pointing up. When done, move down and install the three remaining transistors at Q204, Q205, and Q206, with the flat side facing right.

continued on page 97

USEFUL TROUBLESHOOTING HINTS & TIPS

The best solution to any problem is often the simplest one. Here are some easy-to-use ideas that really work.

ELLIOT S. KANTER

A SHORT TIME AGO, I RECEIVED A CALL from a sales engineer who I'd helped before with certain technical problems. This time he had a serious problem that demanded an immediate resolution, as human lives hung in the balance. It seemed that around four in the afternoon each day, the telemetry units in his hospital's coronary-care unit were "clobbered" by brief but overpowering interference.

As you might suspect, the tiny radio transmitters (Fig. 1) that were attached to the patients are low-power (power output is about 1 microwatt) and they transmit in the VHF portion of the radio spectrum. Not being able to drive the 150 miles or so to the hospital, I reasoned that there was a pattern (i.e. specific time each day) and that only the telemetry equipment was being interfered with. About a week or so before, I had posed a question to my class of BMET's (*Biomedical Equipment Technicians*), that asked them to determine a harmonic relationship between a CB transmitter and patient telemetry, and if a harmonic relationship could be identified, what specific telemetry frequencies (there are about eighty) would be affected.

I pulled out my list of calculations, and determined that the telemetry-transmitter frequency was the same as the seventh harmonic of a CB frequency. A quick call to the engineer with the suggestion that he take a walk around the area immediately surrounding the hospital resulted in both identification of the source and a cure. It appears that a nearby citizen was operating an illegal linear amplifier or "kicker." After a few words of explanation, he disconnected the linear and the interference was gone.

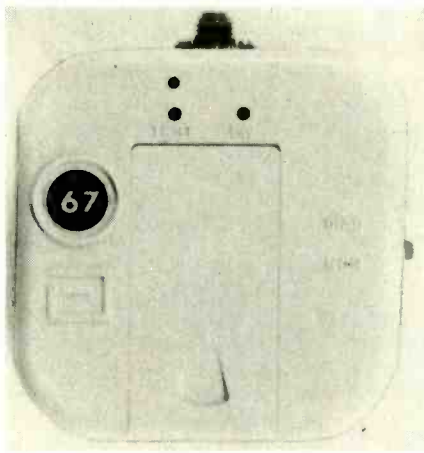

FIG. 1—MEDICAL-TELEMETRY transmitter. Some of those transmitters have power outputs on the order of a microwatt and a range of about 250 feet.

Naturally, the majority of CB users do not operate illegally, but if you do come across a problem like that one, why not stop a minute and determine what frequencies *could* (not necessarily would) have a harmonic relationship that might cause problems. Remember, it is not the properly-operated RF source that will cause the problem, but rather one improperly used or adjusted that can frequently be at the root of a problem.

Staying with low-powered RF sources for a while longer, I found that I needed an easy and cheap method of being certain that one of those small telemetry transmitters was really putting out RF. Again, I was faced with the fact that one particular model didn't even put out a full microwatt, and a frequency counter was a clear case of over-kill. What did evolve is shown in Fig. 2, a simple, cheap, and easy-to-build RF sniffer, in a shielded metal case.

If you are an "old-timer," you will recall the circuit as an add-on RF probe for use with a VTVM. It can be used with digital voltmeters as well. If you deal with devices like medical telemetry equipment, you might want to replace the probe and ground leads with either plugs or jacks to match the input (which is also the output) of the telemetry transmitter. Shielded cable is a must (RG-58/U or RG-174/U) from the probe to the VTVM. The device detects RF and displays it as a DC voltage. While that will not give you a calibrated indication of the power output, it will show you when RF output is there.

PC board component replacement

Usually, changing a resistor, capacitor, or diode on a PC board isn't too difficult or time consuming. All you have to do is unsolder the old part, re-

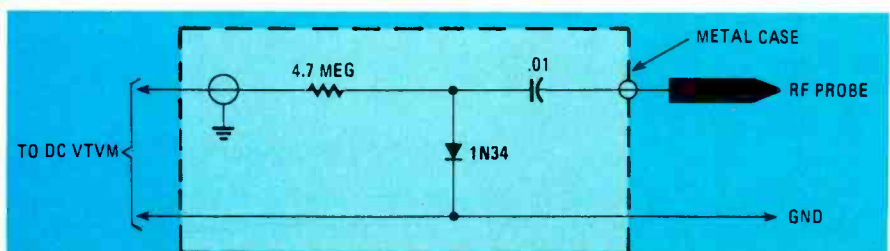
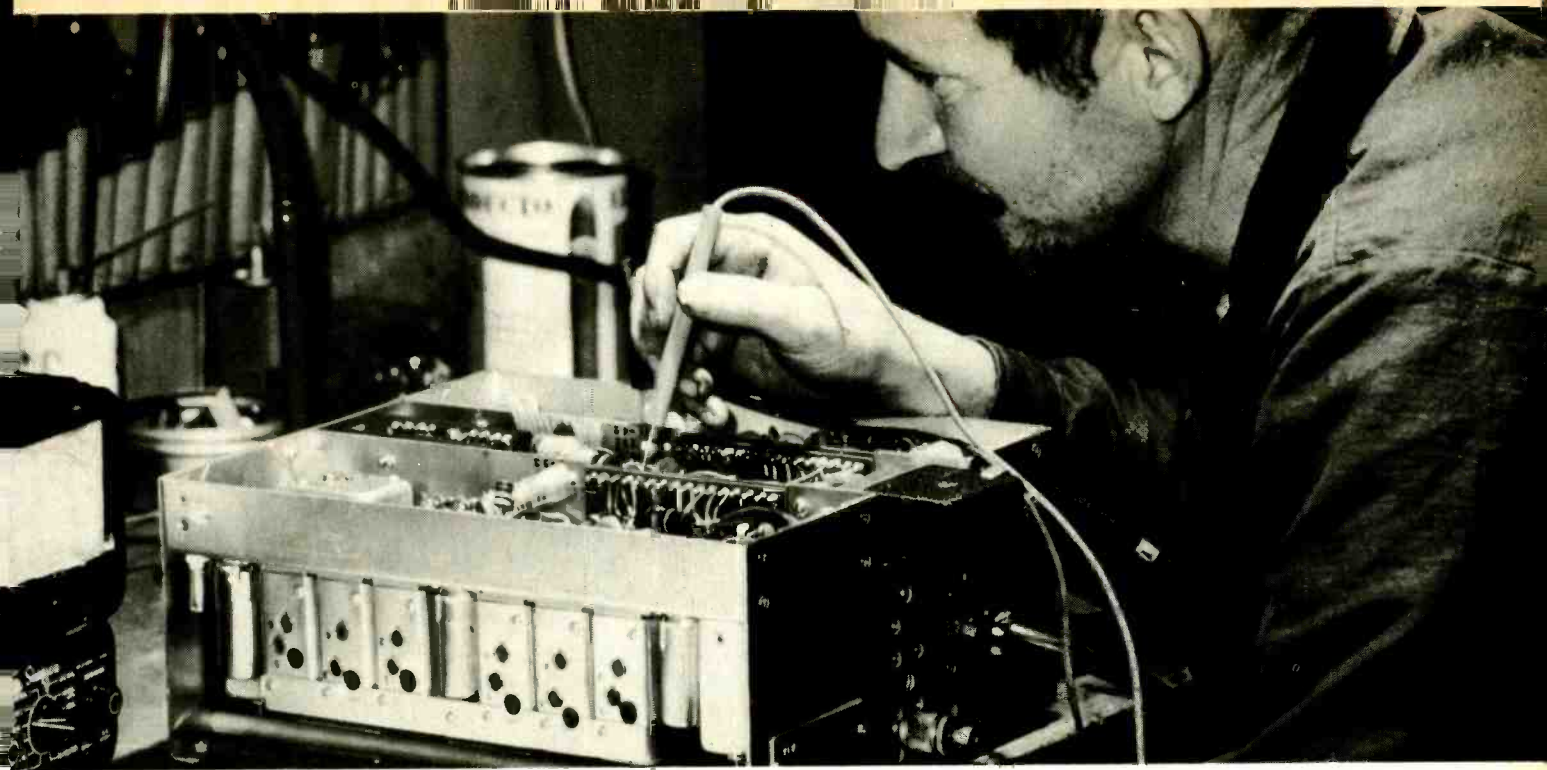

FIG. 2—THIS simple RF sniffer can also be used with a digital voltmeter.



move it, make certain the PC board holes are clear, insert the new component, resolder and clip off the excess leads. I know you are saying that's nothing new and, in fact, those five steps are just what you always do... right? **WRONG!**

Consider a service request I had from a client: She (the head nurse) wanted all twenty of her heart-rate alarms modified for a longer delay before going off in the high-rate mode. That meant that I would have to alter a time constant determined by a resistor and capacitor on each of twenty modules. It was obvious that it would be simpler to change the 22K resistor to 39K than to match a capacitor, but I didn't especially relish all of that soldering and unsoldering. Hence the five-easy-step method illustrated in Fig. 3.

1. Take long-nose pliers and crush the resistor (or diode or capacitor). You might also need side cutters to do the job, but the object is to destroy the component, leaving only the leads.

2. Clean off the wires, and blow or brush away any residue from step one from the PC board.

3. Use your long-nose pliers and bend both of the leads upward so that they will form two posts.

4. Make a loop in each end of the replacement component (I did that before I arrived on site) and slip the replacement component over the two posts prepared in step three. Be sure to observe polarity indications.

5. Solder both connections.

Since you can pre-form the replacement components, you have cut your work at least in half and besides, you have done a neat, professional job without risking heat damage to the PC board traces, which is more than I can

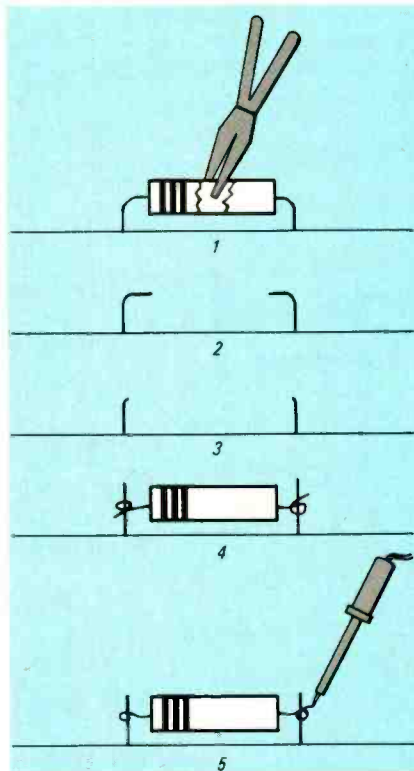

FIG. 3—FOLLOWING these five steps when you replace components on a PC board will result in less work and a neater job.

say for the conventional (still five steps) method of replacing components. Just be sure that you use a well-tinned iron and only enough heat and solder to do the job right.

Versatile heat sink

Like most hobbyists and technicians, I build some equipment myself, either from scratch or in kit form. No matter how careful you are, that old demon—Murphy, of Murphy's Law—tends to

rear his ugly head and make junk out of what should have been a lovely, neat project. Most problems seem to be heat-related and take place while following the instructions that state: "Flip the board full of components over and solder each connection."

While modern components are a great deal less heat sensitive than older transistors such as CK722's heat can, and often does, alter specifications. Besides, there nothing as upsetting as a fully loaded PC board sliding across the table top as you try to solder.

The solution is to locate an ordinary kitchen sponge slightly larger than the PC board in question. You can throw caution to the wind and purchase one or more sponges at your local hardware or discount store. For less than two dollars, you should be able to acquire a collection of assorted man-made sponges which, when damp, will serve two distinct purposes. First, they will act as a slip-resistant PC board holder and second, they will function as a heatsink. If you are a non-believer, the first sizzle you hear while soldering will make a "true-believer" out of you. A bonus is that the PC board is elevated slightly for better access. That hissing will warn you that things are getting hot and will prevent component values from "shifting" due to excessive heating.

Iron idler

There's nothing quite so frustrating as having to wait for your soldering iron to heat up from a dead start. Well, maybe there is something equally frustrating—replacing tips that have been rendered "inoperative" due to overheating. You might suggest the use of a soldering gun but remember, very few

continued on page 101

STATE OF SOLID STATE

From keypad to display using IC's

JOSEPH GARTMAN AND ROBERT FALKNER

LET'S TAKE A LOOK AT TWO EXCITING digital IC's from National Semiconductor; The MM74C922 16-key encoder that outputs binary code from a 4 × 4 row-column matrix of switches, and the MM74C912, a 6-digit BCD-display decoder/driver that does all the house-keeping for a 6-digit by 7-segment-plus-decimal-point display.

The MM74C922 encoder scans columns in a 4 × 4 16-key keyboard with a 2-bit counter and then reads out rows with a 4-line 2-bit encoder. A single capacitor completes the on-chip clock circuit, or an external clock can be used. When the 2-bit column clock counter, which is decoded to four dis-

crete lines, scores a "hit" in the row encoder, a key-detect plus is sent through an on-board key-bounce eliminator and provides a strobe for the data available pin. It also latches the 4-bits (2 from the counter, 2 from the row encoding logic) of BCD data near the output. These latches are followed by on-chip Tri-state buffers that can disable or enable the data-output lines. The row encoding logic also incorporates a two-key rollover.

The MM74C912 decoder/driver accepts a 4-bit binary input (plus a decimal-point control line) and a 3-bit address, plus write enable, chip enable, and two output and multiplex-scan

oscillator-enable control lines. The 3-bit digit address loads the appropriate latch of six 5-bit latches with the BCD-plus-decimal-point data strobed into the IC. An on-chip oscillator (requiring only an external capacitor) drives a count-to-6 counter. This both selects the digit that is being driven by the digit driver and multiplexes the appropriate latch's 4 data bits (the decimal point is driven separately with its own line) into a 16-line by 7-bit ROM. The ROM outputs segment information (and the decimal-point control line) to an array of NPN segment drivers that can typically output 80 mA. And, according to Na-

continued on page 93

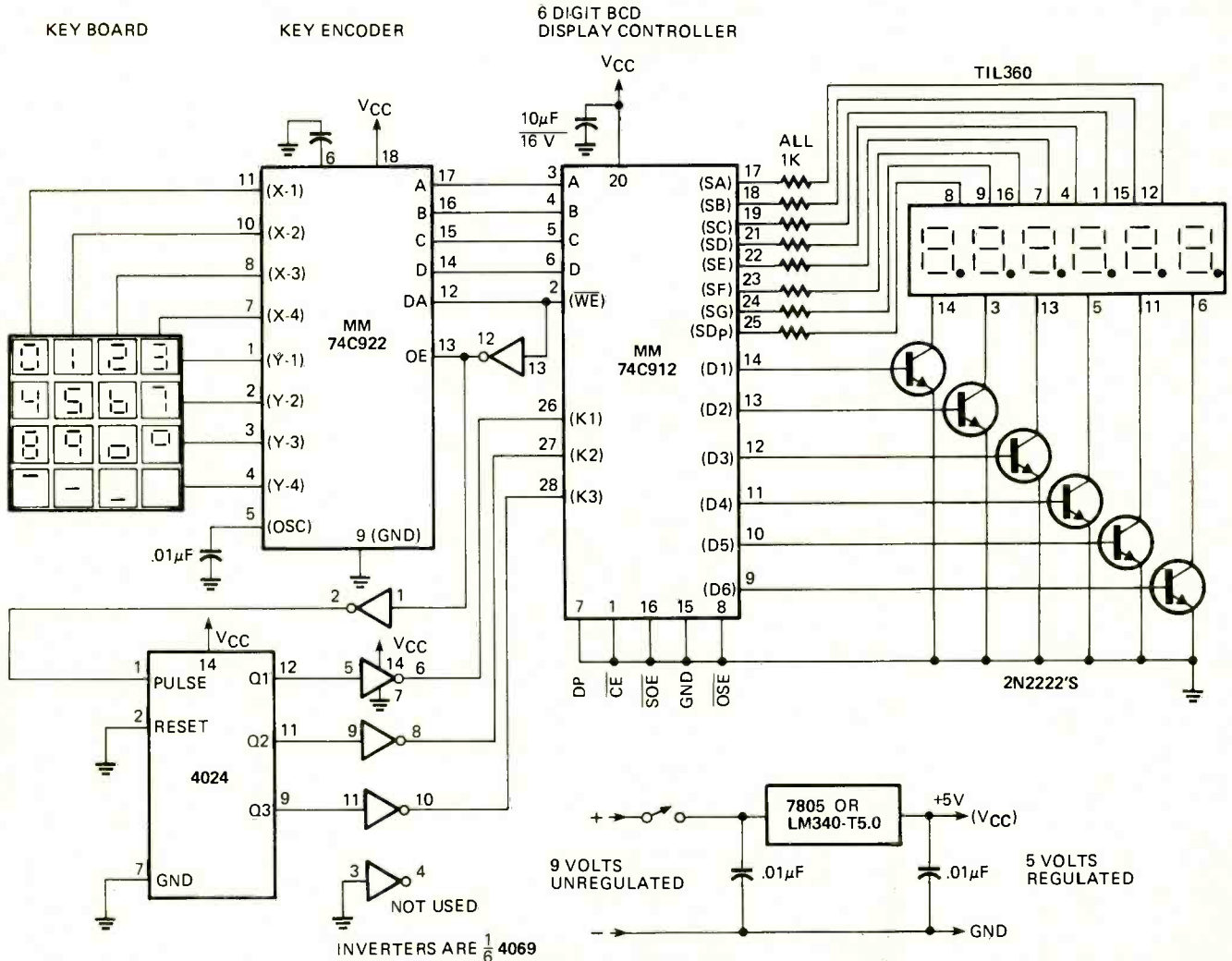

FIG. 1—THE KEYBOARD/DISPLAY circuit displays inputs from the keyboard on the 6-digit LED readout.

Look no further! One of these nine SIMPSON DMMS is right for you!

Now there are nine value-engineered Simpson DMMs from which to choose... with the performance and features you really need!

Each one is a best design for hands-free measurements on the bench or in the field. Engineered for reliable service by the maker of the world famous 260[®] VOM.

Built to last with quality-selected components, built-in protection systems and high-impact cases.

Every Simpson DMM is given a double burn-in, and is backed by Simpson's one-year warranty.

The New Model 467 hand-portable DMM introduces the new exclusive Digalog™ Display LCD digital and analog readout. Additional unique features include differential peak hold, pulse detection, visual/audible continuity and logic level indication, true RMS measurement.

Other value-priced Simpson compact DMMs give you a choice of LED or LCD displays, autoranging and even more wanted features.

Our bench DMMs offer large, bright LED displays, and a choice of extra features such as AC or battery operation, 10-amp AC current range, auxiliary analog meter, autoranging.



Autoranging
Bench Model 465-2A \$384*

Deluxe Digital/Analog 460-4A
\$360*

EACH OF THESE EIGHT SIMPSON DMMs IS LISTED!



They each meet the requirements of UL 1244 Standard for Safety of Electrical and Electronic Measuring and Testing Equipment... and also meet ANSI C39.5.



Bench Model 464-2A
\$276*

NEW!
True RMS
Model 461-2R
\$223

Autoranging
Model 462
\$232



NEW!
Model 461-2
\$185



NEW!
Digalog™ Display
Model 467 \$245

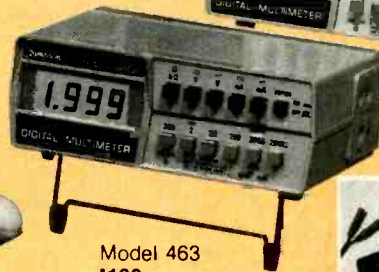

Model 463
\$190



A full line of accessories expands the measuring capabilities of your Simpson DMM.

SEE THEM ALL AT YOUR LOCAL ELECTRONICS OR ELECTRICAL DISTRIBUTOR... OR WRITE FOR A FREE CATALOG.



SIMPSON ELECTRIC COMPANY

853 Dundee Avenue, Elgin, Illinois 60120
(312) 697-2260 • Telex 72-2416 • Cable SIMELCO
IN CANADA: Bach-Simpson, Ltd., London, Ontario
IN ENGLAND: Bach-Simpson (U.K.) Ltd., Wadebridge, Cornwall
IN INDIA: Ruttonsha-Simpson Private, Ltd., Bombay

* Price for AC version. AC/rechargeable battery version available at extra cost.

KATY INDUSTRIES



ELECTRICAL EQUIPMENT AND PRODUCTS GROUP



And there's also the popular 360[®] Digital VOM... image mate to the world famous 260[®] VOM.
\$350

CIRCLE 13 ON FREE INFORMATION CARD

HOBBY CORNER

An easy way to etch one-of-a-kind PC boards without a darkroom

EARL "DOC" SAVAGE, K4SDS, HOBBY EDITOR

WE HAVE ON SEVERAL OCCASIONS DISCUSSED the various methods of making printed circuit boards, especially those methods that are most suitable when you need only one or two of a given board. You are aware of my inclination to avoid the etching process, which I have always considered to be time consuming and messy.

Not long ago I told you about Bishop's copper stick-on patterns that produce a good board with no etching. Some of you have written to say that you don't mind etching all that much but inquired about how you could avoid using a darkroom.

Well, to each his own. (Wouldn't it be a boring world if we were all alike!) Here is some information for you no-darkroom etchers. This method and the associated products are from DATAK Corp. (Box 192, Sparks, NV 89431 or 65 71st Street, Guttenberg, NJ 07093).

You may be familiar with Datak's panel and equipment marking sets. Those rub-on letters, numbers, titles, and symbols have been available for years. The really neat and professional looking projects you see in *Radio-Electronics* were probably marked with Datak materials.

Their *Direct Etch* dry-transfer system consists of the standard PC patterns mounted on plastic sheets. Those sheets appear very much like black patterns made for photographic reproduction by Datak and other manufacturers but there is a significant difference. The photo patterns are printed with ink and the *Direct Etch* patterns are made of black plastic. The *Direct Etch* sheets are very clearly marked with the words ETCH RESISTANT.

In use, the *Direct Etch* dry transfer patterns are simply rubbed on copper clad boards. To insure sharp etching without undercutting, the patterns should be burnished down. When the circuit pattern is in place, as shown in Fig. 1, you are ready to etch. A clean copper board, adequate burnishing, and proper etching will assure you of a good PC board.

When the etching is completed, completely remove the *Direct Etch* material. A PC board with the *Direct Etch* partially removed is shown in Fig. 2. A finished, ready-to-drill board is shown in Fig. 3.

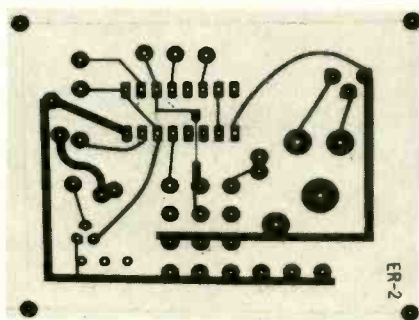

FIG. 1

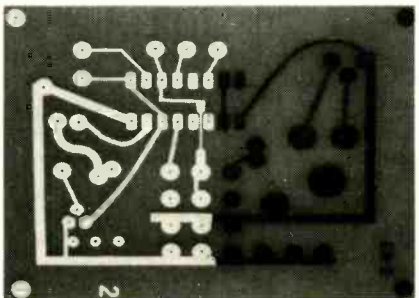

FIG. 2

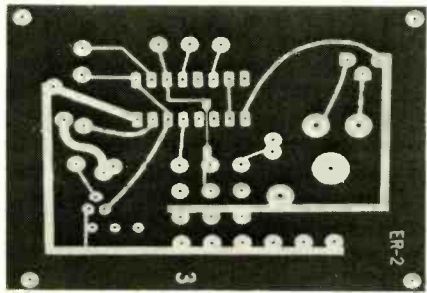

FIG. 3

That's all there is to the system. There are advantages and disadvantages, just as there are to other systems we have discussed. You should select the system you prefer, and the one that best meets your needs.

Datak *Direct Etch* dry transfer materials, including complete kits, are available through your local dealer. Either Datak office should be able to furnish you with information on that product as well as their others.

Do unto others

Just the other day I received a copy of a letter from a "Hobby Corner" reader. The original had been sent to a re-

spected, long-established national company. It seems that this reader had ordered an item that had been mentioned in this column but he did not receive it. He did enclose a photo-copy of his cancelled check.

Now I know that there are some crooks out there in the mail-order business. But they are a very small minority and most don't stay in business very long once word gets out.

Most people that you deal with through the mail are quite honest and they do their best to serve you well. Yet, I can think of a number of reasons why they may fail to get ordered merchandise to you.

For example, they may have done their part but the carrier failed to deliver. I have had even first class mail and packages misdelivered, and on occasion lost by the US Postal Service. If that happens to first class mail, how much more frequently must it happen to third and fourth class packages?

Another reason for not receiving merchandise may be honest error. Of course, the reputable firms attempt to keep the number of errors to a minimum but one will creep in now and again. (I don't know of any organization or individual who is perfect!) It does happen sometimes that an order gets marked "Filled" when it hasn't been. Occasionally a wrong address gets placed on a label. And sometimes some very strange things happen—about two weeks ago I received a sturdily wrapped empty box!

Getting back to the reader's letter, I regret that *Radio-Electronics* and my name were mentioned in it. The writer was abusive and accused the company of dishonesty. That's not the way to go about getting a mistake corrected! If you write such a letter, you should not expect the seller to be in a big hurry to solve your problem.

When you do not receive an order, keep your cool. Let the seller know and give him a chance to correct the error whether it was his or the carrier's. Give him the benefit of the doubt—do not jump to the conclusion that he is trying to cheat you.

Of course, you deserve the merchandise that you've paid for. If you don't receive it after a reasonable notification and in a reasonable time, complain to

the postal service and to the state and federal consumer protection offices. And write our advertising department in New York City, giving full details. They usually can get results.

I should also mention that you should allow ample time for your order to be filled. All kinds of things can prevent a company from getting your order out within a day or two of its receipt—illness, holidays, trouble with their suppliers, and so on. (They are required to notify you if it will take more than 30 days.) Recently I mailed a small first class package; It took two and a half WEEKS to make the 350-mile trip!

So if you have trouble with an order, remember that the other guy is most likely as concerned as you are and is really trying to serve you well. Start with reasonableness and patience.

Packrat

Perhaps I am unduly influenced by the "Be prepared" motto or perhaps I suffer from the "get-it-while-the-price-is-right" syndrome. For whatever reason, I seem to gravitate toward bargain tables.

Bargain tables are a source of unending delight to me. They may contain almost anything—discontinued merchandise, slow-moving stock, returned kits that someone goofed up—you never know. And I just can't resist. How about a communications receiver that cost \$10 and required that I spend one-half to locate and replace a reversed electrolytic? Or a \$5 two-way telephone amplifier with one cold solder joint?

You get the idea. I have bought hundreds of diodes, resistors, IC's, transistors, capacitors, and so on because "someday I'll need that." And in most cases, I have!

What brought all that to mind is that last week a friend lost a large gold class ring in some tall grass near his home. A diligent search proved useless. He told me a couple of days ago that he had to find a metal detector somewhere. You can imagine my response: "Let's see—I think I have one."

I did! It was a bargain kit that I picked up a couple of years ago after dropping a key that I didn't find until the snow melted. Following a little assembly time, my friend was out trying to locate his ring. He's still out there making sectional sweeps.

Now I'm going to have to get back in that storage closet. I saw some other forgotten bargains in there—an electronic thermometer, three 100-kHz calibrators, and two VOM's. I wonder what else I have packed away in that closet in the last several years.

Theatrical light control

Rod Schmidt of Mascoutah, IL is looking for some help in designing a system to control theatrical lighting in

his school. He needs to control six identical circuits (independently, I assume). Each circuit carries 600 watts on 110-volt lines.

Rod has reviewed the "Hobby Corner" (**Radio Electronics**, December 1977) on SCR's and triacs. He plans to use triacs for full-range control but the final design is a bit more complex.

The dimming system must be operable from backstage and from a remote location at the back of the auditorium. It's also possible to control the triacs with a microprocessor.

I am sure that some of you have encountered lighting problems similar to those Rod is facing. How did you solve them? Let me know and I'll pass the best solution along.

Automotive microprocessor

M. A. Anderson of Julian, CA has written to inquire about the Mostek 3870 IC that is billed as an "8-bit automotive microcomputer." The IC itself is inexpensive but some of the devices using it are quite costly.

Anderson feels that there must be many applications in which a hobbyist can use a 3870. I suspect that he is correct but I have not had a chance to experiment with it myself. The IC contains a programmable timer, a clock, 64 × 8 RAM, 2K PROM, I/O's, and other goodies. That sounds like the makings of a variety of interesting devices.

Let us know if you have used the 3870 as the basis for a project and we'll pass the information along.

Coming soon

I am sure that you have seen ads for the 76477 sound generator IC. It makes some of the best and worst sounds you've ever heard. We'll be looking at a project using the 76477 in the near future. Stick around. R-E

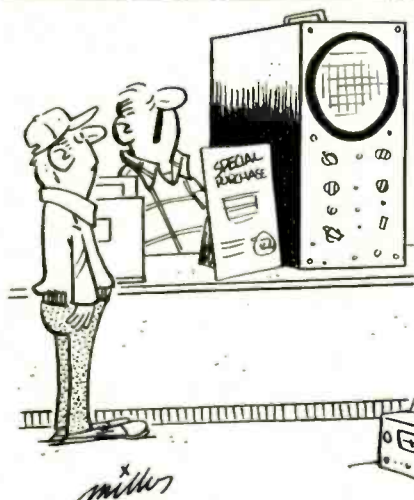

"Their production department misread the engineering drawings by one decimal point."

FREE

The newest in home computers, fine stereo components, color TV, HAM radio, precision test equipment, innovative electronics for the home—all in easy-to-build, money-saving kits.

Send today for your **FREE Heathkit® Catalog**



If coupon is missing, write Heath Co., Dept. 020-812 Benton Harbor, MI 49022

Send to: Heath Co., Dept. 020-812 Benton Harbor, MI 49022

Send my free Heathkit Catalog now. I am not currently receiving your catalog.

Name _____

Address _____

City _____ State _____

CL-724A Zip _____

SEPTEMBER 1981

CIRCLE 22 ON FREE INFORMATION CARD

75

COMMUNICATIONS CORNER

Speech processing can add "punch" to your signal for better DX.

HERB FRIEDMAN, COMMUNICATIONS EDITOR

THE FIRST TRANSMITTER I EVER BUILT was an AM unit with "modulation clipping"—a circuit that simply lopped off the peak of any speech waveform that would have produced more than 100% negative modulation (see Fig. 1-a). (It is carrier interruption, produced by negative peaks "below zero-volts," that causes sideband splatter.)

My latest transmitter is a store-bought appliance with a host of circuits that provide speech processing to increase the average audio level, or "talk power" of my signal. In fact, any circuit or system—regardless how simple or sophisticated—is a "speech processor" if, in any way, it modifies the original modulation so that it can convey more information.

How we increase that "talk power" depends primarily on current technology. The earliest form of speech processing was the modulation clipper I mentioned earlier. Basically, it was a high-voltage rectifier tube in the secondary of an AM plate-modulation transformer. That tube prevented modulation peaks from driving the B+ to the final RF-amplifier plate below zero-volts. When the B+ was driven to precisely zero-volts, the RF amplifier was said to be modulated 100% negative. When the B+ was driven to twice the DC value, the amplifier was modulated 100% positive. Since the positive modulation can be any level without adversely affecting adjacent frequencies, most attention was given to the negative modulation, for if it exceeds 100% the carrier is literally cut off and the RF-distortion products generate spurious signals that cause interference on

adjacent frequencies. (Actually, the FCC was somewhat fussy about the positive modulation, and broadcast transmitters were limited to a maximum of 125% positive modulation.)

Early signal processing

There is a characteristic of the human ear known as "average-power sensitivity" that got technicians working on the idea that the required 100%/125% modulation-limiting could be used to increase that esoteric characteristic called "talk power." While the transmitter's modulation is determined by the modulation's instantaneous peaks, the ear senses the volume of the "average-power modulation level," which is 10 dB to 20 dB below the peak value. For reasons too complex to go into at this time, the peak-to-average ratio is assumed to be 10 dB. In practical terms that means that if the transmitter is modulated to 100% by unprocessed speech, the *effective* modulation level is approximately 30%.

Early radio technicians and engineers figured that, since the modulation peaks aren't necessary to convey intelligence (fidelity, yes; intelligence, no), if the microphone's preamplification was increased so that the modulation was driven deep into peak clipping at the modulation transformer, the average-to-peak ratio would be less than 10 dB, increasing the average modulation level. That would cause the signal to sound louder at the receiving station; in essence, a boost in "talk power." (A peak-to-average ratio of 5 dB provides 55% average modulation-depth.) Logically, with greater clipping all peaks

could be eliminated; and if high volume-levels were clipped to boost low volume-levels effectively, the signal could have an almost unvarying, high, modulation-level. Heavy clipping was tried, but the trouble is that clipped waveforms produce distortion, and the greater the clipping the greater the distortion. It takes heavy filtering above 3 kHz to prevent distortion products from spilling to adjacent RF frequencies; also, beyond a reasonable limit of about 8 dB the distortion makes the signal "mushy," and actually less readable when buried under interference and static.

Out of all this early experimentation came the observation that readability was improved if the voice's normal dynamic range was sharply reduced; that is, if the weak sounds or words could be amplified in relation to the stronger sounds. The most successful early method for transmitters was the "limiting amplifier" (not a peak limiter), a circuit used very successfully in CB transceivers because it does not produce excessive distortion products.

It works this way. The audio preamplifier works at maximum gain until it senses a predetermined input-signal level, after which it provides less than "normal" gain. As a general rule, a limiter provides a 1:2 ratio; above the limiting threshold it delivers 1-dB output for each 2-dB increase in input level. (Some limiters have a 1:3 ratio, providing a 1-dB increase in output level for each 3-dB increase in input level above the limiting threshold.)

Combined peak/volume limiters—often simply called "limiters"—actually provide almost no amplification above the threshold; a 10-dB rise in input level might result in less than 1-dB rise in output level. This type of "limiting" is extremely effective, though it produces excessively "hot" highs because the low frequencies—which are generally considerably stronger than the high frequencies—trigger the threshold, producing reduced gain for the lows and normal or "wide open" gain for the highs. The resulting waveform is shown in Fig. 1-b. This type of limiter is generally used only to protect against over-modulation (since it does not really boost the average modulation level). It's a standard limiter for broadcasting sta-

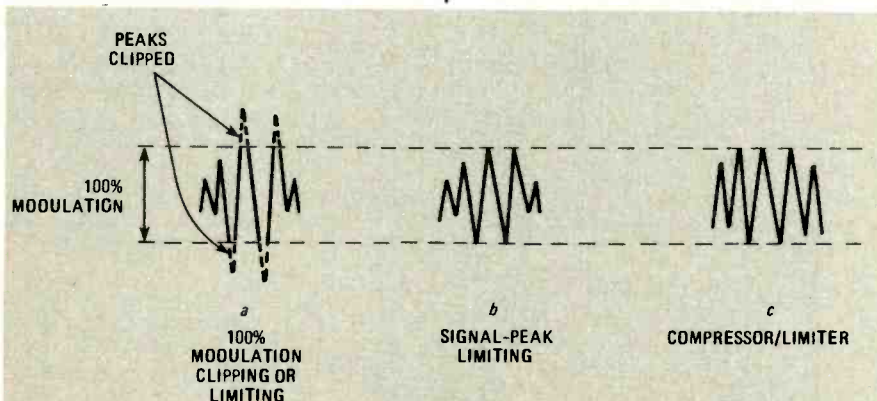

tions that don't process the sound in any other way.

Speech processing today

Solid-state devices really made a big difference in speech processors. Transistors, and in particular IC circuits, are very easily adapted to low-distortion filter designs. The modern speech processor first strips off the frequencies that don't convey much intelligence. Those are the frequencies below about 300 Hz and above 3kHz. The lows help us distinguish who is speaking but we don't need them to convey intelligence. Besides, they burn up a lot of power and tend to foul up limiter and gain-riding adjustments.

The frequencies above 3000 Hz also contribute little to intelligence and take up an unreasonable amount of spectrum.

Finally, we push what's left through a compression amplifier—an amplifier that provides maximum gain to weak signals, and little (or even negative) gain to very loud signals. Combined with peak limiting (fixed peak-signal threshold), what modulates the transmitter is a more or less constant "average power" signal (see Fig. 1-c)—literally a wall of audio. Whether the input signal is a scream or a whisper, it comes out as nearly 100% average "voice-power" modulation.

It would be nice to be able to assign some value and say that processed speech was 10 dB, 15 dB, or 20 dB more effective than unprocessed modulation, but there's really no way to specify a value. A loud sound into the microphone might gain only 6 dB or 10 dB, but a very low voice or a whisper might be 20 dB or even 30 dB more effective than if it were unprocessed. And this is where the advantage really lies: it is the weaker sounds that get the greatest boost through speech processing.

We've come a long way since the early AM transmitter peak-limiters. While a signal may not have the best fidelity, at least we can be certain we will hear all we need to. **R-E**

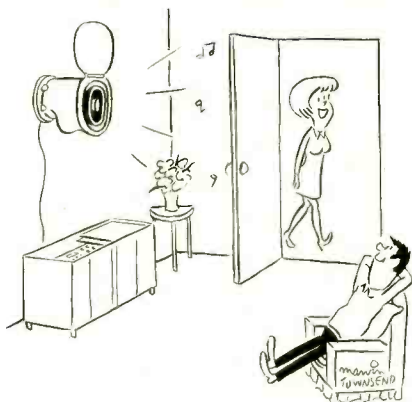

"Beautiful, Henry! How did you ever achieve such clarity and purity of tone?"

RIGHT ON TARGET...



The New RCA Unitized Chassis Field Service Handbook

• YOU ASKED FOR IT!

A handbook that simplifies in-home service diagnosis... requiring a single piece of test equipment... a volt ohm meter.

• YOU NEED IT!

Servicing information based on actual field failures for efficient troubleshooting and repairs... right in the home!

• YOUR CUSTOMER WANTS IT!

No need to take most chassis to the shop for repair... depriving the customer of its use.

• SHOP OWNERS LIKE IT!

Shop owners report in-home set servicing beats the profit squeeze by reducing time and travel expenses.

RCA's new Field Service Handbook shows you how to quickly and simply diagnose the CTC 87, 88, 93, 97, 99, 101 chassis. Step-by-step troubleshooting with a volt ohm meter in the home. Symptoms are traced to their cause with easy-to-read illustrations. Included are recommended component replacement procedures. Handy, loose-leaf binder (120 pages) stays open to the page you need while you work. Only \$8.50 each.

Order yours today—while supply lasts.

RCA

Yes, send me _____ copies of the new Field Service Handbook on the RCA XtendedLife unitized chassis series. My check or money order for \$_____ at \$8.50 each is enclosed.

Please Print—This Is Your Shipping Label

Mail to: RCA
RCA Technical Publications 1-450
600 N. Sherman Drive
Indianapolis, Indiana 46201

8108RE

NAME _____

ADDRESS _____

CITY _____ STATE _____ ZIP _____

SERVICE CLINIC

The more problems, the harder they are to find.

JACK DARR, SERVICE EDITOR

I'VE OFTEN MENTIONED CASES OF DOUBLE troubles: two different problems in the same set. I have also mentioned problems due to overlooking a very significant symptom. We see it, of course, but we don't recognize it for what it means. Here are a pair of "doubles;" different in one way but alike in another.

The first case involves a Magnavox T-910-01. No vertical or horizontal sync at all. After doing some checking, I found that the horizontal oscillator circuit wouldn't "free-wheel." The capacitor across the oscillator coil (hold control) was shorted. Replacing it restored the horizontal sync with a fairly good picture, but still no vertical sync. The oscilloscope showed the vertical sync-pulse present on the coupling capacitor to the vertical oscillator input, but the pulse was very ragged. Checking the output of the video detector showed a problem.

Video was present, but the waveform looked like the one shown in Fig. 1, instead of the normal one. The sync is negative going at that point, as it should be, but note the amplitude of that pulse; it's at least four times too high (and the video is way too low). A bit more looking around with the oscilloscope showed that the AGC filter capacitor, C2 (see Fig. 2), was open. That allowed a number of signals to get into the AGC line, causing feedback. A little experimenting with a capacitor substitution-box showed that marginal filtering in this AGC circuit can cause a loss of picture detail before the vertical sync is affected. That fact may be worth remembering if you run into a similar problem.

That is an elegant example of how much faster you can diagnose a problem when you use a scope intelligently. In fact, in cases like that, it is about the only instrument that will give you any valid data on exactly what the circuit is doing. The key clue in this kind of analysis is to look for the presence of signals (or pulses, etc.) at points where they should *not* be. Do that at any circuit point that is filtered or bypassed.

Now we get to a much worse case, unless you're looking for a good example of how to foul up a fairly easy diagnosis! The set was a Philco hybrid (solid-state IF, etc., and tube ampli-

fiers). When I was called in, the problem was no picture. The screen showed only a pattern of faint vertical bars with "squiggles" in them. The technician said that when the set had first come in the trouble had been a "smooth white screen"—no snow, no picture. He'd tried a tuner-subber on it but without luck. After putting the original tuner back, the symptoms changed.

So, we checked the IF stage. The DC voltages there were close to normal, though the AGC was low. A video signal from a color-bar generator was fed into the grid of the first video-amplifier tube. That signal came through and made a perfect picture on the screen. It told us that everything beyond that point was OK. This also fed some video to the AGC input from the first video-amp's plate-circuit. We found that the AGC didn't work, either.

We now had the trouble pinned down between two points. We tried overriding the AGC with a bias box but that had no effect on the pattern. We still saw the faint bars on the screen. At this point we had all the clues needed to find the trouble, but we didn't know it.

After some more fruitless checking, I had to leave but the technician kept working on it. When I came in the next

day, he told me he had found the problem: The video-detector diode was shorted! The vertical bars/squiggles on the screen were due to a less-than-perfect job of hooking up the tuner IF cable to the chassis! The ground was open, and that upset the IF input.

With perfect 20/20 hindsight, we both agreed that we had overlooked two significant clues. First, the *change* in the symptoms after the tuner substitute had

been tried. That should have told us that something wasn't hooked up correctly. The second was the fact that overriding the AGC had no effect at all on the symptoms. It should have; even if the IF was in oscillation, we should have been able to cut it off and get back the white screen symptom. If we had not been distracted by the tuner-hookup problem, there were a couple of tests that could have been made that would have helped. The scope would have shown nothing at all on the video-detector output. By using a crystal-detector probe on the scope, we could have coupled this loosely to the third video-IF and seen that there was a normal signal at that point. Between this and the output there was only one thing that could cause the problem—the diode.

So, let that be a lesson to you. When you're making tests, pay close attention not just to *what* you're seeing, but especially to what it *means*.

Power supply

I've just gotten some data on a DC power-supply circuit with an unusual feature. Let's have a look at it so that you'll have an idea of what's going on when you run into it. It's used in a Magnavox chassis, the *model 13C2*.

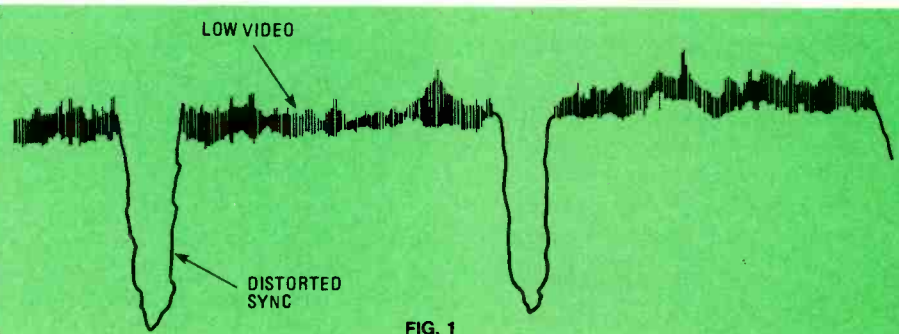

FIG. 1

day, he told me he had found the problem: The video-detector diode was shorted! The vertical bars/squiggles on the screen were due to a less-than-perfect job of hooking up the tuner IF cable to the chassis! The ground was open, and that upset the IF input.

With perfect 20/20 hindsight, we both agreed that we had overlooked two significant clues. First, the *change* in the symptoms after the tuner substitute had

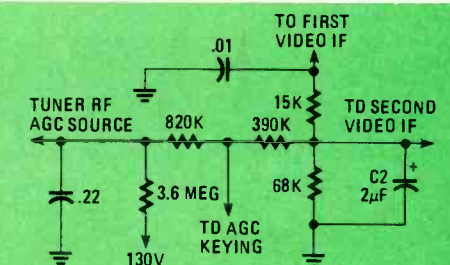

FIG. 2

That is one of those switching-regulator types that have been discussed in previous columns. A pass-transistor does the actual regulating. It is switched on or off to vary the pulse-widths, at the horizontal frequency.

The unusual thing here is that the oscillator used is in an IC on the voltage-regulator board, the 70419 module. Some similar circuits use two horizontal oscillators, one of which is the main horizontal oscillator, with the other one synced to it. Here, there is only the one, and that does it all. The IC also incorporates the phase detector and over-current, over-voltage, and under-voltage protection circuits. It even has a protection circuit to guard against any faults in the control-loop of the IC itself. If any of those circuits are faulty, the same thing happens: The DC power supply is turned off. That is done by simply turning off the pass transistor so that no current flows at all, and that stops everything.

Hope that some of this will be of help, and good luck!

SERVICE QUESTIONS

TOP LINES "TEAR"

I'm tearing my hair over this Sylvania Video Monitor. It works fine, but there's a "tearing" in the first three or four lines at the top of the picture. The rest of the raster is stable. This unit is used as a computer display terminal. The horizontal oscillator will free-wheel, and the tearing disappears in this model! Any help would be appreciated.—J. A., Richardson, TX

Here's a suggestion, and I hope it works! Since you changed the AFC diodes, this stage should be OK. Scope the *bottom* end of the diode unit. There are resistors and bypass capacitors used in this area and if one of them is open, it can create some funny problems. I had a very similar case some time back; I found some of the bypass capacitors were bad. . .after I'd already replaced two or three diode units! Incidentally, an *unbalanced* diode can have the same effect.

INTERMITTENT TURN-ON

The complaint on this Panasonic model CT-254 was intermittent turn-on. Press the switch several times and it would either start or would flicker several minutes, then it worked fine. It played on the bench for seven days in a row, then it started jittering, contracting and expanding in both directions. I changed the pass transistor in the regulator. The set played three days with no problems. I took it home; it wouldn't work!

So, back to the bench. I changed the SCR in the regulator. The set worked for a

Put your ideas in our box.

Meet the Idea Box. The shortest distance between idea and working prototype or one-of-a-kind instrument.

It's a great time-saver! You design the circuit, we provide the power supplies... assembled and tested... and the right case to house it all.

The Idea Box comes complete with three highly regulated low-ripple power supplies (fixed 5VDC @ 1A; + and -15VDC, variable, @0.5A). Plus your choice of a solderless breadboard; a pre-etched, pre-drilled PCB which emulates the hole connection of the solderless breadboard's pattern; or a blank foil board you can use for existing PCB designs. All,

housed in our attractive, high-impact case (4"H x 10"W x 7"D), complete with aluminum front panel and hardware. Priced from just \$149.95*

The Idea Box has the capacity for big ideas as well as small ones. You can stack any of the three circuit cards, in any combination.

So, before you tackle your next project, get a head start with a little help from us: have an Idea Box on hand. After all, good ideas shouldn't be kept waiting.

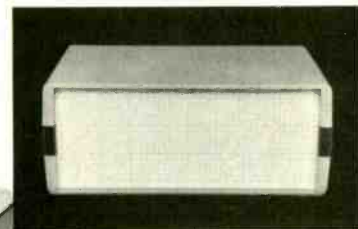

GLOBAL SPECIALTIES CORPORATION

70 Fulton Terr., New Haven, CT 06509 (203) 624-3103. TWX 710-465-1227
OTHER OFFICES: San Francisco (415) 648-0611. TWX 910-372-7992. Europe: Phone Saffron-Walden 0799-21682. TLX 817477
Canada: Len Finkler Ltd., Downsview, Ontario

Call toll-free for details **1-800-243-6077**
During business hours

*Suggested U.S. resale. Prices, specifications subject to change without notice.
© Copyright 1981 Global Specialties Corporation.

CIRCLE 39 ON FREE INFORMATION CARD

SEPTEMBER 1981

79

Now with added words! * ELECTRIC MOUTH



for \$100, Elf II, Apple
TRS-80, Level II* From **\$99.95** kit

Now — teach your computer to talk, increasing interaction between you and your machine.

That's right: the ELECTRIC MOUTH actually lets your computer talk! Installed and on-line in just minutes, it's ready for spoken-language use in office, business, industrial and commercial applications, and in games, special projects, R&D, education, security devices—there's no end to the ELECTRIC MOUTH's usefulness. Look at these features:

- Supplied with 143 letters/words/phonemes/numbers, capable of producing hundreds of words and phrases.
- Expandable on-board up to thousands of words and phrases with additional speech ROMs (see new speech ROM described below).
- Four models that plug directly into \$100, Apple, Elf II and TRS-80 Level II computers.
- Get ELECTRIC MOUTH to talk with either Basic or machine language (very easy to use, complete instructions with examples included).
- Uses National Semiconductor's "Digitalizer".
- Includes on-board audio amplifier and speaker, with provisions for external speakers.
- Installs in just minutes.

Principle of Operation: The ELECTRIC MOUTH stores the digital equivalents of words in ROMs. When words, phrases and phonemes are desired, they simply are called for by your program and then synthesized into speech. The ELECTRIC MOUTH system requires none of your valuable memory space except for a few addresses if used in memory mapped mode. In most cases, output ports (user selectable) are used.

SPOKEN MATERIAL INCLUDED (VOX II)

one	eighteen	at	dollar	inches	number	se	C	t
two	nineteen	cancel	is	of	second	d	u	
three	twenty	case	equal	it	off	set	e	v
four	thirty	cent	error	kilo	on	space	f	w
five	forty	300hertz	tone	feet	out	speed	g	x
six	fifty	800hertz	tone	flow	less	over	star	h
seven	sixty	20ms	silence	fuel	lesser	parenthesis	start	i
eight	seventy	40ms	silence	gallon	limit	percent	stop	j
nine	eighty	80ms	silence	go	low	please	than	k
ten	ninety	180ms	silence	gram	lower	plus	the	l
eleven	hundred	320ms	silence	great	mark	point	time	m
twelve	thousand	cent	greater	meter	pound	try	n	o
thirteen	million	check	have	mile	pulse	up	o	
fourteen	zero	gamma	high	milli	rate	volt	p	
fifteen	again	control	higher	minus	re	weight	q	
sixteen	ampere	danger	hour	minute	ready	a	r	
seventeen	and	degree	in	near	right	b	s	

ADDITIONAL VOCABULARY NOW AVAILABLE (VOX II)

abort	complete	fifth	light	put	station
add	continue	fire	load	quarter	switch
adjust	copy	first	lock	range	system
alarm	correct	floor	longer	reached	temperature
alert	create	fourth	more	record	test
all	de	forward	move	receive	"th"
ask	deposit	from	next	reverse	thank
assistance	dial	gas	no	red	third
attention	door	get	normal	repair	this
blue	east	going	north	repeat	turn
brake	"ed"	green	not	replace	under
button	emergency	hale	notice	room	use
buy	enter	heat	open	safe	waiting
call	"er"	hello	operator	second	warning
called	"er"	help	or	secure	was
caution	"eth"	hurts	pass	select	water
caulus	evacuate	hold	per	send	west
centigrade	exit	key	power	service	wind
change	failure	In	press	side	window
circuit	fast	incorrect	pressure	slow	yellow
cigar	fahrenheit	intruder	process	slower	yes
close	fast	key	pull	smoke	zone
cold	faster	level	push	south	

*Registered Trademarks

Continental U.S.A. Credit Card Buyers Outside Connecticut

TO ORDER
Call Toll Free: 800-243-7428
To Order From Connecticut, or For Technical Assistance, call (203) 354-9375

NETRONICS R&D LTD.
333 Litchfield Road, New Milford, CT 06776
Dept RE

- Please send the items checked below:
- \$100 "Electric Mouth" kit w/Vox I \$ 99.95
 - Elf II "Electric Mouth" kit w/Vox I \$ 99.95
 - Apple "Electric Mouth" kit w/Vox I \$119.95
 - TRS-80 Level II "Electric Mouth" kit w/Vox I \$119.95
 - VOX II (Second Word Set) \$ 39.95

Add \$20.00 for wired tested units instead of kits. VOX II postage & insurance \$1.00, all others \$3.00 postage and insurance. Conn. res. add sales tax.

Total Enclosed \$ _____

Personal Check Cashier's Check/Money Order

Visa Master Charge (Bank No. _____)

Acct. No. _____ Exp. Date _____

Signature _____

Print Name _____

Address _____

City _____

State _____ Zip _____

week then started acting up again! I changed the VDR and checked the junctions on all the regulator transistors. I swapped C805 and C807 and found the sawtooth generator waveform output was a fair squarewave! The same waveform showed up in the clipper. I replaced both capacitors. Now I see a good sawtooth; the set works normally!—L. C., Mena, AR Hooray!

ADDING A HORIZONTAL CENTERING CONTROL

John Rusinko of Little Falls, NJ sends in this interesting idea on how to add a horizontal-centering control to a chassis that does not have one.

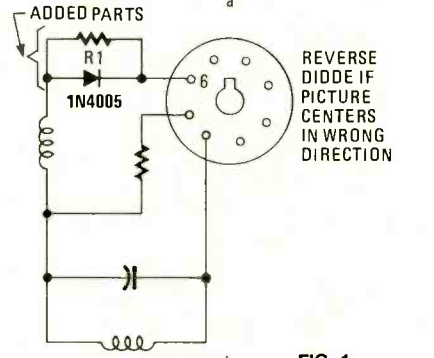
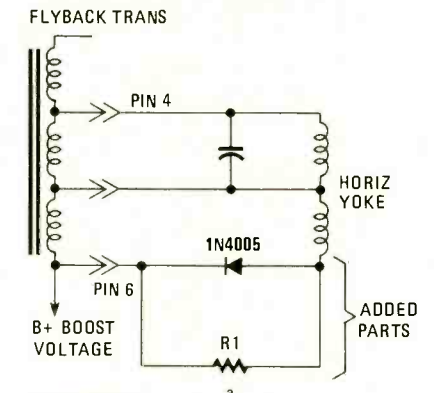

FIG. 1

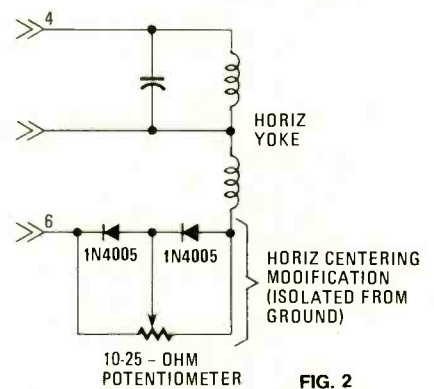

FIG. 2

Lift the lead from pin 6 of the horizontal yoke plug and place the parallel combination of 25-ohm pot and a 1N4005 diode in series with the lead. Adjust the pot until the picture is centered. Measure the value of the pot and then replace it with a fixed resistor. The diode/resistor combination is covered with heat-shrink tubing for safety. The modified circuit is shown in Fig. 1. The value of R1 will, of course, vary from

set-to-set. If you wish, a pot may be permanently installed as shown in Fig. 2, but care must be taken to isolate the pot from the chassis, because boost voltage is present.

BUZZ IN SOUND

Just serviced a Panasonic CT-329. Complaint was low-level buzz from the speaker when the set was turned off via the remote control. It was caused by T801, the remote-power transformer. That is mounted too close to T251, the audio-output transformer. T801 is on even with the set off and it was coupling a 60-Hz signal into the output transformer! Only one screw holds T801 and the leads are long enough to move it to another area a couple of inches away.

Thanks to Frank Ferrell of Bala-Cynwyd, PA for that one.

A 3.16 MEGOHM RESISTOR

In the "Service Questions" column (Radio-Electronics, November 1980) there was a question on a CTC-27X with no color. The stated cure was replacing a 3.16-megohm, 1/2-watt resistor. "There ain't no such thing!" Checking with RCA Service Co. in Medford, MA, they said: "Go out to the open market and buy a 3.3-megohm, 1/2-watt resistor. That will work." I tried it and it does.

Thanks to A.W. Martell of Nick's TV, Watertown, MA and the RCA Service Co. in Medford.

INTERMITTENT GREEN SCREEN

This Panasonic model CT-91T works fine except for an intermittent all-green screen. When this happens, the voltage on the green screen jumps to +840. I changed the green-screen control and the bypass capacitor. At turn-on, the screen stays green for a few minutes, then clears up for an indefinite time. Help!—C. C., Johns Island, SC

Well, you've changed the screen control and the arc-gap capacitor across it. So, something is shorting across the screen control and letting the full boost voltage reach the screen grid. Here's a suggestion: Take off the screen control and examine the location very closely. See if there isn't a short piece of bare wire (the end of the resistor lead, clipped off, etc.) floating around behind the control. This short seems to be "thermal"; i.e., when the set is cold it shorts the control, and when the set heats up, it opens. Solder blobs can also cause these kinds of problems!

COLOR PROBLEM

This model T-995 Magnavox has a bad case of yellow fever! The color intermittently turns yellow and then clears up. Any help would be appreciated.—Q. H., Blue Springs, MO

continued on page 82

EQUIPMENT REPORTS

continued from page 36

between two antennas for different frequency ranges, and selectively feed the tuned signal into one of two separate receivers, or into the two separate antenna jacks frequently found on modern wide-coverage receivers.

Jacks and screw terminals on the rear of the cabinet let you attach antenna leads and connect the unit to the receiver(s). While coaxial cable is recommended for connecting the tuner and the receiver, for short distances insulated single-conductor wire with a separate ground lead or even shielded phone cable can be used.

The *Shortwave/Longwave Tuner* is not an antenna matchbox in the truest sense; it is not intended to provide near-perfect impedance-matching between the antenna system and the receiver. Rather, it is a preselector circuit that can be made resonant at a particular frequency, improving reception on, or near, that frequency while simultaneously rejecting out-of-band interference. That makes the device useful with modern low-cost communications receivers that feature high sensitivity but fall short in selectivity. The background clutter from intermodulation and front-end overload may be reduced or even eliminated with this tuner.

Our test

We tried the *Shortwave/Longwave Tuner* with several receivers: the Radio Shack DX-300 and 302, Kenwood R-1000, Drake R7/DR7, and the Yaesu FRG-7700. While signal improvement varied with the receiver tested, some improvement was noted with every receiver. The improvement was most noticeable on the lower frequency ranges (AM broadcast band and below).

While the manufacturers of most general-coverage receivers capable of tuning below 100 kHz usually state that frequency as a nominal cutoff point, using the *Shortwave/Longwave Tuner* extended low-frequency reception considerably. When used with a 50 to 100-foot wire antenna, reception of WWVB (60 kHz) and even Omega (12 - 15 kHz) was possible! In their literature, Grove Enterprises indicates that the low-frequency reception is best when using a 100-foot insulated wire lying on the ground as an antenna! Using that for low-frequency reception and a shortwave dipole would make an excellent antenna system.

The Grove *Shortwave/Longwave Tuner* is not perfect; in order to keep the cost competitive RF chokes, rather than a large-diameter-wire inductor, were used. As a result, there is series resistance, as well as low Q, on the lowest frequency ranges. Despite that shortcoming, the tuner gives an excellent accounting of itself when used for casual longwave reception, and provides some improvement on the higher frequencies as well.

The *Shortwave/Longwave Tuner* sells for \$59.95 plus \$1.75 shipping from Grove Enterprises, Inc., Brasstown, N.C. 28902. R-E

Thanks to you,
it works.
For all of us.



United Way

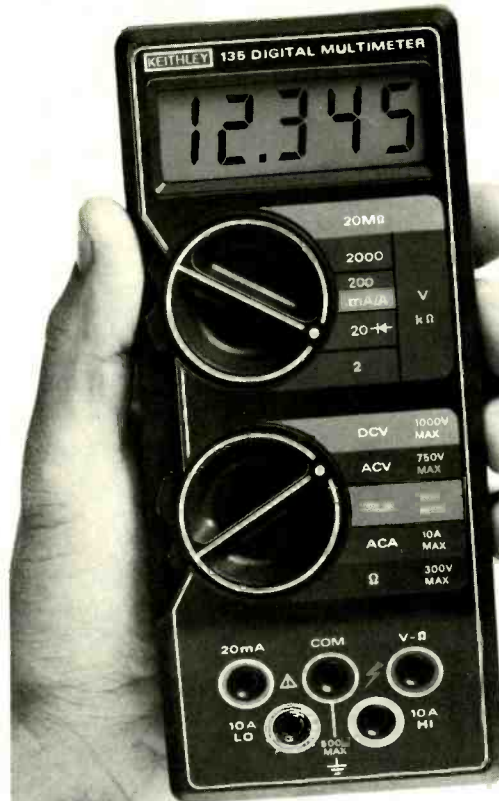

Easily the best.

In terms of resolution and accuracy, the Model 135 is easily the best handheld DMM available at any price. It's the only handheld offering 4½ digits. That gives it 10 times better resolution than the best 3½-digit DMM and provides 3 to 4 times more useable accuracy. Resolution isn't all you get. You get an easy-to-use instrument that's rugged and reliable enough to live in the read world.

You get Keithley packaging. Its large, crisp LCD makes it

easy to read. Rotary switches and a color-coded faceplate make it easy to use. Once-a-year calibration and long battery life make it easy to own. Easy to buy at \$235.

Best in price, best in performance.

There is a DMM designed specifically for your application in the Keithley line. Your Keithley distributor has instruments in stock for your convenience. Call today for complete information and a demonstration.

Sound Choice.

New Model 128 Beeper DMM. Audible/visual indication on all 5 functions of this 3½-digit DMM lets you test faster, and the user adjustable threshold and special diode test function make it a sound choice. Unique features, \$139.



Bench Bargain.

Model 176, Portable Bench DMM. Full 5-function LCD 4½-digit bench DMM offers 0.05% basic DCV accuracy. Keithley ease of use features include range and function annunciators, 1000 hour battery life and optional line operation. A bargain at \$269.



KEITHLEY

Keithley Instruments, Inc.
28775 Aurora Road/Cleveland, Ohio 44139/(216) 248-0400
CIRCLE 46 ON FREE INFORMATION CARD

SERVICE QUESTIONS

continued from page 80

Well, the most likely thing I see in the crystal ball is that you are losing your *blue* completely. This leaves red and green, which together make yellow. So you have to start at the picture tube and eliminate the various possibilities.

Check the control grid, cathode and screen voltages on the blue gun. For example, if you were losing the blue screen voltage, the blue gun would cut off. There are three screen controls on the "Retrace/Screen" module; check

this area for a possible hairline crack or a bad solder joint on the blue screen control.

Check the collector voltage on the blue video output transistor to see if it goes off (either up or down!) when the trouble shows up. If this transistor is intermittently opening, this lets the blue cathode voltage go more positive, which cuts off the blue gun.

LOSS OF VERTICAL SWEEP

There's an odd problem in this RCA CTC-53XP chassis. It begins losing its vertical size, forms a thin line, and then the breaker trips. I found that the vertical os-

illator plate voltage drops slowly, goes clear out, which is when the breaker trips. Can you give me a clue?—A. S., McKeesport, PA

There's one good clue: This plate is fed from the +600-volt *boost*. When you check, you'll see that the *horizontal* oscillator plate is also fed from the same boost voltage. If you lose the grid drive to the 31LZ6, it draws enough current to make the breaker trip.

Try a new 17CT3 damper tube. You might just fix the problem! If this doesn't help, then check through the complete boost circuit from the flyback to the points fed from it. I doubt that this problem is caused by a leaky capacitor, since when this happens, it is usually permanent. However, tubes can short, cool off and clear up.

PICTURE PROBLEM

This Airline model 129462 (Sams 1544-2) has a picture problem. Contrast, brightness and brightness-limiter controls have no effect at all. There's a whitish raster with heavy retrace lines. When I turn up the color a funny picture comes on that looks like a film negative. I tried a new M800 video module with no help. The picture tube is good.—F. C., Gainesville, TX

The crystal ball says you've lost the video or the black-and-white signal. When this happens, turning up the color will give you a funny picture. Since the video module is OK, check back through the video circuits. There's another video-amplifier transistor (Q204) on the front board along with the IF's, etc.

If transistor Q204 is shorted, it will give you a negative video and a severe loss of gain. If the transistor is OK, check the video-detector diode to make sure whether it is open or shorted. There should be 6.2 volts of video signal on the Q204 collector, with the sync going negative; if there isn't, everything from here on in will be bad!

BREAKER TRIPS

After about a minute of operation, the circuit breaker trips in this Sylvania model D-14. If I disconnect the degaussing coil, the set works OK. I decided the coil was bad and replaced it. The breaker still trips! Any leads?—C. G., Amityville, NY

Since there are only two items in the degaussing circuit—the coil and a positive-temperature coefficient thermistor—I suspect that the thermistor is shorted. Because the symptom goes away when this circuit is open, the thermistor is the only thing left to go wrong. This part is a Sylvania No. 38-33206-1. Use only an *exact* replacement. Normal resistance is 25 ohms cold and must go up very quickly.

THICK HORIZONTAL LINE

The screen of this Zenith model 14Z33 shows a horizontal line. The 8BA11 and

Radio-Electronics

SPECIAL REPRINT
BUILD THIS ROBOT FOR UNDER \$400



BUILD YOUR OWN ROBOT!

Send today for your 52-page (8½ × 11") booklet containing complete reprints of all eleven articles in the Build Your Own Robot series by Jim Gupton.

This all-inclusive reprint gives you all the data you need to build your own Robot.

■ TELLS EVERYTHING YOU NEED TO KNOW to build the Unicorn-1 Robot without the need for an engineering degree or special equipment. The robot is fully mobile with manipulator arms to grasp, lift and carry.

■ MANIPULATOR ARMS and end-effectors (hands) are what enable the robot to perform useful tasks. Details of construction techniques and considerations are fully explored.

■ MOBILITY BASE is not a lunar space station. It is the drive system that permits the robot to move from here to there. Full construction details along with a discussion of power sources is included.

■ THE BODY—FRAME AND ROTATION MECHANISM. This is the part that makes Unicorn-1 look like a robot. Wood and Formica are the materials for the body. Motors and gears are what make it function.

■ COMMUNICATIONS. How you can tell your robot what to do. Preprogramming techniques...radio control...computer control are all detailed.

■ SENSORS. How to add sensors so your robot doesn't bump into things.

Radio-Electronics

Robot Reprints
200 Park Ave. South
New York, N.Y. 10003

I want to order _____ reprints @ \$12.00 plus \$1.00 postage and handling for U.S., Canada and Mexico.

Add 96c sales tax for New York State residents only. U.S. Funds only.

I want to order _____ reprints @ \$12.00 plus \$3.00 Air Postage and handling for all other countries.

U.S. Funds only.

Please print

9/81

(Name)

(Street address)

(City)

(State)

(Zip)

Allow 6-8 weeks for delivery.

We do not bill, check must be enclosed.

SPECIAL THIS MONTH

SALE PRICE
GOOD UNTIL
10/31/81

Electronics Paperback Books
Quality Paperbacks at Affordable Prices

To order from this ad: Check off the books you want. Total the prices. Add in shipping. NY State residents add Sales Tax. Total it up, enclose your check and mail.

- 28 Tested Transistor Projects **\$3.50**
- Single IC Projects **\$3.95**
- First Book of Diode Characteristics **\$2.95**
- Electronic Test Equipment Construction **\$4.50**
- 1st Book of Hi Fi Loudspeaker Enclosures **\$3.25**
- Handbook Of IC Audio Preamp and Power Amp Construction **\$3.25**
- 50 Circuits Using Germanium Silicon and Zener Diodes **\$3.50**
- Practical Computer Experiments **\$4.75**
- 50 CMOS IC Projects **\$3.50**
- Digital IC Equivalents and Pin Connections **\$7.50**
- Linear IC Equivalents and Pin Connections **\$7.50**
- Popular Electronic Circuits, Book 1 **\$4.95**
- Digital IC Projects **\$4.95**
- Popular Electronic Projects **\$3.50**
- Electronic Music and Creative Tape Recording **\$3.50**
- Projects In Opto Electronics **\$3.50**
- Electronic Games **\$4.50**

ELECTRONIC PROJECTS FOR BEGINNERS
A wide range of easy to build projects.
No soldering required. Regular price \$3.50
 This month **ONLY \$3.00**

50 CIRCUITS USING DIODES
Circuits and applications in many areas of electronics. Regular price \$3.50
 This month **ONLY \$3.00**

POWER SUPPLY PROJECTS
Regulated, unregulated and variable supplies for semiconductor circuits. Regular price \$4.95
 This month **ONLY \$4.50**

HOW TO BUILD TREASURE LOCATORS
Hetrodyne metal locators can be easy to build. Complete details. Regular price \$3.50
 This month **ONLY \$3.00**

PRACTICAL ELECTRONIC CALCULATIONS
How to solve for any electronic values, and do it easily. Regular price \$5.95
 This month **ONLY \$5.25**



ELECTRONIC TECHNOLOGY TODAY INC. 9/81
17 Slate Lane, Central Islip, NY 11722

Price of Books
Sales Tax (NY State Residents only)
Shipping and Handling
(60c 1 or 2 books. 25c each add.)

TOTAL

Name
Address
City State Zip

10GK6 tubes test OK, but the vertical linearity and vertical size controls do nothing. Any ideas?—J. P., Brooklyn, NY

I have one: I note (from the photo you sent along) that the screen line is approximately an inch high and not very thin. This generally means that the vertical-output stage is trying to work. It picks up enough stray AC on its grid to create a thick line.

However, the vertical oscillator obviously isn't running. Using just your fingertip, touch the 8BA11 pin 9 grid, the input grid of the vertical oscillator. If this causes the vertical deflection to increase slightly, you have eliminated this tube as a cause of the symptom. The chances are that one of the parts in the feedback loop is open; without feedback, there's no oscillation.

MORE BROADMOOR DATA

George R. Welker, Spokane, WA sends this supplemental data on Broadmoor chassis. He says that the 6911-C chassis was made by Midland for many private labels such as Bradford, Tru-tone, and Coronado as well as Broadmoor! You can get parts and data from Midland International Corp., 1900 Johnson Drive at State Line Road, Shawnee Mission, KS 66205.

Thanks a lot, George! If we keep on trying, we'll get some useful data in our files on those. R-E

$x^3 + 7x - 4 = 0?$

It looks HARD with that x^3 term, but it's EASY to get $x = .547928287$.
Use your calculator Right Now to

INFINITE-LIMIT METHOD:

Set $x^3 + 7x - 4 = (x^2 + 7)x$ and then $x = 4/(x^2 + 7)$. Now make a first guess of $x = 1/2$ and use it on the right-hand side to calculate $4/(.5^2 + 7) = .55...$ Let .55 be your second guess and get $4/(.55^2 + 7) = .5477...$ for your third guess. Repeat this process for greater and greater accuracy. **WANT TO KNOW MORE?**

• QUICK • EASY • GUARANTEED • FUN, TOO!

INTRIGUED BY CALCULATORS? Then you can step up your math skills fast! Use my new method in guidebook form. It's called **CALCULATOR CALCULUS** and comes with this guarantee: *If after 10 days you're not astounded at the problems you're solving on your own calculator, return the guidebook for an immediate refund.*

But the point is - you won't want to send it back. For this is the *easiest, fastest shortcut ever!* The day you receive your copy in the mail you'll want to put it to work. It's that exciting and helpful.

My name is Dr. George McCarty. I teach math at the University of California. I wrote this guidebook to cut through the confusion. It does just that — with worked-out examples, simple exercises and practical problems — all designed to work with precision and magic on your calculator!

POWER METHODS. Need to evaluate functions, areas, volumes — solve equations — use curves, trig, polar coordinates — find limits for sequences and series? It's all here!

If you're in the biological, social or physical sciences, you'll be doing Bessel functions, carbon dating, Gompertz' growth curves, half-life, future value, marginal costs, motion, cooling, probability, pressure — and plenty more (even differential equations).

Important numerical techniques? Those algorithms are here, too-rational and Padé approximation, bracketing, continued fractions, Euler's method, Heun's method, iteration functions, Newton's method, predictor-corrector, successive substitutions, Simpson's method and synthetic division.

LOOK AT WHAT USERS SAY: Samuel C. McCluney, Jr., of Philadelphia writes:

"**CALCULATOR CALCULUS IS GREAT!** For ten years I have been trying to get the theory of calculus through my head, using home-study courses. It was not until I had your book that it became clear what the calculus was all about. Now I can go through the other books and see what they are trying to do. With your book and a calculator the whole idea becomes clear in a moment, and is a MOST REFRESHING EXPERIENCE. I program some of the iterative problems you suggest and it always GIVES ME A THRILL

to see it start out with a wild guess and then approach the limit and stop."

Professor John A. Ball of Harvard College (author of the book *Algorithms for RPN Calculators*) writes: "I wish I had had as good a calculus course."

Professor H. I. Freedman of the U. of Alberta, writing in *Soc. Ind. Appl. Math Review*, states: "There can be no question as to the usefulness of this book...lots of exercises...very clearly written and makes for easy reading."

C. B. of Santa Barbara says: "Your book has given me much instruction and pleasure. I do not hesitate to recommend it. **CALCULATOR CALCULUS** is a book that inspires the reader to understand everything down to the last detail. You seem to have put your heart into the teaching."

I WANT YOU TO TRY THIS. Get my complete kit, with a TI-35 calculator, a 200 p. Student Math Book, AND the guidebook, ALL for \$39.95 (to USA only; add \$2 for shipping, or \$5 by AIR; in Calif. add \$2.40 tax. Foreign \$5, or \$10 AIR.)

If you already have a scientific calculator, you can invest in **CALCULATOR CALCULUS** for only U.S. \$14.95 (to USA or foreign; add \$1 for shipping, or \$4 by AIR; in Calif. add 90c tax). As pennywise Ben Franklin said, "An investment in knowledge pays the best dividends." **GET STARTED NOW** — Tax deductible for professionals.

NO RISK WHATEVER! Send for it today. Be sure to give me your complete mailing address with your check or money order. If you want to charge it (Visa or MC), tell me your card no. and exp. date. Prompt shipment guaranteed.

George McCarty
Thank you!

EduCALC Publications, Dept. D-8
Box 974, Laguna Beach, California 92652
In Calif. (also AK and HI), call 714-497-3600;
elsewhere: TOLL FREE 24-hour Credit Card orders:
800-854-0561, Ext. 845; Dept. D-8

T E A R A N D M A I L S E P T E M B E R 1 9 8 1

NEW IDEAS

Simple Tesla coil

I'M SURE THAT MANY READERS FOUND the article on the recreation of Tesla's original experiments by Robert Golka (see *Radio-Electronics*, February 1981 issue) very interesting. I know that I did, especially since I built a small version of a Tesla coil not too long ago (although I'm only age 14). I'd like to share the details with you.

There is one important thing to keep in mind before we even begin: The Tesla coil described here can generate 25,000 volts so, even though the output current is low, **be very careful!**

The main component of the Tesla-coil circuit is a flyback transformer. You can get one from a discarded TV.

The first thing you must do is to get rid of any excess wire or other debris that's on the transformer's core, as shown in Fig. 1. Leave the high-voltage winding alone; but if there is a capacitor at the end, it should be removed.

After that, you can start winding a new primary coil. Begin by winding 5 turns of No. 18 wire on the core. Then

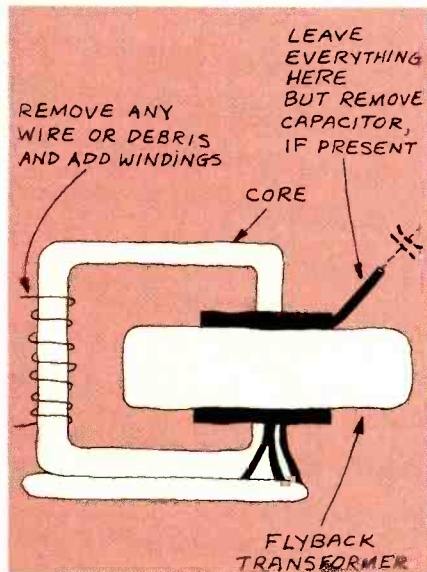

FIG. 1

twist a loop in the wire and finish by winding five more turns. Wrap with electrical tape, but leave the loop exposed.

A four-turn winding has to be wound over the ten-turn winding that you've just finished. That is done the same way. First wind two turns of No. 18

wire, then make a loop, and finish up by winding two more turns. Again, wrap the new winding with electrical tape, leaving the loop exposed.

When the windings are finished, the two loops shouldn't be more than ¼-inch apart (but take care that they do not touch). Connect a 240-ohm resistor between the two loops. The modified transformer now should look like the one shown in Fig. 2.

Connect the transformer as shown in Fig. 3. The 27-ohm resistor and the two transistors should be mounted on a heat sink and *must be insulated from it*.

The output of the high-voltage wind-

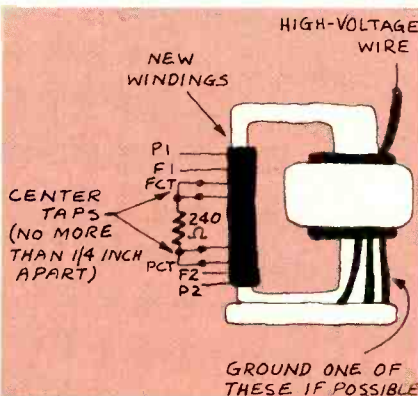

FIG. 2

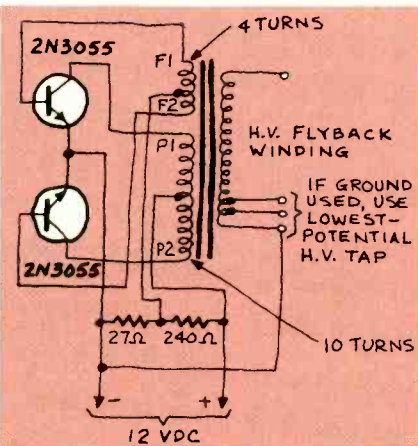

FIG. 3

ing should begin to oscillate as soon as the circuit is connected to a 12-volt DC power supply. If it does not, reverse the connections to the base leads of the transistors. In normal operation, you should be able to draw 1-inch sparks from the high-voltage lead using an insulated screwdriver.—Eric Wold

NEW IDEAS

This column is devoted to new ideas, circuits, device applications, construction techniques, helpful hints, etc.

All published entries, upon publication, will earn \$25. In addition, Panavise will donate their model 324 Electronic Work Center, having a value of \$49.95. It combines their circuit-board holder, tray base mount, and solder station (see photo below). Selections will be made at the sole discretion of the editorial staff of *Radio-Electronics*.

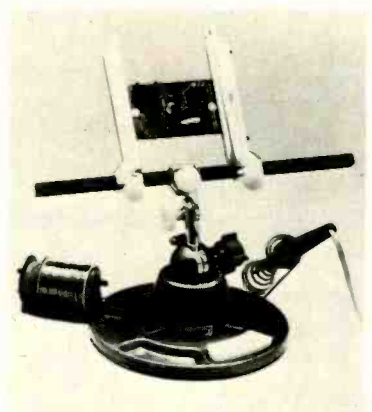

I agree to the above terms, and grant *Radio-Electronics* Magazine the right to publish my idea and to subsequently republish my idea in collections or compilations of reprints of similar articles. I declare that the attached idea is my own original material and that its publication does not violate any other copyright. I also declare that this material had not been previously published.

Title of Idea

Signature

Print Name

Date

Street

City

State

ZIP

Mail your idea along with this coupon to: **New Ideas Radio-Electronics, 200 Park Ave. South, New York, NY 10003**

All new! All construction projects!

Here's the brand new issue of—*Radio-Electronics Special Projects*—page after page of new and unique construction articles on Test Equipment, Computers, Electronic Music, Communications, Automotive and Hobby Projects.

They're the kind of projects you want to build, the kind only *Radio-Electronics* has the expertise to design, and this new issue is filled with great construction articles like these:

Test Equipment
Digital Scope Multi-plexer—to convert almost any scope into a 4-trace unit.
Frequency Multiplier—to extend the range of your frequency counter.
Safety Cooker—that protects unattended equipment against electrical problems.
Battery Box/Switching Box—a great accessory for any bench.
Car Test Probe—use it to test auto-

motive electrical systems.
Digital IC Tester—to make quick work of testing digital IC's.

Electronic Music
The Chord Egg—to generate an endless series of chords automatically.
Words And Music—a programmable music generator that's ideal for doorbells.
Big Sound For Chord Organs—to enhance the sound

from electromechanical chord organs.

Computers
Digital Logic Trainer—that teaches how microprocessors work.
Save Your Files—cassette tape recorder controller makes using tape as computer memory storage easy.
Programmable Sound Generator—adds sound capability to almost any computer system.

Hobby
Adventures of the IC's—applications for LM3914 and VMOS power FET's.
Digital Do-Nothing Box—lights, counts, teaches binary and digital number systems.

Communications
Digital Readout Add-on For Communications Receivers—to update older receivers easily.
Microphone Acoustic Coupler—a sim-

Lots Of
Brand New
Projects Inside!

Radio-Electronics
Special Projects
The magazine for people who like to build electronic gizmos
\$2.25
FALL
1981

Projects.... Projects.... Projects.... Projects.... Projects....

TTY Printer Controller
For Your TRS-80

Brain-Light Warning System
For Your Car

How to Make PC Boards
For Your Projects

Electronic Finger Drums

Printmeter For Photographers

Walkie-Talkie Initiator

Stereo Timer

Everything You Need To Know
About Electronic Kits

Compresso-Amplifier

Super-Sensitive Field
Strength Meter

Time-Delay For Better Stereo

We will ship your magazine, postpaid in U.S. and Canada, within 6 weeks of receipt of your order. All other countries add \$3 for postage.

I want _____ magazines @ \$3.00 each. First-Class postpaid. Includes handling (U.S.A. & Canada)

I have enclosed \$ _____ (Foreign, add \$3.00 for Air Mail postage per copy.) US Funds only

Radio-Electronics
Special Projects

45 East 17th Street
New York, N.Y. 10003

RE9-81

Name		
Street Address		
City	State	Zip

Generate virtually any wave shape with famous B&K-PRECISION cost-effectiveness!



Model 3010/\$220

Model 3020/\$379

The B&K-PRECISION Model 3020 sweep/function generator is the most versatile signal source in its price range. This instrument alone can replace a function generator, sweep generator, pulse generator and toneburst generator. Frequency coverage spans 0.02Hz to 2MHz in seven ranges, each with linear 1000:1 frequency control.

A low-distortion, high-accuracy signal source, the 3020 can generate almost any waveform, including sine waves, square waves, TTL square waves, toneburst, pulses and ramps. All can be inverted. Internal linear and log sweep capability is also featured. Both modulation and carrier levels can be varied so even a double sideband suppressed carrier test signal can be generated.

For applications requiring standard signals, the Model 3010 low distortion function generator is offered. The 3010 generates sine, square, TTL square and triangle waveforms from 0.1Hz to 1MHz in six ranges. An external VCO input is provided for sweep frequency tests. Variable DC offset is included.

The 3020 and 3010 are available for immediate delivery at your local distributor. A ten day free trial is available at many locations.

BK PRECISION
DYNASCAN
CORPORATION

6460 West Cortland Street
Chicago, Illinois 60635 • 312/889-9087

Int'l. Sls.: 6460 W. Cortland St., Chicago, IL 60635
Canadian Sales: Atlas Electronics, Ontario

CIRCLE 47 ON FREE INFORMATION CARD

NEW PRODUCTS

For more details use Free Information card
inside back cover.

FREQUENCY COUNTER, model *IM-2420*, is a new 512-MHz digital frequency counter that is available both in kit and fully-assembled versions.

The model *IM-2420* features four gate times and 8-digit resolution for precise readings. It does more than just measure the frequencies of input signals. A period function can give cycle time in seconds, while the frequency-ratio function provides the user with the ratio between two input frequencies.

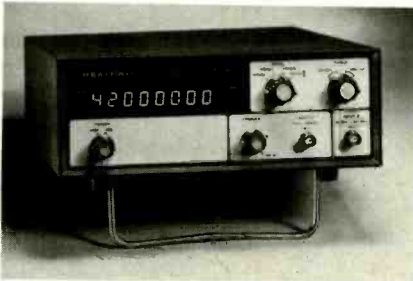

CIRCLE 50 ON FREE INFORMATION CARD

A standby power switch keeps the crystal oven warm for maximum frequency accuracy. The oven is proportionally-controlled to keep the internal time base within 0.1 part per million over a wide temperature range. The crystal-controlled time base provides long-term stability, with drift controlled to less than 1 ppm per year. There are also provisions for using external time-base signals.

Four gate times and a 0.43-inch-high, 8-digit LED display provide the resolution needed to measure UHF signals. Trigger-level control assures stable counting when noise is present, and provides more accurate measurement of complicated waveforms. Frequency measurements can be made by direct connection, or by using the optional *SMA-2400-1* swiveling telescopic antenna. The model *IM-2420* can be wired for either 120 or 240 VAC operation.

The model *IM-2420* is priced at \$239.95 as a kit, with a complete step-by-step assembly manual; the factory-assembled and tested version, model *SM-2420*, is priced at \$299.95.—**Heath Company**, Benton Harbor, MI 49022.

ASCII ENCODED KEYBOARD KIT, the *JE610*, is designed to interface with almost any computer system. It comes complete with a 62-key keyboard switch assembly, IC's, sockets, connector, and a double-sided PC board. The switches are SPST mechanical action, and 60 keys generate the 128 characters (both upper and lower case) of



CIRCLE 111 ON FREE INFORMATION CARD

the ASCII set. Two user-defined keys are provided for custom applications. The unit is fully buffered and there is a "caps lock" for upper case and alpha characters. The system has a 40-pin ROM with outputs compatible with TTL/DTL or MOS logic arrays. The keyboard assembly requires +5 VDC at 150 mA and -12 VDC at 10 mA for operation. Interfacing is accomplished by a 16-pin DIP socket or an 18-pin edge card connector. Step-by-step wiring instructions and circuit diagram are also included. Suggested retail price is \$79.95, less enclosure. Available in kit form only.—**Jameco Electronics**, 1355 Shoreway Rd., Belmont, CA 94002.

FM PORTABLE: Two new options are now being offered by Motorola for their *Series MT500* FM 2-way portable radios—*touch code*, and *touch-code* encoders with automatic number identification (ANI). The *MT500* series includes almost 100 different models, each specifically tailored to the customer's options.



CIRCLE 112 ON FREE INFORMATION CARD

Those new options encode dual-tone multi-frequency (DTMF) tones which enable the user to control devices remotely, or to place telephone calls when interconnected with the proper system. The ANI feature expands the encoder option to identify the user and acknowledge valid system-entry automatically. ANI is the function of a hybrid programmable PROM that plugs into the radio front cover, thus leaving internal space for additional options.

The *touch-code* option is \$200 additional; the *touch-code ANI* option is \$260.00 additional.—**Motorola, Inc.**, c/o Pat Schod, Communications Group Public Relations Dept., 1301 E. Algonquin Road, Schaumburg, IL 60196.

INTEGRATED AMPLIFIER, the *Plus A75*, features a moving coil preamplifier and left- and right-channel 12-stage LED input/output peak indicators. The preamp section features a wide-band, DC-coupled Class A design. Controls include "triple-turnover" bass and treble equalizers, a sharp-cutoff switchable subsonic filter, and separate dubbing and monitoring facilities for two tape decks.

The *Plus 75* has a minimum rated power of 75 watts-per-channel into four or eight ohms. Response is from 20 Hz to 20 kHz with less than

NORMARK®

introduces

Factory Accessories For The Do-It-Yourselfer:

Power Windows

Power Door Locks

Automatic Headlight Control

Lights-On Alarm

Wiper Delay Control

Power Trunk/Hatchback Release

Low Washer Fluid Alarm

Low Coolant Level Alarm

Low Fuel Alarm

Electronic Dipstick™

Normark has just what your car, van or truck needs. Write for a complete catalog and name of your local dealer.

NORMARK®

Manufacturing Corporation
2000 Hurd Drive, Dept. RE-9
Irving, Texas 75062
(214) 659-1800

©1981 Normark

CIRCLE 34 ON FREE INFORMATION CARD



CIRCLE 113 ON FREE INFORMATION CARD

0.009% THD. The LED display shows not only output power but can also show input levels to aid in monitoring the output of signal sources connected to the amp. The amp section uses fully complementary DC-coupled output devices that have a slew rate of 120 volts-per-microsecond. Suggested retail price is \$509.95.—Sanyo Electric, Inc., Consumer Electronics Div., 1200 W. Artesia Blvd., Compton, CA 90220.

SPEECH CONTROLLER, the VSC (Variable Speech Control), offers self-paced listening. Recent studies show that comprehension and retention increase by as much as 42% when material is heard at a rate of 250 to 300 words per minute—twice as fast as most people speak. The VSC Speech Controller enables the user to regulate that speed.



CIRCLE 114 ON FREE INFORMATION CARD

For studying, previewing, transcribing, reviewing, or analyzing tapes of lectures, conferences, interviews, or personal notes, the unit can play up to 2½ times faster than a normal recorder and still reproduce voices without distortion. Speech can also be slowed down without distortion.

There is a built-in microphone, 3-digit counter, record-level meter, cue-review control, 12-volt-DC adaptor jack, headphone, earphone, and remote microphone jacks. An external microphone, earphone, and stand are also available as accessories.

The VSC Speech Controller is priced at \$259.00.—Edmund Scientific, 7082 Edscorp Bldg., Barrington, NJ 08007.

HI-FI PREAMPLIFIER, Linear Preamp, is designed to serve as the basic control/preamp unit of any stereo setup. In addition to the standard function-select controls, the unit features a sub-



CIRCLE 115 ON FREE INFORMATION CARD

sonic filter, two tape-monitor circuits plus selection of either the left or right channel in the monoaural mode and channel-reverse capability in the stereo mode. A gain switch offers 20 dB of additional gain when needed. This compact preamp is housed in an enclosure with solid walnut end

A LOW-BUDGET COURSE IN SOLID STATE CIRCUITS

ED NOLI'S SOLID STATE CIRCUIT FILES VOLUMES I & II provide sensible you-do-it experience with solid-state circuits. Bipolar transistors, field-effect transistors, linear integrated circuits, TTL digital circuits and CMOS integrated circuits are covered. More than 100 basic and advanced circuits. Each circuit is complete, fully explained, and most include suggested procedures for experimentation. All use low-cost, readily available components. Circuits can be constructed quickly on a solderless breadboard. Available from your local electronic distributor.

If you're a student, technician, experimenter, radio amateur, teacher or computer enthusiast, order these invaluable solid-state circuit training programs today.

VISIT SAMS AT
WESCON. BOOTH NOS.
1516 & 1518.



SAMS BOOKS

Mail to: Howard W. Sams & Co., Inc., 4300 West 62nd St., P.O. Box 7092, Indianapolis, IN 46206.

	Quantity	
Volume I—Bipolar Transistor, Fet, & Linear IC Circuits	No. 21753	\$ 7.95
Volume II—TTL & CMOS Circuits	No. 21754	\$ 7.95
Two Volume Set	No. 21752	\$14.50
Amount of order \$ _____		

Add local sales tax where applicable \$ _____

Shipping & handling costs \$ 2.00

Total amount of order \$ _____

Payment Enclosed Check Money Order
 VISA MasterCard Interbank No. _____

Account No. _____ Expiration Date _____

Name (print) _____

Signature _____

Address _____

City _____ State _____ Zip _____

Call toll-free 1-800-428-3696 for the name of your local Sams Book outlet or to order by phone. Offer good in U.S.A. only. Offer expires 1/31/82. AD118

CIRCLE 19 ON FREE INFORMATION CARD

LEARN MICROPROCESSING on your own computer!

You Learn How To:

- Design & code microprocessor software
- Use logic & Bit Manipulation Techniques
- Enter & execute programs on your own computer
- Understand Microprocessor Architecture & Support Chips
- Control Programmable Input/Output Ports
- Implement Real-Time Interrupt Handling & Data Transfer
- Design your own microcomputer



8085 MICROPROCESSOR TRAINING UNIT \$299.95

You Will Receive:

- A fully tested and assembled 8085A Microcomputer with 1K RAM, 1K EPROM and 1K PROM Memory, Programmable I/O, keyboard Unit, CPU Card, Display and Operating System. 44 pin edge connector can be configured to any bus structure, area on CPU Card for Custom wire-wrap design or user defined interface circuitry, completely expandable
- Complete Step-by-Step Instruction Manual
- Complete User's Manual with programs included
- 352 page 8085A Cookbook takes you from basic microprocessor concepts to actual design of an 8085A Microcomputer
- 344 page 8080/8085 Software Design Book 1 with over 190 executable program examples plus detailed examination of all 244 instructions, and typical assembly language program for the 8080/8085 Microprocessor

Satisfaction Guaranteed. If not completely satisfied you may return the product within 30 days for a full refund

RATED BEST VALUE BY INSTRUCTORS

PRCCOM CREDIT CARD ORDERS CALL TOLL-FREE

3928 148th N.E., Dept. RE9
REDMOND, WA 98052

1-800-426-6254 EXT. 19

YES! I want to start learning Microprocessors. Please rush me:

8085AAT Microprocessor Training Unit at \$299.95 plus \$3.00 P & H
 8085 Cookbook 21697 \$12.95 8080/8085 Software Book 21541 \$9.50

NAME _____ VISA MSTRCD

ADDRESS _____

CITY _____ ST. _____ ZIP _____

CARD NO _____ EXP. DATE _____

SIGNATURE _____

CIRCLE 26 ON FREE INFORMATION CARD

MHz, and also provides 1500:1 linear up or down sweeps, with adjustable sweep durations from



CIRCLE 118 ON FREE INFORMATION CARD

1000 seconds to 1 millisecond. There is also variable DC offset and auxiliary TTL output.

The model 1200A is priced at \$395.00.—Krohn-Hite Corporation, Avon Industrial Park, Avon, MA 02332.

PRINTERS, *EUY-5E* and *EUY-5T* are miniature alphanumeric printers, that print either on electro-sensitive paper (*EUY-5E*) or thermosensitive paper (*EUY-5T*). Both print 32, 40, 64, or 80 characters per line. Characters are formed by a 7 X 5 dot matrix, and are 0.11-inch high. The *EUY-5E* can print two lines per second while the *EUY-5T* prints 0.8 lines per second. Both printers measure 7.68 X 2.56 X 2.76 inches and print on 5-inch wide paper and have an expected life of 1 X 10⁶ lines; that makes them suitable for applications where inexpensive hardcopy output is required, including computer peripherals, measuring instruments, analyzers and others.

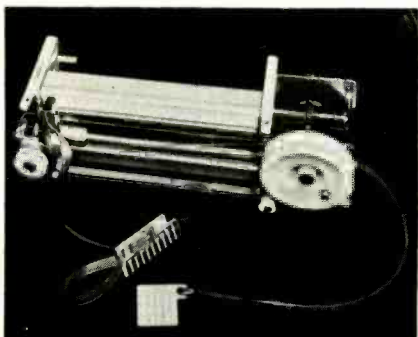

CIRCLE 119 ON FREE INFORMATION CARD

The printers come without a case, ready to be mounted and connected via their ribbon cables and PC connectors. The *EUY-5E* requires two ±24 VDC sources at 100 mA each and a +5 VDC supply at 30 mA. The *EUY-5T* requires one ±24 VDC supply at 100 mA, one ±24 VDC at 1 amp for the thermal head, and +5 VDC at 30 mA for the logic. In OEM quantities, the *EUY-5E* is priced at \$145 and the *EUY-5T* is priced at \$196.—Panasonic, Electronic Components Div., 1 Panasonic Way, Secaucus, NJ 07094.

ANTENNA TUNERS, models 228 and 227, feature two-inch, 47-tap toroids with silver-plated 18-gauge wire and tap selectors. Used in a wide-range "T" network with variable capacitors, the toroids permit vernier tuning for easy, accurate adjustment.



CIRCLE 120 ON FREE INFORMATION CARD

pieces and a black anodized finish. The unit measures 1 1/4 X 19 X 6 inches. Suggested retail price is \$330.—MXR Innovations, Inc., 740 Driving Park Ave., Rochester, NY 14613.

POWER SUPPLY, the *AppleJuice* model *APS-3*, is a reserve power supply that provides one-hour back-up power for the *Apple II* Computer and *Apple*-powered peripherals during power flickers, prolonged outages, and brownouts. During an outage, the *AppleJuice* alerts the user visually,



CIRCLE 116 ON FREE INFORMATION CARD

audibly, and electronically that there is a power failure, giving the user time to bring the system to an orderly shutdown with all data files intact. An interrupt feature can be used to generate an interrupt to transfer memory content automatically to disk or to operate any external device requiring less than 60 mA. Suggested retail price is \$295.00. A 20-minute version is available for \$249.00.—High Technology, Inc., P.O. Box 14665, Oklahoma City, OK 73113.

TWO-WAY BUSINESS RADIO, model 867L, is a 30-watt VHF FM unit available with either one or two channels. Designed for mobile use or as a base station, it operates in the 140- to 174-MHz frequency range. There is an advanced Hi-Q



CIRCLE 117 ON FREE INFORMATION CARD

receiver on the front end, to insure sensitivity and selectivity of signal reception. The automatic transmitter power control maintains a steady transmission at the rated power output over a widely varying input voltage. A microstrip RF power amplifier reduces tuning time and makes for over-all easier alignment and service. Private channel (CTCSS) operation is available as an option. The model 867L is priced at \$425.00 for the one-channel version, \$446.00 for the two-channel version.—Standard Communications Corp., P.O. Box 92152, Los Angeles, CA 90009.

FUNCTION GENERATOR, model 1200A, includes the *Waveguard* output-protection circuit that was available formerly only at extra cost. That circuit prevents damage to the generator's output stage if an external voltage is applied accidentally across the generator's output terminals. The *Waveguard* circuit recovers automatically when the external voltage is removed.

The model 1200A provides 20-volt P-P sine, square, and triangle waveforms from 0.2 Hz to 3



FREE!
1981
DISCOUNT
ELECTRONICS
CATALOG

JOIN THE PAK!

Send for our Free catalog and become a member of our exclusive Pak. Our members receive Poly Paks' exciting catalog several times a year. We offer:

- Penny Sales, Free Premiums and Low, Low Prices on a wide variety of

Electronic Products such as Computer Peripherals, Integrated Circuits, Speakers, Audio Equipment, Rechargeable Batteries, Solar Products, Semiconductors, and much, much more! Take advantage of our 25 years as America's foremost Supplier of discount electronics.

RUSH ME YOUR FREEDISCOUNTCATALOG!

NAME: _____

ADDRESS: _____

CITY: _____

STATE: _____ ZIP: _____

CLIP AND MAIL COUPON TODAY TO:
POLY PAKS, INC.

P.O. Box 942, R9B
S. LYNNFIELD, MA. 01940 (617) 245-3828

CIRCLE 16 ON FREE INFORMATION CARD

Over
4.5 Million
Satisfied
Customers

Put Professional Knowledge and a
COLLEGE DEGREE
in your Electronics Career through
HOME STUDY

Earn Your DEGREE

No commuting to class. Study at your own pace, while continuing your present job. Learn from easy-to-understand lessons, with help from your home-study instructors whenever you need it.

In the Grantham electronics program, you first earn your A.S.E.T. degree, and then your B.S.E.T. These degrees are accredited by the Accrediting Commission of the National Home Study Council.

Our free bulletin gives full details of the home-study program, the degrees awarded, and the requirements for each degree. Write for *Bulletin R-81*.

Grantham College of Engineering
2500 So. LaCienega Blvd.
Los Angeles, California 90034

SCR SUPER-BUYS



\$100⁰⁰ MIN. ORDER HANDLE/SHIP \$5⁰⁰

- ① **UHF VARACTOR-TUNER.** Channels 14-83 tunable. I/O = 75 ohms. Power Gain = 10-20 dB max. Complete with schematic and tech data. Brand new - surplus. **\$23⁹⁵**
- ② **NI-CAD 5 AA BATTERY PACK** in shrink tube with solder tabs. Brand new - surplus. **\$6⁹⁵**
- ③ **CABLE TV CONVERTER.** For conversion to midband and superband cable stations. Brand new and its LEGAL! **\$34⁹⁵**
- ④ **BRAND NAME POWER SUPPLIES** ±5V/6A. Voltage adjustable and IC regulated. Ideal for CMOS, computer-based instruments, etc. use. Brand new - surplus **\$23⁹⁵**
- ⑤ **MODULATOR.** Video and sound input with 75 ohms output. Switchable to channels 3 or 4. Shielded case. Brand new - surplus. **\$16⁹⁵**

UPS ANYWHERE IN CONTINENTAL U.S.
Pay by CHECK, M.O., VISA, M/C, C.O.D.
9533 Valley View, Cypress, CA 90630
SCR ELECTRONICS INC.
(714) 527-2554
For Free Buyers Guide Circle No. 32

CIRCLE 32 ON FREE INFORMATION CARD

A front-panel five-position ANTENNA SELECT switch offers a choice of dummy load, one of three different antennas, or tuner bypass for one of the antennas. Also, one antenna may be a long-wire type.

The tuners will match conventional 50-75 ohm unbalanced outputs to a variety of unbalanced or balanced load impedances. A built-in balun converts one antenna to a balanced configuration if desired (max. balanced load on 160 and 80 meters is 500 ohms). Power ratings are 200 watts RF intermittent, 100 watts continuous (ideal for any transceiver with input power up to 200 watts).

The model 228 has a built-in SWR bridge, FORWARD/REVERSE switch, SENSITIVITY control, and a meter that indicates SWR's between 1:1 and 5:1. The size is 3 3/8 X 10 1/2 X 7 3/4 inches. Model 227 is identical except that there is no SWR bridge, and the size is 3 3/8 X 8 1/2 X 7 3/4 inches. Both models are styled to match Ten-Tec transceivers.

The model 228 is priced at \$95.00; the model 227 sells for \$79.00.—Ten-Tec, Inc., Highway 411 East, Sevierville, TN 37862.

LOUDSPEAKERS, the L 112, is a 3-way bookshelf speaker system designed in "mirror-imaged" pairs for greater stereo imaging. The L 112 features include a one-inch dome radiator, a five-inch midrange driver and a 12-inch woofer. A high-resolution dividing network provides smooth transition between the drivers. The 12-inch woofer uses a *Symmetrical Field Geometry* (SFG) flux-



CIRCLE 121 ON FREE INFORMATION CARD

stabilized magnetic structure. The driver is equipped with a 10 1/4-pound magnet and a 3-inch copper-edgewound voice coil to offer high-power handling, low distortion, and good transient response. The L 112 can be driven by an amplifier with as little as 10 watts or as much as 300 watts continuous sinewave per channel. The enclosure is constructed of wood panels finished in black walnut with a three-dimensional brown grille. Measures 24 1/2 X 14 1/4 X 13 inches. Suggested retail price is \$450 for each speaker.—James B. Lansing Sound, Inc., 8500 Balboa Blvd., Northridge, CA 91329.

UNIVERSAL COUNTER, model 412, is a panel-mount, 8-digit counter/timer measuring 3 X 2 X 0.5 inches in a red acrylic case that requires no panel cut-out for front mounting; only a 3/8-inch diameter hole is needed.



CIRCLE 122 ON FREE INFORMATION CARD

The model 412 has eight bright .35-inch LED's in addition to the LSI IC, a few discrete components, and two micro DIP switches that are

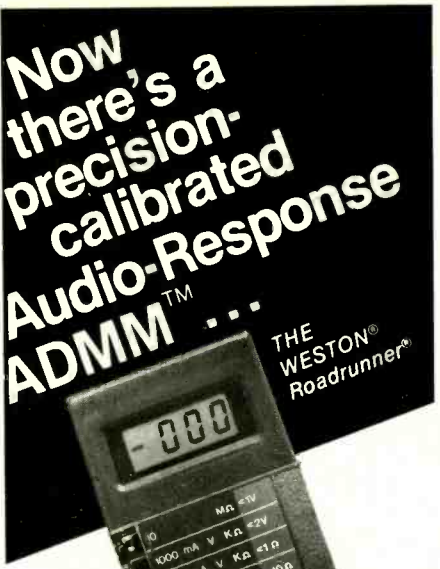

THE FIRST AND ONLY TRULY QUANTITATIVE, 6-FUNCTION, 29 RANGE, PRECISION-TONE ADMM: The Weston Model 6100 Roadrunner® features a highly audible, precision-calibrated function tone that operates on both volts and ohms modes. The unique character of this tone makes the Audio Response Mode a full-function testing aid for quick and accurate troubleshooting in the field. And its 3 1/2 digit, reflective-LCD display eliminates the "washout" in bright light common to standard LCD displays.

The Roadrunner saves time, boosts productivity and accuracy by giving error-free quantitative measurements of dozens of parameters not measurable by ordinary hand-held DMMs.

- ✓ SORT RESISTORS
- ✓ CHECK CAPACITORS
- ✓ CHECK FOR CONTINUITY
- ✓ TEST TRANSISTORS
- ✓ CHECK LOGIC LEVELS.

Want full data? A demo? A dozen to start? Write to the:
Weston Literature Center
614 Frelinghuysen Avenue
Newark, N.J. 07114
We'll rush literature and the location of our nearest distributor.



CIRCLE 45 ON FREE INFORMATION CARD



NOW YOU CAN BUILD YOURSELF AN ORCHESTRA

The most advanced — most versatile organ you ever dreamed of is now within most everyone's reach . . . because you build it yourself the exclusive WERSI way.

Expand your instrument according to your taste and budget. With WERSI's 'Building Block' system, you'll never need to trade organs again!

Superior WERSI quality also available in pianos, synthesizers, amps, rhythm units, etc. . . . kit or factory assembled.

Send \$6 for the exciting Sight and Sound package everyone raves about. You'll receive the famous "WERSITIME 2" 12" LP with accompanying libretto as well as a full color, 104 page manual, widely acclaimed as the encyclopedia of organ builders, introducing you to the Wonderful World of

WERSI world leader in quality do-it-yourself instruments

WERSI ELECTRONICS, INC. Dept. M4
P. O. Box 5318, 1720 Hempstead Road
Lancaster, PA 17601

Please send above demo pack @ \$6.00.

Name _____

Address _____

City _____ State _____ Zip _____

FREE



Burglar Alarm Catalog

Learn how to protect yourself and your possessions. Complete security catalog offers more than 1600 items ranging from simple magnetic door switches and bell systems to the most sophisticated radar, ultrasonic and infrared detectors. Catalog is designed for alarm installers, businesses, government agencies and do-it-yourselfers who demand the highest quality equipment.

MOUNTAIN WEST, Dept. RE-9
4215 N. 16th St., Phoenix, AZ. 85016

Please send me your FREE color product catalog.

Name _____

Address _____

City _____ State _____ Zip _____

or call toll free 1-800-528-6169

CIRCLE 60 ON FREE INFORMATION CARD

accessible to the operator. Frequency, frequency ratio, time interval, period, or events are selected by one of the switches. Gating times of 0.01, 0.1, 1, and 10 seconds or external are selectable through the second switch. Frequency response of 0-10 MHz is standard in all functions except frequency ratio, where it is limited to 2 MHz. Hold and reset inputs are available as standard connections, with others on request.

The power requirements are 5-volts DC at 180 mA, or 120/240-volts AC at 50-60 Hz when the wall-mount plug-in power pack is ordered. Applications include either portable or panel-mount rate indicator, frequency monitor, process timing, period measurement, event counter, frequency comparator, and others. Sealed units with dedicated function and gating time are available for use in harsh surroundings.

The price of the *model 412* is \$175.00 for the standard unit; \$225.00 for the sealed unit.—**International Microtonics Corporation**, 4016 E. Tennessee Street, Tucson, AZ 85714.

REINFORCER RINGS, designed to protect flexible disks and minidisks, prevent hole tearing and help reduce coating removal and rippling damage that causes premature flexible-disk failure. Made of heavy-duty Mylar, the rings are especially rec-

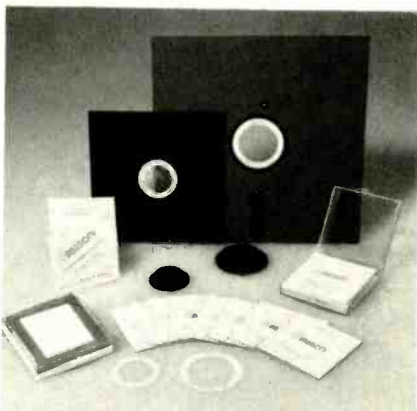

CIRCLE 123 ON FREE INFORMATION CARD

ommended for use with Wang and other drives which require reinforced flexible disks. The *Reinforcer Ring Kit* contains 50 adhesive-backed rings, an easy-to-use applicator, and instructions. Re-order packages of 50 rings are also available. Price of the kit is \$9.95. Refills are \$6.95.—**MISCO, Inc.**, 963 Holmdel Rd., Box 399, Holmdel, NJ 07733.

CASSETTE DECK, *model TCD-420A*, is a two-head metal-tape compatible record/playback deck. The combination of the *Actilinear* Recording System, the *DNYEQ*—the dynamic recording-

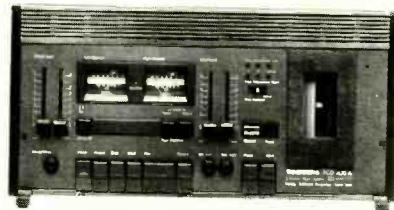

CIRCLE 124 ON FREE INFORMATION CARD

equalization system, plus the Diamond Cut Multicore Senalloy record/playback head provides the higher saturation limit required for new metal tapes. The *TCD-420A* also features a 3-motor, servo-controlled dual-capstan transport system, dual-scale peak-reading equalized meters, plus horizontal, vertical, or wall-mount operation. Suggested retail price is \$850.—**Tandberg of America, Inc.**, Labriola Ct., Armonk, NY 10504.

DIGITAL MULTIMETER, *model 274*, is a handheld instrument with a 3½-digit liquid crystal display. It measures AC and DC volts, DC current,

and resistance in 21 ranges. The *model 274* features single-chip LSI logic, automatic decimal point and overload-protection, and operates up to 200 hours from a single 9-volt transistor battery. An automatic LO-BAT indicator warns the user when the battery life is down to 20%. Accuracy is

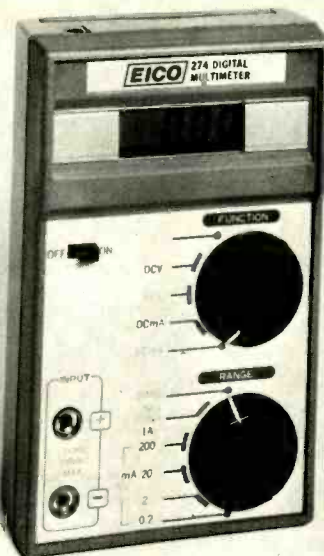

CIRCLE 125 ON FREE INFORMATION CARD

better than 0.8% and input impedance is 10 megohms. The *model 274* comes with 9-volt battery, deluxe test probes, spare fuse, and carrying case; it is priced at \$89.95.—**EICO Electronic Instrument Co., Inc.**, 108 New South Road, Hicksville, NY 11801.

SPEAKER AMPLIFIER SWITCHER, *model MP-3*, allows up to four pairs of stereo loudspeakers to be driven from a single amplifier without overloading the amplifier's output stage. Each pair of speakers may be volume-controlled independently of the others, without changing the load impedance "seen" by the amplifier. Input switching for two separate power amplifiers is provided so that any loudspeaker pair may be driven from either of two signal sources.



CIRCLE 126 ON FREE INFORMATION CARD

The *model MP-3* uses constant-impedance "L pads" as the control elements, instead of the variable resistors that are usually used for that purpose. Though more costly than variable resistors, the L pads provide a minimum load impedance of 4 ohms, resulting in more stable operation of the driving amplifier and allowing extension loudspeakers to be turned up, down, or off without altering the volume of the main speaker pair.

The *model MP-3* will accept power inputs from any commercially available amplifier, and will drive loudspeakers of any nominal impedance in any combination up to a level of 70 watts per speaker. It is packaged for home or office in a metal case of black painted finish and measures 9¼ × 3 × 7½ inches. It is also available in a rack-mount version, as *model MP-3R*, for professional installations, with dimensions of 19 × 3¼ × 7½ inches.

The *model MP-3* is priced at \$149.95; the rack-mounted *model MP-3R* costs \$159.95.—**Russound/FMP, Inc.**, Box 2369, Woburn, MA 01888. **R-E**

NEW BOOKS

For more details use free information card inside back cover

Z80 ASSEMBLY LANGUAGE PROGRAMMING, by Lance A. Leventhal. Osborne & Associates, Inc., 630 Bancroft Way, Berkeley, CA 94710. 608 pp. 5 1/4 X 8 in. Softcover. \$9.50.

This book provides a comprehensive discussion of the Z80 microprocessor assembly language. It assumes that the reader is already familiar with *An Introduction to Microcomputers; Vol 1—Basic Concepts* (particularly Chapters 6 and 7), and does not discuss the general features of computers, microcomputers, addressing methods, or instruction sets.

Features included in the present volume are sample programming problems (more than 80); problem solutions in source code and object code; full explanations of each Z80 instruction; complete Z80 instruction set reference tables; Z80 assembler conventions; Z80 I/O devices and interfacing methods, and comparisons of Z80 and 8080/8085 instruction sets and interrupt structure.

CIRCLE 131 ON FREE INFORMATION CARD

MICROSOFT BASIC, by Ken Knecht, dilithium Press, P.O. Box 92, Forest Grove, OR 97116. 158 pp. 5 1/4 X 8 1/2 in. Softcover. \$9.95.

This is a book that describes the BASIC programming language. After an initial explanation of BASIC and a chapter on definitions, the author presents a complete course on programming in Microsoft BASIC. The examples given, starting with the simplest, are all workable ones.

Subjects covered include branching and loops, arithmetic in BASIC, strings, editing, arrays and files, the disk, additional useful features, and a description of the Radio Shack Level II BASIC. There are four appendices, the third of which illustrates error messages and how the computer informs the user that something is amiss.

CIRCLE 132 ON FREE INFORMATION CARD

THE PERSONAL ELECTRONICS BUYERS GUIDE, by Charles J. Sippl & Roger J. Stippel. Prentice-Hall, Inc., Englewood Cliffs, NJ 07632, 338 pp. 6 1/4 X 9 1/4 in. Softcover. \$8.95.

Covering the entire range of present electronic devices this is a definitive source of price and operating information that goes into the capabilities and limitations of each.

Personal computers, electronic games, TV devices (including those that edit out commercials), home security systems, burglar and fire detection systems, solar energy devices—all the above and more are covered in this consumers' manual which tells both what you want and need to know.

CIRCLE 133 ON FREE INFORMATION CARD

MODERN CB RADIO SERVICING, by Marvin Hobbs. Hayden Book Company, Inc., 50 Essex St., Rochelle Park, NJ 07662. 176pp. 7 1/4 X 9 1/4 in. Hardcover. \$6.95.

Japan is the source of most CB transceivers, but most CB test equipment is produced in the USA. The present book explains the considerable range of the latest service equipment that is produced to meet the requirements of technicians and CB service people. An introductory chapter deals with both first and second-generation 40-channel transceivers as well as the 80-channel SSB transceivers and transceivers for use in other countries. Also covered farther on are the newest trends in transceiver design, including the PLL and microprocessor control techniques. Circuitry of all types is described and illustrated with diagrams.

Specialized test equipment, designed to reduce the time required for repair jobs, is explained; and in the chapters dealing with troubleshooting, the techniques described are applicable to either 40-channel or 23-channel transceivers.

There is a chapter on making initial tests in troubleshooting, and another spelling out the most commonly encountered symptoms and the procedure in handling them. Another chapter is devoted to RF interference and noise elimination. The book includes an appendix with diagrams of various crystal combinations in 23-channel transceivers with multichannel synthesizers.

CIRCLE 134 ON FREE INFORMATION CARD

DC POWER SUPPLIES: APPLICATION AND THEORY, by Robert J. Traister. Reston Publishing Company, Inc., Reston, VA 22090. 234pp. 6 X 9 1/4 in. Hardcover. \$16.95.

The first part of this handbook, devoted entirely to DC power supply, theory, and associated circuits, includes power supply circuitry, power supply components and ratings, dynamic regulation, electronic regulation, protective circuits, voltage multiplication, metering, and safety circuits.

Each chapter in the book ends with a set of study questions, the answers to many of which you must deduce from the text. They are not there explic-

for the 1981
formula-1™

the antenna specialists co. presents the latest advance in high-performance antennas for professional CB communications ... and major support for REACT ❄

Formula cars and our new Model M-710 *Formula-1* share an identical engineering strategy: continually refine a proven basic design with one objective: MAXIMUM POSSIBLE PERFORMANCE.

That's *Formula-1*—direct descendant of A/S's classic base-loaded mobile police antennas. Born for performance, built to last, *Formula-1* is the result of over 25 years of continuous development. Today's new state-of-the-art in mobile CB antennas.



- Precision-wound, water-proof coil. Lifetime burnout guarantee.
- Factory tuned: set-screw ultra-fine tuning.
- Longer whip for more "reach".
- Tapered stainless steel whip minimizes range-robbing wind deflection.
- Anti-static whip ball-tip.
- New quarter-turn quick-disconnect life tested over 2,500 times.
- Easy to install. 17' pre-assembled cable, miniature in-line connector, contour-forming protective mounting gasket, hardware for both roof-top or trunk-lip mounting.
- 5-year limited warranty.

the antenna specialists co.



a member of The Allen Group
12435 Euclid Avenue, Cleveland, Ohio 44106
Export: 2200 Shames Drive
Westbury L.I., New York 11590
Canada: A.C. Simmons & Sons, Ltd.

❄ *Formula-1* contributes more than just performance:

To encourage CB for serious highway communications, we're donating \$1.00 to REACT International for every *Formula-1* purchased in 1981. Join REACT. Get involved. Ask your dealer.



CIRCLE 65 ON FREE INFORMATION CARD

Would you pay \$20 a month for a highly skilled technician?

Here's your opportunity!

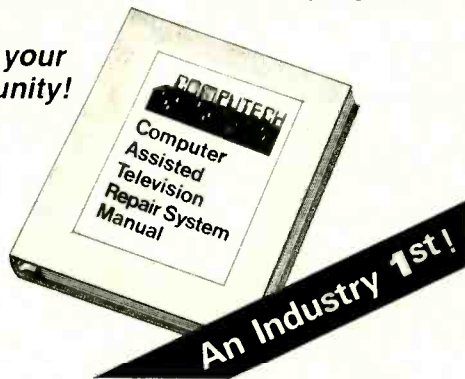

Our exclusive COMPUTECH manual is an organized, easily accessible source of solutions to those frustrating "tough-dog" service problems. Most importantly, this manual is expanded and updated each month to keep you in step with the rapidly changing television industry.

COMPUTECH can save hours of frustrating and unprofitable diagnostic time!

- approximately 6500 symptoms and solutions to "tough-dog" problems.
- indexed numerically by SAMS number.
- symptoms listed alphabetically for faster access.
- monthly updating provided.
- contains step-by-step procedures to locate the most difficult problems.
- standardizes your trouble shooting techniques.
- excellent training aid.
- saves YOU time and guesswork.

Over the past two years "COMPUTECH" has combined hundreds of hours of experience by professional technicians with the unique advantage of a computer to produce an attractive, easy to read, 8½"x11" binder that contains the type of information needed to make TV servicing faster, easier, and more profitable.

**COMPUTECH — AT TODAY'S PRICES...
YOU CAN'T AFFORD NOT TO!**

COPYRIGHT © 1980

Call us direct (801) 277-2655
or mail this coupon today.

COMPUTECH		RE
4685 Holladay Blvd.		
Salt Lake City, Utah 84117		
Phone (801) 277-2655		
Due to the importance of its monthly updating, COMPUTECH can only be obtained on a subscription basis at \$240 a year.		
Enclosed is _____ check. _____ money order. or _____ C.O.D. requested.		
Name _____		
Service Company _____		
Address _____		
City _____ State _____ Zip _____		



CIRCLE 62 ON FREE INFORMATION CARD

itly; but figuring them out will show your level of comprehension of what you have read.

The second part discusses the actual circuits, and among the topics discussed are low voltage supply circuits, medium voltage supplies, high voltage supplies, and DC-to-DC supply curcuietry. There are over 80 schematics and drawings.

CIRCLE 135 ON FREE INFORMATION CARD

PROBLEMS FOR COMPUTER SOLUTION, by Stephen Rogowski. Student Edition. Creative Computing, PO Box 789-M, Morristown, NJ 07960. 104pp. 8¼ X 10½ in. Softcover. \$4.95.

This is a book of exercises in computer use for high school and college students, as well as for self-learners of any age. The 90 problems presented for computer solution cover such areas as arithmetic, algebra, geometry, trigonometry, number theory, probability, statistics, calculus, science, and general problems. The student is also given an opportunity to try his or her hand at three of the famous unsolved problems in mathematics.

There are no answers to the problems given in the Student Edition; those are to be found in the Teacher's Edition. Those who want to take up the challenge this volume offers on their own will have to obtain both editions.

CIRCLE 136 ON FREE INFORMATION CARD

ALL ABOUT TELEPHONES, by Van Waterford. TAB Books, Blue Ridge Summit, PA 17214. 190pp. 5¼ X 8½ in. Softcover \$4.95.

It is now possible for you to own your own telephone system, rather than rent the equipment from the telephone company. After one chapter briefly relating the history of the telephone, and another on how it works, this book tells what kind of private telephone systems exist, how they work, how to build each kind, and what legally you may and may not do with them. You'll also learn what regulations apply to the telephone company and the manufacturers of private telephone systems.

The author describes an astonishing variety of new telephones and telephonic devices, including the picturephone, the electronic telephone, the speaker phone, and cordless telephones. There's also a chapter on telephone security devices, such as voice-scramblers, wire-tap debuggers, and the voice stress analyser system. There are two appendices: I: Glossary, and II: List of Suppliers. The book is well filled with diagrams and the material is presented crisply and clearly.

CIRCLE 137 ON FREE INFORMATION CARD

MORSE, MARCONI, AND YOU: UNDERSTANDING AND BUILDING TELEGRAPH, TELEPHONE AND RADIO SETS, by Irwin Math. Charles Scribner's Sons, 597 Fifth Avenue, New York, NY 10017. 79pp. 7¼ X 9¼ in. Hardcover. \$8.95.

For young hobbyists, this little book explains the basic principles of electricity clearly and shows the experimenter how to build working telegraph sets, telephones, and radios using the same materials that the great inventors of those devices used: wood, tin cans, and bell wire. Following clearly put directions, the experimenter will not only be able to build devices that work, but will learn in the process exactly *why* they work as they do. The few components that will have to be purchased can be bought cheaply.

Each construction program leads inevitably to another, slightly more complicated one. When the experimenter has done all the projects offered here, he or she will have a solid foundation in electronics as well as skill in a fascinating and constructive hobby.

CIRCLE 138 ON FREE INFORMATION CARD

THE BUGBOOK IV: MICROCOMPUTER INTERFACING USING THE 8255 PPI CHIP WITH EXPERIMENTS, by Dr. Paul Goldsbrough. Howard W. Sams & Co., Inc., 4300 West 62nd St., Indianapolis, IN 46268. 224pp. 5¼ X 8½ in. Softcover. \$8.50.

This book details the major microcomputer input/output techniques and their implementation with the 8255 Programmable Peripheral interface (PPI) IC. When the techniques are mastered, the same principles can be applied to other PPI IC's. The full range of operation modes is detailed, including data transfer process, flag testing, bit testing, etc.

Experiments are presented with each chapter, and range from the simple input and output ports through the more complicated master-slave micro-processor configurations.

CIRCLE 139 ON FREE INFORMATION CARD

AUDIO AND VIDEO INTERFERENCE CURES, by Larry Kahaner, Hayden Book Company, Inc., 50 Essex Street, Rochelle Park, NJ 07662. 128pp. 5¼ X 8¼ in. Softcover \$5.50.

This book provides all the information needed to deal with noise sources of all types. There are step-by-step instructions on how to find the source of interference and put it under control. Also included are schematic wiring diagrams of filters for all types of receivers and transmitters. They include simple filter diagrams to eliminate radio and TV interference caused by noisy home appliances, neon lights, and motors. For those who have an especially difficult interference problem, the final chapter supplies a list of outside resources that can be helpful.

R-E

CIRCLE 140 ON FREE INFORMATION CARD

American Cancer Society
2,000,000 people fighting cancer.

STATE OF SOLID STATE

continued from page 72

tional, there's enough dead time between digits to allow multiplexing gas-discharge displays.

We've breadboarded a little circuit (Fig. 1) to exercise these IC's. The circuit simply displays what is entered on the keyboard. Each time an entry is made, the display shifts one digit to the right and the new entry appears in the left-most display digit. The circuit accepts keyboard data entry, encodes it to binary, and counts digits (we cheated, the circuit accepts 8 key strokes but we only drive 6 digits; so after the 6th digit, two more key strokes are required before we reload the first digit). The circuit provides the data to the display controller, limits current to the segments, and uses 2N2222's as digit drivers. We used a 7805 (or a LM340-T5.0) to regulate the voltage at 5.0 DC from our 9-volt battery supply.

The *Digitran* 4 × 4 16-key keyboard provides a path from the row-output pin (there are four) to the column-output pin (of which there are also four) when a key at any row-column intersection is pressed. This data is encoded by the 74C922 into a 4-bit binary code. The data available strobe is used three times: first, via an inverter, to enable the output of the 74C922; second, through a second inverter, to advance the count of the three least-significant stages of 4024-type 7-stage binary counter; and third, without any inverter, to drive the write enable control of the 74C912. The 74C912 drives 6 digits of a 6-digit LED counter through 2N2222 drivers. Segment currents are limited through 1000-ohm resistors.

Note that the 4024 Q_n outputs are inverted before driving the 74C912 address lines. If they were not inverted, digits would load from right to left. Five sections of a 4069-type hex inverter are used. R-E

MICROWAVE DEVICES

continued from page 64

21-c). If we plot the power (i.e., product of Figs. 21-a and 21-c), then we will obtain the power-vs-time waveform of Fig. 21-d. Notice that, for substantial periods during the cyclic excursion, the power is negative—meaning that the device is oscillating and will deliver energy to the external tank circuit. There is only a brief period in which the terminal current and terminal voltage are both positive and that will limit the efficiency of the BARITT oscillator.

The BARITT device is a low-power microwave energy source, and is considered superior to the Gunn device for many applications. R-E

DON'T FORGET

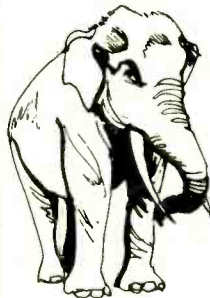

USE
YOUR
READER
SERVICE
CARD

For faster service

USE ZIP CODE

on all mail

From HAMEG...

HM307



\$405

The first portable scope with a component tester.

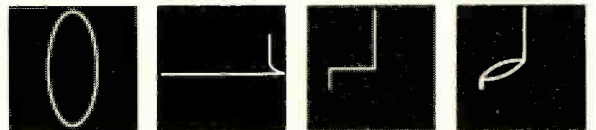

Capacitor 33 μ F Transistor E-C Transistor B-E B-E 1 μ F + 68 ohms

Oscilloscope Specifications:

Y Deflection

Bandwidth: DC - 10 MHz (-3 dB)
Overshoot: Less than 1%
Sensitivity: 5 mV - 20 V/cm
Input Imp: 1 M ohm // 25pf

X Deflection

Timebase: 0.2s - 0.2 μ s/cm
Triggering: 2 Hz - 30 MHz (3mm)
Auto + level control
Bandwidth: 2Hz - 1 MHz

General Information

Component Tester:	For single components and in circuit
Calibrator:	0.2V \pm 1% for probe alignment
Power Supplies:	Regulated including high voltage
A.C. Input:	110, 127, 220, 237, V.A.C., 50 - 60 Hz
Weight:	8-1/4 Lbs.
Size:	4-1/2" H x 8-3/8" W x 10-7/16" D

For further information on HAMEG's full line of top performance oscilloscopes, contact:

HAMEG, INC.

88 Harbor Rd, Port Washington, N.Y., 11050
Telephone: 516-883-3837

Bearcat® 210XL Super Scanner

Look what you get with the Bearcat 210XL. Exciting, new space-age styling. No-crystal, pushbutton tuning. New, 18 channel, 6-band coverage of over 6000 frequencies. And features like 2 scan speeds. Automatic Squelch, Search, and Lockout. Direct Channel Access. Selective Scan Delay. And much more. There's never been a Scanner like the Bearcat 210XL.



"TAKE IT FROM A SMART OPERATOR."

Don Adams

BEARCAT 210XL SCANNER \$229.

Add \$7.00 per scanner for U.P.S. ground shipping in the continental U.S. Send your cashier's check or money order to our address below or order by phone if you have a Visa or Master Charge card.

COMMUNICATIONS ELECTRONICS™

854 Phoenix □ Box 1002 □ Ann Arbor, Michigan 48106 U.S.A.
Call TOLL-FREE (800) 521-4414 or outside U.S.A. (313) 994-4444

CIRCLE 68 ON FREE INFORMATION CARD

A Classroom In Your Mailbox!

STUDY
Two-Way Radio

THROUGH THE
REVISED

MTI

Home Study Course

Send coupon below for free course outline
No obligation - No salesman will call

Professional Training in a Unique Career Field

Providing Training to the Industry Since 1960

study FM two-way radio at home!

I am interested in learning more about professional FM two-way radio. Please send me full details on the MTI training program.

Name _____

Address _____

City/State/Zip _____

MTI

C3J

Mobile Training Institute

Box 735, Camp Hill, PA 17011-U.S.A.

CIRCLE 70 ON FREE INFORMATION CARD

NEW LIT

For more details, use free information card inside back cover

MICROPROCESSOR PRODUCT GUIDE, No. *MPG-180C*, contains 60 pages describing all the elements needed to build a microprocessor system. It covers the complete line of IC's, support systems, and accessories that make up the *COSMAC* microprocessor family. The guide describes the *CDP1802* microprocessor and contains data for a wide variety of RAM's, ROM's, I/O and interfacing devices. Basic descriptions, characteristics, and functional and terminal diagrams for other general-purpose memory IC's are also presented. Other features of the guide are a cross-reference guide listing RCA types equivalent to other manufacturer's devices and an index to the line of manuals and application notes on the *COSMAC* system.—**RCA Solid State Div.**, Box 3200, Somerville, NJ 08876.

CIRCLE 141 ON FREE INFORMATION CARD

HIGH-VOLTAGE COMPONENTS GUIDE, is a six page two-color brochure describing components used as replacements in color television sets. It is designed to provide comprehensive product data to electronic parts distributors, service dealers, and technicians. It contains sections on high-voltage multipliers including a variety of tripler and quadrupler devices, high-voltage rectifiers and resistive divider/focus assemblies. Circuit diagrams and package outlines are also given. 31 solid-state devices are cross referenced in the brochure to 615 industry part numbers listed in alphanumeric order.—**Sylvania/Philips Electronic Components**, 1025 Westminster Dr., Williamsport, PA 17701.

CIRCLE 142 ON FREE INFORMATION CARD

WATTMETER/ANALYZER BROCHURE, No. *PA4381-1179*, is a full-color 4-page guide introducing a series of multipurpose digital RF directional wattmeters. The microprocessor-based model 4381 RF Power Analyst offers measurement of several signal parameters in addition to bi-directional power from 0.5 to 2300 MHz and 0.1 to 10,000 watts. The brochure features application of VSWR, return loss, % modulation, dBm, and peak envelope power functions. Also described are a delta display and min/max memory on any of the displayed quantities. Full specifications are included.—**Bird Electronic Corp.**, 30303 Aurora Rd., Cleveland, OH 44139.

CIRCLE 143 ON FREE INFORMATION CARD

ELECTRONIC SURPLUS CATALOG, contains 40 pages of brand-name merchandise at bargain prices. Items such as AM/FM stereo car radios, AM tape-deck stereos, Hi-Fi speaker-system kits, car alarms, telephones, microwave timer boards, TV games, and computers are all offered at low prices. Other electronic items such as relays, batteries, capacitors, heat sinks, IC's, semiconductors, switches, and many more, are also included in the catalog.—**B & F Enterprises**, 119 Foster St., Peabody, MA 01960.

CIRCLE 144 ON FREE INFORMATION CARD

PRECISION TOOL CATALOG, No. *FL-979*, is a 24-page compact flier of tools designed for electronics, telecommunications, and aerospace for use in maintenance and production departments. The flier features over 500 various spring adjusters, tension and thickness gauges, burnishers, tool kits, and precision hand tools. It also shows a line of wire wrapping and unwrapping tools, and contact connector insertion and removal tools.

Included is a price list of the products.—**Jonard Industries Corp.**, Precision Tools Dept., 134 Marledale Rd., Tuckahoe, NY 10707.

CIRCLE 145 ON FREE INFORMATION CARD

MAGNETIC TAPES BOOKLET, *Sony Magnetic Tapes*, is a four-color 11-page brochure explaining different tape formulations and their recommended applications. It offers information on how the raw materials are selected and combined to create a variety of tape formulations and also explains how the tape, cassettes, reel transport mechanisms, and winding tension are prepared for final assembly. There are separate sections on each of the six types of tape which include cassettes, open reel, 8-track, microcassettes, and videotape cassettes. Complete technical information is provided for each tape, including length, bias and equalization settings, and frequency response. A selection chart is also offered.—**Sony Magnetic Tape Div.**, **Sony Industries**, 9 W. 57th St., New York, NY 10019.

CIRCLE 146 ON FREE INFORMATION CARD

SWITCH BROCHURE, *Tini DW Multi-Switch Switches*, *NPB-349*, is a full-color 8-page brochure describing those subminiature switches with 10 and 15 mm centers. The brochure covers the basic-design features of the switch, plus the switching functions, material specifications, and terminations. Special features such as available pushbuttons and legends are also covered. These nonilluminated switches are used in analog and digital computers, analyzers, transmitters and receivers, and intercoms, and are available in up to 18 stations in a single row. Ordering information is included.—**Switchcraft, Inc.**, 5555 No. Elston Ave., Chicago, IL 60630.

CIRCLE 147 ON FREE INFORMATION CARD

CONNECTOR CATALOG, *Adapta-Con Catalog ACBP-6*, 18 pages, offers information on UBS and UBC series crimp contacts. The catalog contains 10 photographs and 30 drawings of the connectors and features standard information for material and finishes, mechanical features and electrical data. It also includes instructions on how to order unshrouded headers, which electrically connect rigid PC boards with UBC crimp housing or ribbon-cable socket connectors.—**ITT Cannon Electric**, 666 E. Dyer Rd., Santa Ana, CA 92702.

CIRCLE 148 ON FREE INFORMATION CARD

COMPONENTS AND TEST EQUIPMENT, *Catalog No. 21*, is a 30-page, 2-color catalog offering products from leading manufacturers. Included is a wide selection of IC's and transistors, along with a listing of their ECG equivalents. Other products offered are capacitors, tape heads, test cassettes, soldering equipment, wire and cable, lamps and fuses, LED's and crystals, power supplies, and test equipment that includes oscilloscopes, signal generators, and DMM's. Technical specifications for the products are provided along with pricing and ordering information.—**Ora Electronics**, 7241 Canby Ave., Reseda, CA 91335.

CIRCLE 149 ON FREE INFORMATION CARD

UHF & VHF RADIO MODULES CATALOG is a pocket-sized guide containing 24 pages of kits and assembled units for transmitting and receiving converters, FM receivers, receiver preamps,

FM exciters, linear power amplifiers, adapters, test probes, and accessories. Photos, features, specifications, and connection diagrams are offered for the products. Pricing information and order form are included.—**Hamtronics, Inc.**, 65 Moul Rd., Hilton, NY 14468.

CIRCLE 150 ON FREE INFORMATION CARD

SHORTWAVE NEWS BULLETIN, the *DX Journal*, 32 pages, is a bi-monthly news bulletin devoted to the DX listening hobby, and contains technical and general interest articles. It includes news items from around the world and around the bands, a DX hotline, technical reviews, and equipment reports. Subscription price for one year is \$7.00. Sample copy is \$1.00.—**World Shortwave Listeners' Club**, 80 Hartsdale Ave., White Plains, NY 10605.

COMPUTER BOOKS CATALOG, 16 pages, is a fully illustrated catalog covering 61 titles on basic and advanced instructional books, dictionaries and reference works, plus books on language, programming and interfacing, technical circuitry, microcomputers, software debugging, computer graphics programming, and much more. Expanded descriptions are provided for these new titles—*Microcomputer Primer*, 2nd ed., the *Howard W. Sams Crash Course in Microcomputers*, and the *Computer Dictionary and Handbook*. Also included are *6502 Software Design*, *8080/8085 Software Design*, and the *Computer Graphics Primer*. The catalog has alphabetical and numerical indices to the contents which helps speed its use, and also features a completely new authors' index in which 29 computer-book authors, their positions, education, and experience in the field are described.—**Howard W. Sams & Co., Inc.**, 4300 W. 62nd St., P.O. Box 558, Indianapolis, IN 46206.

CIRCLE 151 ON FREE INFORMATION CARD

COMPONENTS CATALOG, *Industrial Catalog No. 030*, 344 pages, features more than 75 product lines and provides complete descriptions, technical specifications, and pricing. Special emphasis is placed on test equipment which includes oscilloscopes, multimeters, frequency counters, generators, logic probes, VOM's, and many more. Other products covered include printed-circuit equipment, tools, transformers, semiconductors, resistors, capacitors, switches, relays, hardware, wire and cable, fuses and lamps, plus many others. The catalog also provides a 32-page technical-data handbook which includes the most frequently needed electronic tables, symbols, and formulas. Catalog is available for \$2.00.—**Joseph Electronics, Inc.**, 8830 N. Milwaukee Ave., Niles, IL 60648.

THERMISTOR CATALOG, *Iso-Curve Catalog L-2B*, 16 pages, covers a line of standard Iso-Curve, R-T, Curve-Matched interchangeable thermistors. Specific technical data on the entire line is included. The catalog provides the latest thermistor state-of-the-art information on bead and glass probe interchangeable thermistors that are precision curve-matched to standard resistance temperature curves to an accuracy of within $\pm .25^{\circ}\text{C}$, $\pm 0.5^{\circ}\text{C}$ or $\pm 1.0^{\circ}\text{C}$. Also offered are R-T tables for each standard unit, resistance tolerance vs. temperature tolerance curves, a temperature range and design configuration availability table, half-degree increment standard R-T temperature characteristic curves, a standard part number index for standard glass probes, mini-probes, standard bead, and small bead thermistors, typical *Iso-Curve* thermistor probe assemblies, and more.—**Fenwall Electronics**, Sales & Application Engineering Dept., 63 Fountain St., Framingham, MA 01701.

CIRCLE 152 ON FREE INFORMATION CARD

OSCILLOSCOPES, *Catalog No. 449-16*, is a 16-page bulletin featuring a line of portable oscilloscopes and includes instruments for a broad range of applications—from educational and service use to laboratory and digital circuit measurements. A description, photograph, and specifications are included for each instrument. Among

the instruments detailed are 15-MHz dual trace and true dual-beam oscilloscopes, a 25-MHz scope with signal delay, a 30-MHz unit with variable trigger delay, and 60-MHz and 100-MHz scopes with third-channel trigger view and hold-off. Also described is the OS4000 digital-storage scope which features roll-mode viewing, T-Y and X-Y display, trigger-window control, and a 1K X 8-bit memory.—**Marketing Communications, Gould, Inc., Instruments Div.**, 3631 Perkins Ave., Cleveland, OH 44114.

CIRCLE 153 ON FREE INFORMATION CARD

TEST-EQUIPMENT CATALOG, *Electronic Measurement Instrumentation*, is an 86-page guide that offers background and technical information and selection guides for different types of test instruments including digital multimeters, electrometers, picoammeters, nanovoltmeters, voltage and current sources, milliohmeters, and test systems. Various models in each group are described, along with photographs, main features, and technical specifications. Various accessories are also described. Included is a model number and product-description index.—**Keithley Instruments, Inc.**, 28775 Aurora Rd., Cleveland, OH 44139.

CIRCLE 154 ON FREE INFORMATION CARD

ELECTRONICS ACCESSORIES, *Catalog C-29*, is an attractive 44-page two-color guide covering a number of electronics products, along with descriptions, specifications, and illustrations. Items covered include couplers, telephone accessories, personal communications equipment, audio connectors and cables, automotive speakers, multimeters, power supplies, phono cartridges, and many more. Featured are UHF/VHF/CATV/MATV amplifiers, UHF/VHF hybrid splitters, 2- and 3-way crossover networks, electret microphones, and a 2-channel wireless FM intercom system.—**Vidaire Electronics Mfg. Corp.**, 150 Buffalo Ave., Freeport, NY 11520.

CIRCLE 155 ON FREE INFORMATION CARD

HAM ANTENNA CATALOG, *Hygain*, 24 pages, covers over 100 base and mobile antennas, towers, rotators, microphones, headphones, boom mic headsets, and accessories for the amateur radio operator. Featured are a full line of desk and hand microphones, the HDR-300 antenna rotator and a series of seven crank-up antenna towers. Illustrations and detailed specifications on all products are offered, including SWR curves on all base antennas.—**Telex Communications, Inc.**, 9600 Aldrich Ave. So., Minneapolis, MN 55420.

CIRCLE 156 ON FREE INFORMATION CARD



INFLATION IS EVERYBODY'S HEADACHE!

High stability crystals for frequency or time. Use the best.

- CB meters
- 2 meter scanners
- Industry VHF
- Marine VHF
- CB standard
- Amateur Bands
- General Communication
- Micro processor crystals

Send for our latest catalog. Write or phone for more details.

Jan Crystals
P.O. Box 0607
Ft. Myers, Florida 33906
all phones (813) 936-2397

easy to charge

JAN CRYSTALS

CIRCLE 28 ON FREE INFORMATION CARD

ELECTRONIC COMPONENTS

MOUSER ELECTRONICS

112 PAGE FREE CATALOG

MANUFACTURERS OF QUALITY ELECTRONIC COMPONENTS

Battery Clips & Holders
Cable Sets Connectors Capacitors
Displays, LED Fuses Jacks & Plugs
Knobs Lamps Potentiometers
RF Coils Relays Resistors
Switches Semiconductors Speakers
Test Equipment Transformers Tools
Wire & Cable

WE STOCK What We Catalog !

- Sales and Order Desk
- Phone and Mail Orders Welcome
- TERMS: C.O.D., Visa, Master Charge
- Over 10,000 Different Items in Stock
- (Open Accounts Available)

MOUSER ELECTRONICS
11433 WOODSIDE AVE., SANTEE, CA 92071
PHONE: (714)449-2222 T.W.X: 910-331-1175

CIRCLE 61 ON FREE INFORMATION CARD

Radio- Electronics

Copyright © Gerbeck Publications Inc. 1982

**SPECIAL REPRINT
BUILD A BACKYARD SATELLITE TV RECEIVER**

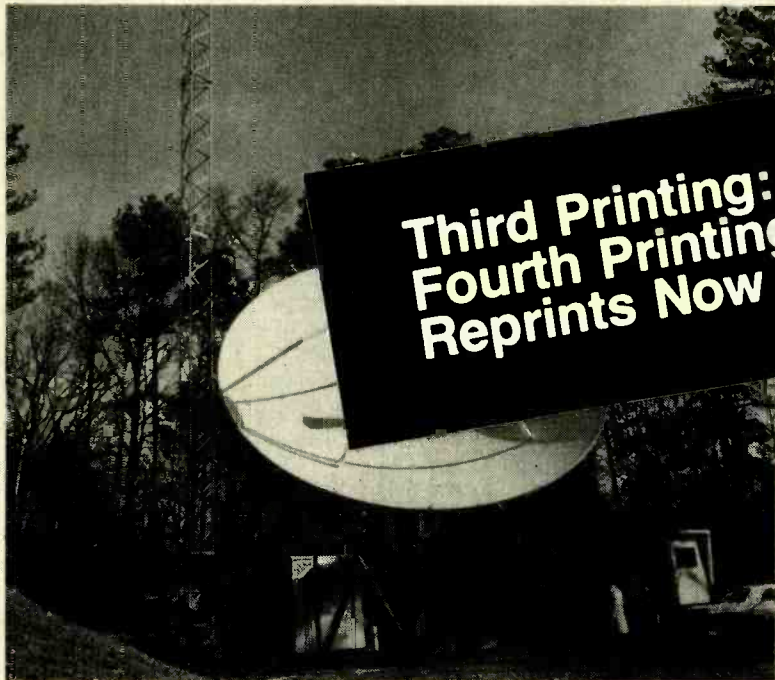

**Third Printing: Sold Out!
Fourth Printing—Just Off Press!
Reprints Now Available!**

Don't miss out again!

Send away today for your 36-page booklet containing a complete reprint of all seven articles in the series on Backyard Satellite TV Receivers by Robert B. Cooper Jr.

This all-inclusive report gives you all the data you need to build your own Backyard Satellite TV Receiver.

- TELLS ALL ABOUT domestic satellite communications, with full details on how you can pull those elusive TV signals from space.
- LEGAL REQUIREMENTS, technical specifications, and how you, the

home constructor, can meet them. Find out what mechanical and electronics skills you need.

■ RECEIVER CHARACTERISTICS, technical details and specifications, along with examples of actual receivers built at comparatively low cost.

■ ANTENNA DESIGN... and exactly how you can build a spherical antenna, while keeping total earth-station cost for the complete system under \$1,000.

■ THE FRONT END is critical when you build your own system. We help you explore several different ap-

proaches to making one that will work for you.

■ RECEIVER-SYSTEM hardware, and how it goes together to bring you direct-from-satellite TV reception in your own home.

To order your copy:

Complete coupon and enclose it with your check or money order for \$6.00. We will ship your reprint, postpaid in U.S. and Canada, within 6 weeks of receipt of your order. All others add \$4.00 for postage. New York State residents must add 48¢ sales tax.

**Radio-
Electronics**

Satellite TV Reprints
45 East 17th Street
New York, N.Y. 10003

RE9 Please print

(Name)

(Street address)

(City)

(State)

(Zip)

I want _____ reprints @ \$6.00 each, postpaid.
I have enclosed \$ _____ N.Y. State residents must
add 48¢ sales tax.

RF GENERATOR

continued from page 69

Finish up this half of the board by installing the IC's. Orient them as shown in Fig. 11. Install the MC1648's first, at IC201, IC202, and IC203. Then install a 74LS00 at IC204, and a 74LS90 at IC205.

Take a breather at this point; then carefully check your work. Correct any mistakes you find before going any farther.

Now for the rest of the board. Start with the voltage regulator IC's. Install an LM317T at IC207 with the tab to the right. Then mount a 7805 (LM340T-5) at IC206. Note that this IC mounts flat against the board, and that no heatsink is required. Use 4-40 hardware to fasten it in place before you solder the leads.

Next mount the rest of the capacitors. Use extra care with them because there are quite a few, and they can wind up in the wrong places. Start by installing a 1000- μ F electrolytic at C216. The "+" lead goes nearest D216. Then install two 0.01- μ F capacitors at C217 and C218. Move up and install a 10- μ F electrolytic at C228, and a 0.1- μ F disc beside it at C226. Install another 0.1- μ F capacitor at C229. Then move up a bit and install a 0.01- μ F capacitor

at C227. After that install a 1- μ F electrolytic at C225, just above. Note that its positive side is to the right. Three 0.01- μ F disc capacitors come next. Install one at C224, another at C222, and the remaining one at C220. Continue with two 0.1- μ F capacitors; one goes at C221 and the other at C223. Finish up by installing a 15-pF unit at C219.

Now, more diodes. First, there are seven 1N4002 rectifiers for the power supply. Install them as indicated at D210 through D216. Then install two more 1N4002's at D219 and D220. *Be careful not to install D219 in D217's place!* Mount the two 1N5231 Zeners as indicated at D217 and D218.

The resistors come next. Install 1K resistors at R213 and R214. Next, install 470-ohm resistors at R216 and R215. Move down the board a bit and install 2.7K resistors at R217 and R218. Then install a 100K unit at R219. Continue by installing a 47-ohm, 2-watt resistor at R224. Note that this must be a carbon composition type, and not wirewound. If you use a wirewound type the RF output will be erratic. Below R224 install a 4.7K resistor at R221, a 1K resistor at R222, and a 10-ohm resistor at R225. Finish up by installing a 680-ohm resistor at R223 near the LM317-T, and a 470-ohm one at R220.

The last component to be installed is

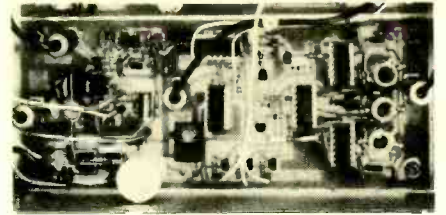

FIG. 12—A HEAT SINK must be used on Q207 (lower left). Also note that IC206 (7805) is secured to the board with 4-40 hardware.

a transistor. Install a 2N2219 at Q207 and slip a small TO-5 heatsink over it.

Carefully check your work. Make sure that the diode and electrolytic capacitor polarities are right, and correct any errors you find. The assembled VCO board is shown in Fig. 12.

You've just completed the Programma-2's most complex board. In the next part we'll finish building the unit and put it to work. **R-E**

Take
stock
in America.



MODEL 215
\$71.50

MODEL 205
\$49.50

MODEL
215 K KIT
\$81.00

MODEL
205 K KIT
\$59.00

MODEL 225
COMBO
KIT
\$130.00



THE NEW

performers.

INJECT-A-PULSE® ... CATCH-A-PULSE® THE DYNAMIC DUO FOR CMOS, MOS, TTL, DTL & μ P TESTING.

These neat shirt-pocket logic probes can quickly and accurately analyze or troubleshoot the static and dynamic conditions of logic circuitry.

The Model 215 INJECT-A-PULSE® probe provides a switchless 10 Nsec. pulse with pulse stretching to 50 Msec. Its high input impedance eliminates loading. Frequency response is better than 50MHz. The proper logic threshold is automatically selected and circuit open detection is provided.

The Model 205 CATCH-A-PULSE® offers a lot of "automatics". Like single pulse or pulse train logic level sensing ... current limiting ... programmed output voltage level ... and input protection to ± 70 VDC.

Probes are furnished complete with a detachable 6 ft. coiled cord with mini-alligator clips, instruction manual and storage case. Kits include a high voltage adapter and coiled cord with microhooks. The COMBO KIT offers the most compact, automatic and economical logic probe team on the market.

For a free, no-obligation demonstration, contact your Triplet Distributor, Mod-Center or Representative.

Triplet performance ... a tough act to follow

 **TRIPLET**

Bluffton, Ohio 45817
Telephone (419) 358-5015
TWX: 810-490-2400

CIRCLE 79 FOR IN-PLANT DEMONSTRATION

CIRCLE 78 ON FREE INFORMATION CARD

www.americanradiohistory.com

market center

CLASSIFIED COMMERCIAL RATE (for firms or individuals offering commercial products or services). **\$1.65 per word prepaid (no charge for zip code)**. . . . **MINIMUM 15 WORDS**. 5% discount for 6 issues, 10% for 12 issues within one year, if prepaid.

NON-COMMERCIAL RATE (for individuals who want to buy or sell a personal item) **\$1.00 per word prepaid**. . . . no minimum.

ONLY FIRST WORD AND NAME set in bold caps. Additional bold face (not available as all caps) at 10¢ per word. All copy subject to publisher's approval. **ADVERTISEMENTS USING P.O. BOX ADDRESS WILL NOT BE ACCEPTED UNTIL ADVERTISER SUPPLIES PUBLISHER WITH PERMANENT ADDRESS AND PHONE NUMBER.** Copy to be in our hands on the 26th of the third month preceding the date of the issue (i.e., August issue closes May 26). When normal closing date falls on Saturday, Sunday, or a holiday, issue closes on preceding working day.

SATELLITE TELEVISION

SATELLITE television...Howard/Coleman boards to build your own receiver. For more information write: **ROBERT COLEMAN**, Rt. 3, Box 58-ARE, Travelers Rest, SC 29690

SAVE \$\$\$! Satellite television manual, source catalogue. Dishes, receivers, complete systems. Design, programming. Illustrations, photos. \$3.95. **WESTCOLONY**, Dept-E, Box 9471, Fresno, CA 93792

SATELLITE equipment catalog. Over 25 of the best manufacturers and suppliers, LNA's, receivers, antennas and complete systems covered in detail. Four different sections. \$12.00. **TMS CO.**, P.O. Box 8369, Roseville, MN 55113

SATELLITE television. Receivers \$300, dishes \$100. LNA's, downconverters. Info catalog \$5.00. **SATELLITE SYSTEMS DEVELOPMENT**. Dept. A4, Box 184, Milpitas, CA 95035

Enjoy Satellite TV Now



Better than Cable TV—Over 200 TV and radio services. Why waste money? Learn the whole story and build a video system the family can enjoy. No commercials, **FREE** movies, sports and Vegas shows—worldwide, crystal clear reception connects to any TV set. Big (8 x 11 in.) book loaded with details, photos, plans, kits—**TELLS EVERYTHING! Satisfaction Guaranteed.** Send \$7.95 TODAY! Add \$2.00 for 1st class (air mail) or call our 24 hour C.O.D. rush order line (305) 862-5068. **GLOBAL ELECTRONICS**, P.O. Box 219-E, Maitland, Florida 32751

SATELLITE VISION

We manufacture the highest spec 3-meter data & video dish in the world 410b gain! We also sell direct. Immediate delivery or you pick up. Complete details including satellite TV information, aiming service and discount schedule. Send \$1.25 for postage & handling. **TIGER TENNA**, P.O. Box 561, Casselberry, Florida 32707



SATELLITE TV

- SYSTEMS • COMPONENTS • LNA's •
- ANTENNAS • RECEIVERS •

WE CAN HELP YOU!

HIGH FRONTIER

2230 E. Indian School Rd., Phoenix, AZ 85016
(602) 954-6008

SATELLITE TV

Make your first investment in satellite TV the intelligent one!
• Complete Handbook & Buyers Guide - detailed yet simple to understand. Includes equipment costs, kits, turnkey manufacturers - \$7.95
• Comp-Sat Location Analysis - 5 page computer print out locates all 11 satellites & must for any station. Send zip code (longitude & altitude or nearest intersection) - \$9.95
• Both of the above for only \$16.95
Send specified amount plus \$2.00 for First Class Mail to
INTERNATIONAL COMMUNICATIONS CO.
P.O. Box 25036 CHARLOTTE, N.C. 28212



CALL TODAY
24 Hour C.O.D.
HOT LINE
(704) 379-0019

Satellite TV

FOR THE HOME

Sick of Network TV?

Our receiver lets you get over 75 channels of television directly from earth-orbiting cable TV satellites: HBO, Showtime, super stations, sports and movies worldwide.

We don't just sell information! We Manufacture Hardware!

technical information book and catalog gives you all the facts. Inexpensive dishes, feeds, telemetry software, kits and more. Recommended reading by NASA, The Office of Consumer Affairs and quality companies like Rockwell/Collins. Send \$7.95 today!



CALL
24-hr. C.O.D. Hotline
(305) 339-7600

SPACECOAST
RESEARCH CORPORATION
P.O. Box 442-E, Altamonte Spgs, FL 32701



From offshore oil rigs, data links to hotels and backyard installations, we wrote the book. Constantly updated, our 94 Page

EDUCATION & INSTRUCTION

PROGRAMMABLE calculator magnetic card program exchange membership \$5.00. **PROGRAM EXCHANGE**, Box 8466, Miami Beach, FL 33139

UNIVERSITY degrees by mail! Bachelors, Masters, Ph'D's . . . Free revealing details. **COUNSELING**, Box 317-RE9, Tustin, CA 92680

ATTENTION ELECTRONIC TECHNICIANS

Highly Effective Home Study BSEE Degree Program for Experienced Electronic Technicians. Our New Advanced Placement Program grants Credit for previous Schooling & Professional Experience. Advance Rapidly! Our 36th Year!

FREE DESCRIPTIVE LITERATURE!
Cook's Institute of Electronics Engineering
DESK 15, P.O. BOX 20345, JACKSON, MS 39209

PASS FCC EXAMS

The Original FCC Tests-Answers exam manual that prepares you at home for FCC First and Second Class Radiotelephone Licenses. Newly revised multiple choice exams cover all areas tested on the actual FCC exam. Plus - Self-Study Ability Test. Proven! \$12.95 postpaid. Moneyback Guarantee.

COMMAND PRODUCTIONS
Radio Engineering Division
P.O. Box 26348 E
San Francisco, CA 94126

PLANS & KITS

BUILD a frequency standard as accurate as WWV. Use to verify accuracy of your frequency counter. Complete circuit \$8.00. Send stamp for kit information. **DA PRODUCTS**, PO Box 566, Hampshire, IL 60140

SUBSCRIPTION TV plans: 2300 MHz microwave downconverter plus another bonus system, both for \$10.00. Parts and kits available for both systems, MC/VISA accepted on parts purchases. Negative ion generator, 3-chip telephone memory dialer (Touch-Tone, stores 32 numbers), plans \$4.00 each. Send SASE for more information. **COLLINS ELECTRONICS**, Box 6424, San Bernardino, CA 92412

NEW—Send for free information, voltmeter memory adaptor. Protects solid state circuits from costly damage. **BELL & BELL ENTERPRISES**, Box 542RE, Clearfield, UT 84015

BUILD low cost, quality parabolic TVRO satellite dish. Plans \$5.00. **HARDEN AND ASSOCIATES**, Box 187, Manteo, NC 27954

SAVE 90%. Build your own micro or minicomputer. Free details. **DIGATEK CORPORATION**, Suite E, 2723 West Butler Drive, Phoenix, AZ 85021

DECODE Morse and RTTY signals off the air with our Morse-A-Word or RTTY Reader. Morse-A-Reader keyboard also available. Quality kits or factory wired. Call or write for details. **MICRO-CRAFT**, Box 513R, Thiensville, WI 53092 (414) 241-8144

PALOMAR—pride—exclusive repair facility. Factory trained technicians—all work guaranteed. **PALOMAR/PRIDE ELECTRONICS**, 1320 Grand, San Marcos, CA 92069 (714) 744-0720

AUDIO kits. Equalizer—twelve bands/channel \$100; 24, \$225; noise reducer/expander, \$110; LED meter, \$42; see R-E cover stories 5/78, 3/81, 2/80, or send stamp for catalog. **SSS**, 912R Knobcone, Loveland, CO 80537

PROJECTION TV. . . Convert your TV to project 7 foot picture. Results equal to \$2,500 projector. Total cost less than \$20.00. Plans & lens \$16.00. Illustrated information free. Credit card orders—24 hours. (215) 736-3979. **MACROCOMGA**, Washington Crossing, PA 18977

DELAY circuit card: 5 to 100 milliseconds with 10 kHz bandwidth for ambience enhancement, special effects, and more. Needs 12 VDC. Warranty. Assembled \$84.00, kit \$64.50 ppd., or send \$1.00 for catalog & applications (included with orders). **BECCON INDUSTRIES**, Box 3726, Bellevue, WA 98009

PLANS, heretofore unpublished. Uniquely engineered for beginners. Cable television, stereo transmitter, laboratory equipment, telephone devices. Details \$2.00 (refundable). **TD BARRETT**, Box 3064, Monroe, LA 71201

NASA powerfactor controller available in kit for \$26.50. Includes circuit board, electronic parts, and plans for 120VAC motors to 1 HP. **RODCAR**, 2720 Biloxi Lane, Dept. B, Mesquite, TX 75150

PRINTED circuit boards with running water! Technological breakthrough. Precise reproduction. Ideal for beginners. Free info. **COVAL**, Dept. RE9, 2706 Kirby, Champaign, IL 61820

MICROWAVE television education manual! New publication explores concepts, antennas, downconverters: \$16.25. Information package on microwave and other exciting television products: \$2.00. **ABEX**, P.O. Box 26601-RM, San Francisco, CA 94126

CABLE TV converters and equipment, microwave antennas and downconverters. Plans and parts. Build or buy. For information send \$2.00. **C&D COMPANY**, PO Box 21, Jenison, MI 49428

ELECTRONIC catalog. Over 4,500 items. Parts & components. Everything needed by the hobbyist or technician. \$2.00 postage & handling, refundable with first \$15.00 order. (Foreign \$4.00 U.S. funds). **T&M ELECTRONICS**, 472 East Main Street, Patchogue, NY 11772 (516) 289-2520

MICROWAVE television "downconverters" under \$50.00. High quality, easily assembled. Catalog: \$2.00 (refundable). **NDS**, Box 12652-R, Dallas, 75225

Fill in below and mail to Massachusetts address.

Name _____
 Address _____ City _____
 State _____ Zip _____

TTL - STANDARD, SCHOTTKY AND LOW POWER SCHOTTKY

7400N	22	7438N	.36	74104N	.64	74159N	1.52	74197N	.72	74S05N	.48	74S153N	.96	74S280N	1.98	74LS26N	.39	74LS109N	.36	74LS170N	1.59	74LS259N	1.29	74LS375N	.64
7401N	22	7440N	.22	74107N	.48	74160N	.48	74212N	.48	74S08N	1.39	74S08N	.96	74S283N	2.95	74LS27N	.29	74LS112N	.18	74LS173N	.39	74LS266N	.36	74LS377N	1.25
7402N	24	7442N	.84	74109N	.44	74161AN	.64	74199N	.64	74S10N	.59	74S169N	.96	74S291N	5.85	74LS32N	.29	74LS123N	.59	74LS174N	.39	74LS268N	.36	74LS378N	.99
7403N	24	7445N	.84	74111N	.45	74162AN	.64	74221N	.64	74S110N	.58	74S161N	2.85	74S373N	2.95	74LS32N	.29	74LS123N	.59	74LS175N	.39	74LS273N	1.19	74LS379N	1.09
7404N	24	7446N	.84	74111N	.58	74163AN	.64	74246N	1.36	74S111N	.48	74S162N	3.70	74S374N	2.98	74LS32N	.29	74LS125N	.44	74LS181N	1.98	74LS275N	3.95	74LS390N	.98
7405N	24	7447AN	.65	74116N	1.20	74164AN	.64	74247N	1.24	74S151N	.48	74S163N	3.54	74S381N	5.95	74LS38N	.29	74LS126N	.44	74LS189N	4.45	74LS279N	.48	74LS393N	.98
7406N	36	7450N	.22	74120N	1.25	74165AN	.64	74251N	.76	74S20N	.76	74S168N	4.45	74S412N	2.98	74LS42N	.44	74LS132N	.52	74LS190N	.72	74LS280N	1.98	74LS395N	1.19
7407N	.36	7451N	.29	74121N	.48	74166AN	.68	74259N	1.89	74S30N	1.89	74S169N	4.85	74S471N	6.45	74LS47N	.68	74LS133N	.98	74LS191N	.72	74LS281N	.78	74LS447N	.37
7408N	24	7453N	.29	74122N	.52	74170N	1.98	74273N	1.99	74S32N	1.99	74S174N	6.45	74S472N	6.45	74LS48N	.99	74LS136N	.72	74LS192N	.64	74LS282N	.78	74LS490N	1.89
7409N	24	7454N	.29	74123N	.48	74172AN	.95	74276N	.98	74S37N	.89	74S175N	9.6	74S474N	6.45	74LS51N	.21	74LS138N	.48	74LS193N	.64	74LS283N	.38	74LS493N	85.00
7410N	24	7472N	.36	74125AN	.48	74173AN	.79	74278N	2.38	74S38N	.89	74S181N	3.95	74S476N	5.95	74LS54N	.21	74LS139N	.48	74LS194N	.64	74LS284N	.68	74LS569N	.84
7412N	.36	7473N	.36	74126AN	.48	74174AN	.58	74279N	.59	74S40N	.39	74S182N	1.69			74LS55N	.24	74LS145N	1.09	74LS196N	.88	74LS289N	2.50	74LS670N	1.64
7413N	.39	7474N	.36	74128N	.64	74175AN	.58	74283N	.98	74S51N	.48	74S189N	4.45	74LS00N	.17	74LS55N	.32	74LS147N	1.98	74LS197N	.88	74LS320N	2.75		
7414AN	.39	7475N	.39	74132N	.45	74176AN	.76	74293N	.72	74S74N	.58	74S194N	1.68	74LS01N	.17	74LS57AN	.32	74LS148N	1.36	74LS221N	.36	74LS321N	3.95		
7416N	.36	7476N	.39	74136N	.52	74178AN	1.09	74298N	.84	74S85N	1.98	74S195N	1.68	74LS02N	.17	74LS57AN	.32	74LS148N	1.36	74LS221N	.36	74LS321N	3.95		
7417N	.36	7478AN	.48	74141AN	.84	74179N	1.09	74351N	2.20	74S86N	.72	74S210N	5.85	74LS03N	.22	74LS58N	.38	74LS151N	3.5	74LS241N	.89	74LS323N	4.95		
7420N	.29	7484AN	1.36	74142AN	2.98	74180N	.75	74365AN	.58	74S112N	.72	74S225N	4.95	74LS04N	.22	74LS58N	.38	74LS155N	.67	74LS242N	.89	74LS324N	2.50		
7422N	.36	7485N	.66	74143AN	3.44	74182N	.52	74366AN	.69	74S114N	1.29	74S240N	2.95	74LS05N	.22	74LS58N	.38	74LS156N	.72	74LS243N	.89	74LS324N	2.50		
7423N	.36	7486N	.39	74144AN	3.44	74184AN	2.36	74367AN	.58	74S124N	2.56	74S241N	2.95	74LS08N	.17	74LS58N	.38	74LS157N	.48	74LS244N	.89	74LS325N	1.35		
7425N	.32	7490AN	.32	74147AN	1.24	74185N	2.36	74368AN	.58	74S132N	1.24	74S242AN	2.95	74LS09N	.24	74LS58N	.38	74LS158N	.48	74LS245N	1.65	74LS325N	1.65		
7427N	.32	7492AN	.38	74148AN	.89	74191AN	.68	74390N	.96	74S133N	.48	74S251N	1.19	74LS10N	.19	74LS59N	.39	74LS160N	.69	74LS246N	1.09	74LS326N	9.95		
7428N	.42	7493AN	.38	74150N	1.25	74192AN	.68	74393N	1.29	74S134N	.64	74S252N	1.95	74LS11N	.24	74LS59N	.39	74LS161N	.69	74LS247N	1.09	74LS326N	9.95		
7430N	.22	7494AN	.68	74151AN	.42	74193AN	.64	74S00N	.36	74S138N	.96	74S258N	1.09	74LS13N	.25	74LS59N	.39	74LS163N	.58	74LS248N	.96	74LS326N	9.95		
7432N	.39	7495AN	.54	74153AN	.36	74194AN	.64	74S02N	.38	74S139N	.96	74S260N	.98	74LS14N	.39	74LS59N	.39	74LS164N	.58	74LS249N	.96	74LS326N	9.95		
7433N	.39	7496N	.59	74154AN	1.29	74195AN	.48	74S03N	.38	74S140N	.74	74S274N	15.85	74LS20N	.18	74LS59N	.58	74LS165N	.89	74LS250N	.56	74LS327N	1.25		
7437AN	.36	74100N	1.38	74157N	.48	74196AN	.78	74S04N	.44	74S151N	.99	74S275N	15.85	74LS21N	.18	74LS107N	.36	74LS166N	1.64	74LS259N	.56	74LS327N	1.25		



COMPUTER SUPPORT SYSTEMS

Z80-SIO/0 2.5 MHz/22.45
Z80A-SIO/0 4.0 MHz/27.85
Z80-SIO/1 2.5 MHz/22.45
Z80A-SIO/1 4.0 MHz/27.85
Z80-CPU 2.5 MHz 6.95
Z80A-CPU 4.0 MHz 9.45
Z80-PID 2.5 MHz 7.85
Z80A-PID 4.0 MHz 10.35
Z80-CTC 2.5 MHz 5.45
Z80A-CTC 4.0 MHz 7.65
Z80-DMA 2.5 MHz 15.95
Z80A-DMA 4.0 MHz 22.95

MOS MEMORIES
 MOS Static RAM's
 Part No. Price
 2101-35 1K (256 x 4) 350NS 22 PIN 3.65
 2102-25 1K (1K x 1) 250NS 16 PIN 1.25
 P2111-45 1K (256 x 4) 450NS 18 PIN 2.85
 P2112-35 1K (256 x 4) 350NS 18 PIN 2.65
 2114L Low Power 4K (1024 x 4) 300NS 2.95
 2147 4K (4K x 1) 70NS 8.95
 2147 4K (4K x 1) 70NS 7.45

UART's
 AYS-1013A Special 3.95
 40 Khz Single 5V Supply

IK CMOS RAM
 5101 1K (256 x 4) 450NS 22 PIN Low Power 2.98

4K CMOS RAM
 P6504 4K (4K x 1) 550NS 18 PIN 110MV 5.84
 P6514 4K (1K x 4) 450NS 18 PIN 110MV 5.84

SHIFT REGISTERS
 1403A (TO-5) dual 512 bit 2.98
 1404A (TO-5) single 1024 bit 2.98
 3341APC FID bit 1 MHz 4.45
 3342PC 64 bit 3.95
 3347PC 80 bit 3.45

ECL RAM
 10410ADC/HM2106 7.95
 256 x 1 bit fully decoded 15NS 16 pin

CLOCK CHIP
 MSM5832RS 12.95
 Microprocessor Real-time Clock/Calendar

MICROPROCESSOR CHIP SETS

8035 CPU 5.95
 8039 CPU 7.95
 8080A CPU 3.95
 8085 CPU 5.60
 8155 6.45
 8212 1.65
 8214 3.45
 8216 1.65
 8224 2.95
 8225 1.65
 8228 3.95
 8251 4.40
 8253 6.65
 8255 4.40
 8257 6.95
 8259 6.95
 8279 28.00
 8755 28.00

6800 CPU 4.65
 6802 CPU 6.95
 6808 CPU 6.45
 6809 CPU 19.95
 6810 2.65
 6820 3.65
 6821 2.65
 6845 17.45
 6850 2.65
 6852 2.65

6502 CPU 7.45
 6504 CPU 7.65
 6505 CPU 7.65
 6506 CPU 5.72
 6552 7.95
 6553 10.85
 6551 10.95

EPROM'S

C1702A 2K 1US \$ 7.95
 C2708 1K x 8 450 ns \$ 3.98
 C2716E (Intel version) 16K 450NS Single 5V Supply \$ 6.98
 TMS2532 (T I Single Out) 32K (1096 x 8) 450 ns \$19.95
 C2732 (Intel version) 32K (4096 x 8) 450 ns \$18.75
 TMS2564 64K (8K x 8) 450 ns \$89.00

16K STATIC RAM (200NS) \$16.45
 TMM2016 16K (2K x 8) 300NS
 16K MOS DYNAMIC RAM (16 PIN) \$ 2.65
 4116-20 (200NS)
 4116-30 (300NS) Ceramic Special \$2.25
 4K MOS DYNAMIC RAM'S
 TMS4060-30 4K (4K x 1) 300NS 22 PIN Special \$24.00
 16K CMOS STATIC RAM
 61K MOS DYNAMIC RAM
 61K 16K (2K x 8) 150NS 16 PIN
 4164 64K (64K x 1) 200NS 16 PIN \$24.00
 4164 64K (64K x 1) 150NS 16 PIN \$29.95

CMOS

CD4001BE .18
 CD4002BE .18
 CD4006BE .29
 CD4007BE .24
 CD4008BE .39
 CD4009BE .39
 CD4010BE .39
 CD4011BE .18
 CD4012BE .18
 CD4013BE .29
 CD4014BE .67
 CD4015BE .56
 CD4016BE .32
 CD4017BE .54
 CD4018BE .52
 CD4019BE .48
 CD4020BE .67
 CD4021BE .57
 CD4022BE .79
 CD4023BE .19
 CD4024BE .44
 CD4025BE .20
 CD4026BE 1.45
 CD4027BE .42
 CD4028BE .54
 CD4029BE .69
 CD4030BE .38
 CD4033BE 1.67
 CD4034BE 2.44
 CD4035BE .69

CD4040BE .64
 CD4041BE .89
 CD4042BE .54
 CD4043BE .54
 CD4046BE .74
 CD4047BE .69
 CD4049BE .38
 CD4050BE .32
 CD4051BE .79
 CD4052BE .79
 CD4053BE .79
 CD4054BE .89
 CD4055BE .24
 CD4056BE .18
 CD4057BE .19
 CD4058BE .18
 CD4059BE .58
 CD4060BE .48
 CD4061BE .18
 CD4062BE .18
 CD4063BE .54
 CD4064BE .48
 CD4065BE .48
 CD4066BE .48
 CD4067BE .48
 CD4068BE .48
 CD4069BE .48
 CD4070BE .48
 CD4071BE .48
 CD4072BE .48
 CD4073BE .48
 CD4074BE .48
 CD4075BE .48
 CD4076BE .48
 CD4077BE .48
 CD4078BE .48
 CD4079BE .48
 CD4080BE .48

CD4108BE 1.69
 CD4510BE .58
 CD4511BE .56
 CD4512BE .72
 CD4514BE 1.68
 CD4515BE 1.54
 CD4516BE .75
 CD4519BE .52
 CD4520BE .56
 CD4522BE .78
 CD4526BE 1.25
 CD4527BE 1.59
 CD4528BE .72
 CD4531BE .84
 CD4532BE .84
 CD4539BE .59
 CD4543BE 1.44
 CD4553BE 2.89
 CD4555BE .58
 CD4556BE .58
 CD4558BE 1.89
 CD4582BE .69
 CD4584BE .42
 CD4585BE .79
 CD4702BE 8.95
 40097PC .72
 40088PC .72
 40093BE .58
 40174PC .98
 40175PC .98

OPTOELECTRONICS

L.E.D. LAMPS
 LED209 T-1 3 mm Red .09
 LED211 T-1 3 mm Green .19
 LED212 T-1 3 mm Yellow .14
 LED220 T-1 3/8 5 mm Red .11
 LED222 T-1 3/8 5 mm Green .11
 LED224 T-1 3/8 5 mm Yellow .16

DISPLAYS
 FND357 375 Common Cathode .99
 FND500 500 Common Cathode .99
 FND507 500 Common Anode .99
 DL1416 4 digit 16 segment alphanumeric display 16 mt 25.00

ISOLATORS
 ILD74 Dual Opto Isolator 1500V 1.29
 ILC74 Quad Opto Isolator 1500V 3.95
 ILC76 Dual Opto Isolator 1500V 1.29
 MCT2 Opto Coupler 1500V .54
 TIL111 Opto Coupler 1500V .54
 4N26 Opto Isolator 2500V .54
 4N33 Opto Isolator 1500V .65

PROM'S

74S288 1.88 256 bit, 16 PIN
 74S188 1.88 256 bit, 16 PIN
 93427/82S129 2.75 1K, 16 PIN
 93417/82S126 2.75 1K, 16 PIN
 93446/7621 4.95 2K, 16 PIN
 93436/7620 4.95 2K, 16 PIN
 93453/7643 6.95 4K, 16 PIN
 93448/7641 6.95 4K, 24 PIN
 93451/82S181 17.95 4K, 24 PIN
 82S185/7128 17.95 8K, 18 PIN
 74S478/7132 19.84 8K, 24 PIN
 82S191/7138 78.00 16K, 24 PIN

LINEAR IC'S

LM301AN-8 .32
 LM307N-8 .29
 LM308N-8 .88
 LM308CH .95
 LM309 .15
 LM310HC .79
 LM311CH .14
 LM311N-8 .48
 LM318N-8 .19
 LM318CH .14
 LM323K .46
 LM324N .48
 LM339N .12
 NBT26N 1.29
 NBT28N 3.65
 SN7647NF 1.98

LM741CN-8 .28
 LM747CN-14 .50
 LM748CN-8 .39
 LM1458N-8 .36
 LM1498N-14 .64
 LM1498N-14 .64
 LM1495CN-14 1.95
 LM1496CN-14 1.36
 LM2211CN-14 2.75
 LM2240PC 1.50
 LM3308 1.56
 LM3403N-14 85
 LM3524PC 2.85
 LM3900N .48
 LM4136N-14 .88
 ULN2003AN .84

SINGLE BOARD COMPUTERS

Rockwell Alm 65
 #6502 based microcomputer system with full sized keyboard, Alphanumeric 20 character display and alphanumeric 20 column thermal printer 1K Ram. Price: 445.00

Syntek sym 1
 Powerful 6502 8-bit microprocessor 6 digit HEX LED display. Single 5V power equipment. Price: 245.00

DUAL-IN-LINE LOW PROFILE I.C. SOCKETS

CONTACTS PART NO. PRICE
 8 C85-08-01 .07
 14 C85-14-01 .11
 16 C85-16-01 .13
 18 C85-18-01 .15
 20 C85-20-01 .19
 22 C85-22-01 .23
 24 C85-24-01 .23
 28 C85-28-01 .27
 40 C85-40-01 .39

DIODES & RECTIFIERS

IN4001 .04
 IN4002 .05
 IN4003 .06
 IN4004 .06

IN4726A - IN4752A (1 watt) .1

ELECTRONIC KITS FROM HAL-TRONIX

2304 MHZ DOWN CONVERTERS. TUNES IN ON CHANNELS 2 TO 7 ON YOUR OWN HOME T.V. HAS FREQUENCY RANGE FROM 2000 MHZ TO 2500 MHZ. EASY TO CONSTRUCT AND COMES COMPLETE WITH ALL PARTS INCLUDING A DIE-CAST ALUM CASE AND COAX FITTINGS, REQUIRE A VARIABLE POWER SUPPLY AND ANTENNA (Antenna can be a dish type or coffee can type depending on the signal strength in your area.)

- 2304 MOD 1 (Basic Kit) \$49.95
- 2304 MOD 2 (Basic / Pre-amp) \$59.95
- 2304 MOD 3 (Hi-Gain Pre-amp) \$69.95

POWER SUPPLY FOR EITHER MODEL ABOVE IS AVAILABLE. COMES COMPLETE WITH ALL PARTS, CASE, TRANSFORMER, ANTENNA SWITCH AND CONNECTORS (Kit) \$24.95
 Assembled.....\$34.95
 Slotted Microwave Antenna For Above Downconverters.....\$39.95

PREAMPLIFIERS

HAL PA-19—1.5 mhz to 150 mhz. 19db gain operates on 8 to 18 volts at 10ma. Complete unit \$8.95.
 HAL PA-1.4—3 mhz to 1.4 ghz. 10 to 12 db gain operates on 8 to 18 volts at 10ma. Complete unit \$12.95.
 (The above units are ideal for receivers, counters, etc.)

- 16 LINE TOUCH TONE DECODER KIT WITH P.C. BOARD AND PARTS\$69.95
- 12 LINE TOUCH TONE DECODER KIT WITH P.C. BOARD AND PARTS\$39.95
- 16 LINE ENCODER KIT, COMPLETE WITH CASE, PAD AND COMPONENTS\$39.95
- 12 LINE ENCODER KIT, COMPLETE WITH CASE, PAD AND COMPONENTS\$29.95

MANY, MANY OTHER KITS AVAILABLE

Send 15¢ stamp or S.A.S.E. for information and flyer on other HAL-TRONIX products. To order by phone: 1-310-265-1762.



HAL-TRONIX
 P.O. Box 1101
 Southgate, MI 48195

SHIPPING INFORMATION: ORDERS OVER \$20.00 WILL BE SHIPPED POSTPAID EXCEPT ON ITEMS WHERE ADDITIONAL CHARGES ARE REQUESTED. ON ORDERS LESS THAN \$20.00 PLEASE INCLUDE ADDITIONAL \$1.50 FOR HANDLING AND MAILING CHARGES.

CIRCLE 64 ON FREE INFORMATION CARD

FREE KIT Catalog
 FUNCTION GENERATOR KIT \$59.95 contains TEST & EQUIP
 Auto-Ranging Cap-meter kit \$79.95 EXPERT-MENTERS EQUIP
Phone 415-447-3433
 Write or Phone for FREE CATALOG. Average 1 minute Saturday call is 21¢.
DAGE SCIENTIFIC INSTRUMENTS
 BOX 1054R LIVERMORE CA 94550

MUSICAL HORN

continued from page 58

switch should be a normally-open type. If you use a speaker rated at less than 10 watts, see Table 1 for the series resistor to use. If you're not sure of the speaker rating, use a 39-ohm, 2-watt resistor to be safe. Bear in mind that driving a 10-watt horn speaker with no resistor provides the loudest, most directional, sound.

Be particularly careful about the power connections. Use fairly heavy leads, and make sure that the positive side of the power source is connected to the positive-input lead. The power source should be 12 volts, capable of providing over 1 ampere of current. That means a 12-volt car battery or heavy-duty power supply!

Troubleshooting

If you don't get a melody, disconnect the board from the power source and remove the song PROM, IC9. Now re-

apply power, press S1, and you should hear a steady tone. If not, check your connections and the polarities of the diodes and capacitors, make sure the correct components are in the correct locations, and make sure that Q1 is inserted correctly. Next verify the orientation of all IC's—and check for bent-under pins. Defective IC's are rare, but they may be checked most easily by substitution, if no other problems are found.

Packaging

This unit is intended to be used in a vehicle, drawing power from the vehicle battery. No power is drawn except when switch S1 is held down. The unit should be installed in a plastic case under your dashboard (not in the engine compartment) with the potentiometers, speaker jack and switch on the cover, and a power supply jack on the side, for example. Use a 3-amp fuse in the power leads, and use heavy wire for the leads and speaker connections. Mount the speaker somewhere behind the vehicle's grille. **R-E**

PRINTED circuit boards from sketch or artwork. Kit projects. Free details. **DANOCINTHS INC.**, Box 261, Westland, MI 48185

FREE catalog IC's semis, parts. **CORONET ELECTRONICS**, 6494 Notre Dame W., Montreal, Que, Canada H3C 1H8 US inquiries

VIDEO

VIDEO movies: Bought/sold/exchanged. Wholesale video accessories, electronic parts/supplies. Catalog \$1.00. **ASTRO ELECTRONICS**, Old Grand Union Shopping Center, Stony Point, NY 10980

WANTED

ADDRESSERS—mailers—homeworkers needed! 50 firms listed, rush 50 cents, addressed envelope. **BONNIE NIEUWENDAAL**, P.O. Box 23432, Tampa, FL 33623

TRS-80® DISCOUNT



BUY DIRECT

1-800-841-0860 TOLL FREE

MICRO MANAGEMENT SYSTEMS INC.
 DEPT. NO. 15

Downtown Plaza Shopping Center
 115C Second Ave. S.W.
 Cairo, Georgia 31728
 912-377-7120 Go. Phone No.

Write For Free Catalog

COMPUTER MARKET CENTER

COMPUTER MARKET CENTER ADVERTISING RATES 1" by 1 column (1 5/8") \$55.00. 1 1/2" by 1 column (1 5/8") \$82.50. 2" by 1 column (1 5/8") \$110.00. All ads must be prepaid. Send order and remittances to Computer Market Center, **Radio-Electronics Magazine**, 200 Park Avenue South, New York, New York, 10003. Address telephone inquiries to 212-777-6400. Frequency rates are available.

TEXAS

PDP8 Options

- CR8-E (CTL) \$720
- DK8-E \$400
- DK8-EC \$400
- DK8-EP \$505
- DKC8-AA \$580
- H948-BA \$550
- H960-AA \$950
- H967-AB \$1,050
- H9603-CA \$2,160
- KA8-E \$450
- KC8-AA \$652

Federated Consultants
 1218 South Ervay
 Dallas, TX. 75215
 214-428-5300 (Brier)
 Master Charge & Visa Accepted

CALIFORNIA

FREE! INFO-PAK for small computer users mailed twice a year. We sell and broker all kinds of **SMALL COMPUTER SOFTWARE** from S-100 to TRS-80. **SOFTWARE REVIEW**, 704 Solano Ave., Albany, CA 94706 (415) 527-7730.

BUY THIS SPACE

\$55.00 puts your ad in this space in front of 197,223 active Radio-Electronics readers. To place your ad write Computer Market Center, Radio-Electronics, 200 Park Avenue South, New York, New York 10003 or call 212-777-6400.

CANADA

DYNAMIC INFORMATION TECHNOLOGIES LTD.
 P.O. BOX 6553 STN.A.
 SAINT JOHN, N.B., CANADA
 E2L 4R9 (506) 642-4260
TERMINALS, PRINTERS, MICROCOMPUTERS SOFTWARE.

SUPPORT MARCH OF DIMES

RETAILERS

An ad for your computer store in this space in Radio-Electronics **COMPUTER MARKET CENTER** puts you in touch with our computer audience. They use microcomputer equipment for both business and hobby interests. For further details call 212-777-6400.

Take stock in America. Buy U.S. Savings Bonds.

HINTS & TIPS

continued from page 71

guns have a small delicate tip suitable for working around IC's and other tiny components. What you really need is a soldering iron with two temperature settings: one for regular use; the other an "idle" setting that keeps the iron warm but won't allow it to overheat. No doubt there are a number of those on the market, but half the fun of doing it yourself is not to spend all that money.

The circuit shown in Fig. 4 changes any AC soldering iron into a two-setting, switch-selectable soldering "tool." All of the parts are available from your local electronics dealer, or you just may have them already in your junk-box. There's nothing really critical about the circuit or the components: a cord assembly to bring 117 volts AC in, a diode that rectifies the 117 volts. AC

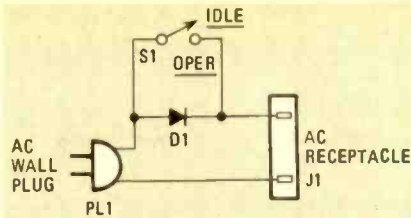

FIG. 4—ADD A STANDBY or WARM setting to almost any AC soldering iron with this circuit.

PARTS LIST—IRON IDLER

- D1—1N5404, 400 PIV, 3 amps (Radio Shack 276-1144 or equivalent)
 S1—SPST switch (Radio Shack 275-612 or equivalent)
 PL1—AC plug
 J1—AC chassis-mount socket (Radio Shack 270-642 or equivalent)
Miscellaneous: Small case, line cord, hardware, etc.

into pulsating DC at a lower effective voltage, a chassis mount AC receptacle

to plug the soldering iron into, and a switch. With S1 open as shown in the schematic, pulsating DC is sent to the soldering iron, keeping it warm but not allowing it to reach full operating temperature.

When S1 is closed, the diode is bypassed and full-line voltage reaches the soldering iron, which heats up to full temperature and is ready to use in a matter of seconds. You might want to get fancy and use a leaf-switch for S1. When the iron is lying across it, the diode is in circuit, and when the iron is lifted, the diode is bypassed. No matter how simple or fancy you make that circuit, you will find it helpful in your work or hobby.

Hints, kinks, and tips are all great and useful, but in closing, I'll share a secret with you—one which has been of immeasurable assistance to me for years: **KISS (Keep It Simple, Stupid)!** Don't try to reinvent the wheel; the best ideas are the simple ones. **R-E**

BUSINESS OPPORTUNITIES

MECHANICALLY inclined individuals desiring ownership of Small Electronics Manufacturing Business—without investment. Write: **BUSINESS-ES**, 92-R, Brighton 11th, Brooklyn, NY 11235

SUCCESSFUL TV stereo specialties sales/service store. \$200,000.00./year income, will consider trade. (209) 442-1816. 3134 Palm, Fresno, CA 93704

HIGHLY PROFITABLE

ONE-MAN ELECTRONIC FACTORY

Investment unnecessary. knowledge not required. sales handled by professionals. Ideal home business. Write today for facts! **Postcard will do. Barta-RE-Q, Box 248, Walnut Creek, CA 94597.**

\$700 per month earnings possible filling out income tax forms at home or tax office during tax season. We show you how. Simple, quickly learned. Details mailed free. No salesmen. Hurry. Big demand. **FEDERATED TAX**, 2015 Montrose, Chicago, IL 60618

PROJECTION TV . . . Make \$200.00+ per evening assembling projectors . . . Easy . . . Results equal to \$2,500 projectors . . . Your total

cost less than \$15.00 . . . Plans, lens & dealer's information \$14.00 . . . Illustrated information free . . . **MACROCOMGAX**, Washington Crossing, PA 18977. Credit card orders 24 hours. (215) 736-2880.

NATIONWIDE listings of major companies actively employing engineers and technicians. Free details. **AVI**, Box 264R, Buffalo, NY 14215

LCD pen watch US\$10.00/pc. airfreighted, discounts given dealers, reply: **RELIANT (ENGINEERING) CO.**, P.O. Box 33610, Sheungwan, Hong Kong.

ATV Research ...specialists in **CCTV** and computer monitors!

Video monitors - color & B/W * TV Cameras, kits, parts & plans * Video-to-RF modulators * Free catalog. Phone or write. (402) 987-3771

13-RE Broadway Dakota City, NE. 68731

CB RADIO

GET more CB channels and rangel Frequency expanders, boosters, speech processors, interference filters, VOX, how-to books, plans. Catalog \$2. **CB CITY**, Box 31500RE, Phoenix, AZ 85046

HOBBY ROBOTICS' Shoppers Mart

— For the SERIOUS Hobbyist —

MANUAL RU-2

Hobby Robotics Directory

Amateur Robotics Designers Newsletter

ARD Newsletter. Quarterly. Keeps you abreast of latest news, perks up interest! \$6.00

Complete RU-2 Manual! Everything you need to build your own robot shown, detailed! Build from base up with Hobby Robotics' highly maneuverable 2-ft. per sec. super-traction base, extendable arms illustrated at 15 lbs., grip-like hands! Manual only \$25.00, refundable with first purchase.

Hobby Robotics' Parts Supplier Directory. Check-full of names, addresses, phone numbers you want for hard-to-find parts systems, build-your-own-robot info. Only \$3.50. Get yours now!

HOBBY ROBOTICS
 5070 Buford Highway
 Norcross, Ga. 30071 404/448 0190

Please send items checked below:

Or Newsletter RU-2 Manual

Parts Directory Robot Base

FREE Hobby Robotics' Catalog **FREE**

Total Enclosed \$ _____ (includes shipping)

Personal Check Cashiers Check/M.O.

MasterCard Bank Americard

Acc# _____
 Signature _____ Exp. _____
 Name _____
 Address _____
 City _____
 State _____ Zip _____

HOBBY ROBOTICS' ROBOT BASE
 Ready to roll!
ONLY \$495 (includes shipping)

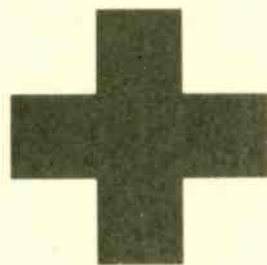

American Red Cross

Together, we can change things.

A Public Service of This Magazine & The Advertising Council



National Semiconductor Clock Modules

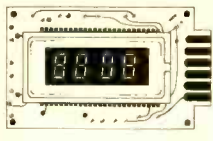

12VDC AUTOMOTIVE/ INSTRUMENT CLOCK
APPLICATIONS:
 • In-dash autoclcks
 • After-market auto/ RV clocks
 • Aircraft-marine clcks.
 • 12VDC oper. instrum.
 • Portable/battery powered instrumts.

Features: Bright 0.3" green display. Internal crystal time-base. ± 0.5 sec./day accur. Auto. display brightness control logic. Display color filterable to blue, blue-green, green & yellow. Complete - just add switches and lens.

MA1003 Clock Module (3.05" L x 1.75" H x 0.38" D) . \$16.95

CLOCK MODULES

MA1023 .7" Red Digital LED Clock Module	8.95
MA1026 .7" Dig. LED Alarm Clock/Thermometer	18.95
MA5036 .3" Red Digital LED Clock/Timer	6.95
MA1002 .5" Red Digital LED Clock & Xformer	9.95
MA1010 .8" Red Digital LED Clock	7.95
MA1032 CBA .5" Red Digital LCD Clock	17.95
MA1043 .7" Green Digital LED Clock	8.95

TRANSFORMERS

102-P20 Xformer for MA1023, 1043 & 5036 Mods.	3.49
102-P22 Xformer for MA1026 Clock Modules	3.49
102-P24 Xformer for MA1010 Clock Modules	3.49



8 OHM SPEAKER
 2 1/4" - 8 Ohm - .25 watt
 A0201
 \$1.25 ea. 2/\$1.95 ea. 10/\$7.95 ea.



BATTERY HOLDER
 • Holds 2 ea. C cells
 • Aluminum Case
 • 5" leads
 H-801-159
 \$.45 each 10/\$3.95



BATTERY HOLDER
 • Holds 4 ea. C cells
 • Plastic case
 • 9" leads
 82721
 \$.49 ea. 10/\$4.25



EPROM Erasing Lamp

- Erases 2708, 2716, 1702A, 5203Q, 5204Q, etc.
- Erases up to 4 chips within 20 minutes.
- Maintains constant exposure distance of one inch.
- Special conductive foam liner eliminates static build-up.
- Built-in safety lock to prevent UV exposure.
- Compact - only 7.5/8" x 2.7/8" x 2"
- Complete with holding tray for 4 chips.

UVS-11E Replacement Bulb \$16.95
UVS-11E \$79.95



JOYSTICKS

JS-5K	5K Linear Taper Pots	\$5.25
JS-100K	100K Linear Taper Pots	\$4.95
JVC 40	40K (2) Video Controller in case	\$4.95



6-Digit Clock Kit

- Bright .300 ht. comm. cathode display
- Uses MMS5314 clock chip
- Switches for hours, minutes and hold modes
- Hrs. easily viewable to 20 ft.
- Simulated walnut case
- 115 V AC operation
- 12 or 24 hr. operation
- Incl. all components, case & wall transformer
- Size: 6 1/2" x 3 1/8" x 1 1/4"

JE 701 \$19.95

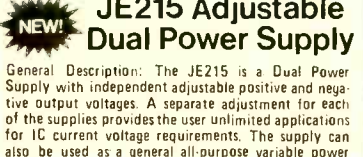

JE215 Adjustable Dual Power Supply

General Description: The JE215 is a Dual Power Supply with independent adjustable positive and negative output voltages. A separate adjustment for each of the supplies provides the user unlimited applications for IC current voltage requirements. The supply can also be used as a general all-purpose variable power supply.

FEATURES:

- Adjustable regulated power supplies, pos. and neg. 1.2VDC to 15VDC
- Power Output (each supply) 5VDC @ 500mA, 10VDC @ 750mA, 12VDC @ 500mA, & 15VDC @ 175mA
- Two, 3-terminal adj. IC regulators with thermal overload protection.
- Heat sink regulator cooling
- LED "on" indicator
- Printed Board Construction
- 120VAC Input
- Size: 3 1/2" x 5 1/16" L x 2 1/8" H

JE215 Adj. Dual Power Supply Kit (as shown) . \$24.95
 (Picture not shown but similar in construction to above)
 JE200 Reg. Power Supply Kit (5VDC, 1 amp) . \$14.95
 JE205 Adapter Brd. (to JE200) ±5, ±9 & ±12V. \$12.95
 JE210 Var. Pwr. Sply. Kit, 5-15VDC to 1.5amp. \$19.95

MICROPROCESSOR COMPONENTS

8080A/8080A SUPPORT DEVICES

INS8080A CPU	4.95
DP2127 8-Bit Input/Output	3.75
DP2124 Priority Interrupt Controller	3.75
DP2126 Bi-Directional Bus Driver	3.75
DP2124 Clock Generator/Driver	3.49
DP2127 Bus Driver	3.49
DP2126 System Controller/Bus Driver	4.95
DP2128 System Controller	5.95
INS243 I/O Expander for 48 Series	7.95
INS242 Asynchronous Counter, 11-bit	16.95
DP2125 I/O Expander for 48 Series	9.95
DP2125 Prog. Comm. I/O (USART)	14.95
DP2125 Prog. Interval Timer	14.95
DP2125 Prog. Parity/Parity (PPP)	9.95
DP2125 Prog. DMA Controller	15.95
DP2125 Prog. Interrupt Control	14.95
DP2125 Prog. CRT Controller	39.95
DP2125 Prog. Keyboard/Display Interface	15.95
DP2125 System Timing Element	6.95
DP2125 8-Bit Bi-Directional Receiver	3.95
DP2125 8-Bit Bi-Directional Receiver	3.95
DP2125 8-Bit Bi-Directional Receiver	3.95
DP2125 Octal Latched Peripheral Driver	5.25
DP2125 Octal Latched Peripheral Driver	5.25

DATA ACQUISITION (CONTINUED)

AIC087CCN 8-Bit A/O Converter (8-Ch. Multi.)	5.75
AIC087CCN 8-Bit A/O Converter (16-Ch. Multi.)	10.95
DAC1008CCN 8-Bit D/A Converter (8-Ch. Comp.) (0.001%)	8.95
DAC1008CCN 10-Bit D/A Conv. Micro. Comp. (0.20%)	8.95
DAC1008CCN 10-Bit D/A Converter (0.00% Lin.)	8.49
DAC1027CCN 10-Bit D/A Converter (0.20% Lin.)	5.95
DAC1227CCN 12-Bit D/A Converter (0.20% Lin.)	9.95
CD4049N 3-Channel Multivibrator	1.15
AV-51013 30K BAUD UART	6.95

6800/6800 SUPPORT DEVICES

MC6800 MPU	7.95
MC6800CPU 1Mx8 Static RAM	14.95
MC6801 Peripheral Interf. Adapt (MC6800)	7.49
MC6802 Priority Interrupt Controller	10.95
MC6803 1024-Bit ROM (VCMCA8-B)	14.95
MC6804 Asynchronous Comm. Adapter	8.25
MC6805 Synchronous Serial Data Adapter	6.95
MC6806 4000bps Modem	12.95
MC6807 7400bps Modulator	12.95
MC6808A Quad 3-State Bus, Trans. (MC6876)	2.25

PROMS/EPROMS

1702A 2K V EPROM	6.75
2708 8K EPROM	4.95
2716 16K EPROM (5V, +5V, +12V)	10.95
2716Intel(2716)T 16K EPROM (Single +5V)	8.95
2721Intel T1 32K EPROM	17.95
2764 64K EPROM (50ns) (Single +5V)	7.49
2764 64K EPROM	9.95
2708 2048 EPROM (Open Collector)	1.95
825115 4096 Bipolar PROM	15.95
825116 32-Bit Tri-State Bipolar PROM	3.95
825118 8K EPROM	19.95

MICROPROCESSOR CHIPS

Z80 (Z80C) CPU	12.95
Z80A (Z80) CPU (MK480N-4) (4M12)	15.95
CDP1802 CPU	18.95
7850 CPU (80V) CPU	15.95
80C86 CPU 8-Bit Slice (Com. Temp. Grade)	15.95
MC5602 MPU w/Clock (65K Bytes Memory)	11.95
INS5051N4 MPU 16-Bit (8M12)	9.95
INS5051N4 CPU 16-Bit (8M12) (8M12)	14.95
INS5040N4 CPU (256 Bytes RAM)	24.95
INS5070N CPU 64 Bytes RAM	24.95
INS5073N CPU w/Basic Microp Interpreter	29.95
PI8025 MPU-16-Bit	49.95

ROM'S

25132(140) Character Generator (Upper Case)	9.95
25132(201) Character Generator (Lower Case)	9.95
25132(201) 32-Bit PROM (Open Collector)	11.95
MC68709 128x72 ASCII Shifted w/Checksum	13.50
MC68709 128x72 Math Symbol & Pictures	13.50
MC68709 128x72 Alpha, Control Chas. Gen.	13.50

SHIFT REGISTERS

MM5001 Dual 26-Bit Dynamic	50
MM5004 Dual 26-Bit Dynamic	50
MM5006 Dual 100-Bit Dynamic	50
MM5010 Dual 64-Bit Accumulator	50
MM5012N 256-Bit Dynamic	2.95
MM5013N 1024-Bit Dynamic/Accumulator	1.95
MM5016N 500/512-Bit Dynamic	1.95
MM5024N Octal 8-Bit	9.95
MM5025N Octal 8-Bit	9.95
2501V (10A) 1024-Bit Dynamic	1.95
2511N Hex 32-Bit Static	3.95
2521V Dual 128-Bit Dynamic	2.95
2524V 512-Bit Dynamic	.99
2525V 1024-Bit Dynamic	2.95
2527V Dual 256-Bit Static	3.95
2529V Dual 240-Bit Static	3.95
2532N Quad 80-Bit Static	6.95
3131HC F16 (Dual 8)	2.95

MICROPROCESSOR MANUALS

AV-5100 User Manual	11.50
MC68010 User Manual	7.50
MC68012 User Manual	7.50
MC68013 User Manual	7.50

DATA ACQUISITION

AF100-1CN Universal Active Filter 2.5%	5.95
AF121-1CJ Touch Tone Low Band Filter	19.95
AF121-1CJ Touch Tone High Band Filter	19.95
LM338N Super Gain Op Amp	1.15
LM338Z Constant Current Source	1.40
LM335Z Temperature Transducer	1.30
JFET1 Input Op Amp	1.35
LF398N 58mV & Hold Amplifiers	3.95
LM399N Temp. Comp. Prec. Ref. (1.00mV/C)	4.95
ADC0808CCN 8-Bit A/D Converter (1.5%)	4.95
DAC0808CCN 8-Bit D/A Converter (0.75% Lin.)	2.25

SPECIAL FUNCTION

DS005CN Dual MOS Clock Driver (5M2)	1.50
DS005CN Dual MOS Clock Driver (5M2)	1.50
INS171N-1 Floppy Disc Controller	24.95
INS268N Communication Chip	19.95
MM5816N Microprocessor Real Time Clock	8.95
MM5817N Microprocessor Compatible Clock	11.95
MM5818N Microcontroller with 64-Digit RAM and Direct LED Drive	6.95
CD4042M Microcontroller with 64-Digit RAM & Direct LED Drive w/Bus Int.	7.49
CD4042N Microcontroller with 64-Digit RAM & Direct LED Drive	7.49

TELEPHONE/KEYBOARD CHIPS

AV-5100 Push Button Telephone Dialer	14.95
AV-5100 Repertory Dialer	14.95
AV-5100 CMOS Clock Generator	4.95
AV-5137S Keyboard Encoder (84 keys)	11.95
HD016S-5 Keyboard Encoder (16 keys)	5.49
HC7232 Keyboard Encoder (20 keys)	5.75
MM5190N Push Button Pulse Dialer	8.95
MM5199N 96/144-Key Serial Keyboard Encoder	7.95

ELECTRONIC TOY MOTORS

Typical Power Source	Operating Voltage Range	Volts	TYPICAL CHARACTERISTICS											
			NO LOAD					AT MAXIMUM EFFICIENCY					SMALL TORQUE	
DRY CELL	1.5 to 6.0	3.0	Speed RPM	Current AMP	Speed Current	Eff. %	Dist. In.	Dist. In.	W	W	W	W	W	W
DRY CELL	1.5 to 6.0	3.0	9,200	0.20	6,750	0.90	0.26	1.30	57.0	0.97				

937 O.D. X 1.201 Length
MABUCHI RE280 \$.99 each . . . 10/\$7.50 . . . 100/\$50.00

GLOBAL SPECIALTIES

EXPERIMENTOR SOCKETS

Model	Length	Width	Center Channel	5 Tie Point Terminals	Bus Strips	Price
EXP48	6.0"	1.0"	n/a	n/a	41(160)	\$ 4.75
EXP300	6.0"	2.1"	3"	94(1470)	2(80)	\$12.00
EXP325	1.8"	2.1"	3"	22(110)	2(80)	\$ 3.50
EXP350	3.5"	2.1"	3"	48(230)	2(80)	\$ 6.75
EXP600	6.0"	2.4"	6"	94(1470)	2(80)	\$14.75
EXP650	3.5"	2.4"	6"	48(230)	2(80)	\$ 8.75

\$10.00 Min. Order - U.S. Funds Only
 Calif. Residents Add 6% Sales Tax
 Postage - Add 5% plus \$1 Insurance

Spec Sheets - 25¢
 Send 86¢ Postage for your
FREE 1982 JAMECO CATALOG

Jameco ELECTRONICS
 MAIL ORDER ELECTRONICS - WORLDWIDE
 1355 SHOREWAY ROAD, BELMONT, CA 94002
 PRICES SUBJECT TO CHANGE

PHONE ORDERS WELCOME (415) 592-8097

POWER CORD SALE

1-9 842-812	10.99	100
35	.30	25
1-9 362-812	10.99	100
39	.35	30
1-9 10-99	10.99	100
45	.39	35
1-9 468-828	10.99	100
49	.45	39
1-9 435-802	10.99	100
59	.55	49

AC and DC Wall Transformers

Part No.	Input	Output	Price
AC 500	117V/60Hz	12 VAC 250mA	\$3.95
AC 500	117V/60Hz	12 VAC 500mA	\$4.95
AC1000	117V/60Hz	12 VAC 1 amp	\$5.95
AC1700	117V/60Hz	9 VAC 1.7 amp	\$3.95
DV 9200	117V/60Hz	9 VDC 200mA	\$3.25
DC 900	120V/60Hz	9 VDC 500mA	\$3.95

CONNECTORS

DB25P	D-Subminiature Plug	\$2.95
DB25S	D-Subminiature Socket	\$3.50
D20418-2	Screw Lock Hdwr. (2) DB25S/P	\$.49
DB51226	Cover for DB25P/S	\$1.75
22/44E	P.C. Edge (22/44 Pin)	\$2.95
UG88/U	BNC Plug	\$1.79
UG89/U	BNC Jack	\$3.49
UG175/U	UHF Adapter	\$1.79
5059	UHF Panel Recp.	\$1.29
PL258	UHF Adapter	\$1.60
PL259	UHF Plug	\$1.60
UG260/U	BNC Plug	\$1.79
UG1094/U	BNC Bulkhead Recp.	\$1.29

TRS-80 16K Conversion Kit

Expand your 4K TRS-80 System to 16K.
 Kit comes complete with:
 * 8 ea. MM5290 (UPD416/4116) 16K Dyn. Rams (*NS)
 * Documentation for Conversion

TRS-16K2 *150NS \$29.95
TRS-16K4 *250NS \$24.95

JE610 ASCII Encoded Keyboard Kit

The JE610 ASCII Keyboard Kit can be interfaced into most any computer system. The kit comes complete with an industrial grade keyboard switch assembly (62-keys), IC's, sockets, connector, electronic components and a double-sided printed wiring board. The keyboard assembly requires +5V @ 150mA and -12V @ 10 mA for operation. Features: 60 keys generate the 126 characters, upper and lower case ASCII set. Fully buffered. Two user-definable keys provided for custom applications. Caps lock for upper-case only alpha characters. Utilizes a 2376 (40 pin) encoder read-only memory chip. Outputs directly compatible with TTL/DTL or MOS logic arrays. Easy interfacing with a 16-pin dip or 18-pin edge connector. Size: 3 1/4" H x 14 1/2" W x 8 3/4" D

JE610/DTE-AK (After assembled as pictured above) \$124.95

JE610 Kit 62-Key Keyboard, PC Board, & Components (no case) . . . \$ 79.95
K62 62-Key Keyboard (Keyboard only) . . . \$ 34.95
DTE-AK (case only - 3 1/4" H x 14 1/2" W x 8 3/4" D) \$ 49.95

JE212 - Negative 12VDC Adapter Board Kit for JE610 ASCII KEYBOARD KIT Provides -12VDC from incoming 5VDC . . . \$9.95

JE600 Hexadecimal Encoder Kit

FULL 8-BIT LATCHED OUTPUT 19-KEY KEYBOARD

The JE600 Encoder Keyboard Kit provides two separate hexadecimal digits produced from sequential key entries to allow direct programming for 8-bit microprocessor or 8-bit memory circuits. Three additional keys are provided for user operations with one having a bistable output available. The outputs are latched and monitored with 9 LED readouts. Also included is key entry strobe. Features: Full 8-bit latched output for microprocessor use. Three user-definable keys with one being bistable operation. Debounce circuit provided for all 19 keys. 9 LED readouts to verify entries. Easy interfacing with standard 16-pin IC connector. Only +5VDC required for operation. Size: 3 1/4" H x 8 3/4" W x 8 3/4" D

JE600/DTE-HK (After assembled as pictured above) . . . \$99.95

JE600 Kit 19-Key Hexadec. Keyboard, PC Board & Cmpnts. (no case) . . . \$59.95
K19 19-Key Keyboard (Keyboard only) . . . \$14.95
DTE-HK (case only - 3 1/4" H x 8 3/4" W x 8 3/4" D) \$44.95

7400			
SN7400N	25	SN74122N	35
SN7401N	20	SN74123N	29
SN7402N	25	SN74124N	35
SN7403N	25	SN74125N	49
SN7404N	25	SN74126N	35
SN7405N	29	SN74127N	5.00
SN7406N	25	SN74128N	50
SN7407N	25	SN74129N	69
SN7408N	29	SN74130N	99
SN7409N	29	SN74131N	89
SN7410N	25	SN74132N	35
SN7411N	29	SN74133N	1.25
SN7412N	35	SN74134N	2.79
SN7413N	40	SN74135N	3.95
SN7414N	69	SN74136N	4.95
SN7415N	29	SN74137N	1.39
SN7417N	29	SN74138N	1.99
SN7420N	25	SN74139N	89
SN7421N	29	SN74140N	59
SN7422N	45	SN74141N	89
SN7423N	29	SN74142N	1.25
SN7425N	29	SN74143N	1.99
SN7426N	29	SN74144N	1.99
SN7427N	29	SN74145N	79
SN7428N	25	SN74146N	3.95
SN7429N	25	SN74147N	3.95
SN7430N	25	SN74148N	69
SN7431N	25	SN74149N	69
SN7432N	25	SN74150N	69
SN7433N	25	SN74151N	69
SN7434N	25	SN74152N	69
SN7435N	25	SN74153N	69
SN7436N	25	SN74154N	69
SN7437N	25	SN74155N	69
SN7438N	25	SN74156N	69
SN7439N	25	SN74157N	69
SN7440N	25	SN74158N	69
SN7441N	69	SN74159N	69
SN7442N	59	SN74160N	69
SN7443N	1.10	SN74161N	69
SN7444N	1.10	SN74162N	69
SN7445N	89	SN74163N	69
SN7446N	79	SN74164N	69
SN7447N	69	SN74165N	69
SN7448N	79	SN74166N	69
SN7449N	29	SN74167N	69
SN7450N	20	SN74168N	69
SN7451N	20	SN74169N	69
SN7452N	20	SN74170N	69
SN7453N	20	SN74171N	69
SN7454N	20	SN74172N	69
SN7455N	25	SN74173N	69
SN7456N	20	SN74174N	69
SN7457N	20	SN74175N	69
SN7458N	20	SN74176N	69
SN7459N	20	SN74177N	69
SN7460N	20	SN74178N	69
SN7470N	29	SN74179N	69

4-Digit 16 Segment Alphanumeric Intelligent Display with Memory, Recorder, Driver

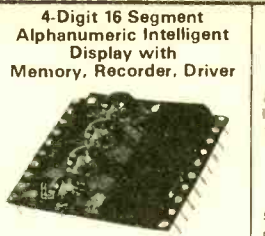

End stackable. 4-character package. High contrast 180µm high magnified monolithic characters. 64 Character ASCII format. Built-in memory, decoder, multiplexer and drivers. Direct access 16 digit independently addressable chronously. Five volt logic. TTL compatible. Five volt power supply only. Independent cursor function. Size: 1" x 1.3" x 1.6" x 225 D.

DL-1416 Alphanumeric Display \$19.95 ea.

10-Segment Bargraph Displays (with On-Board Driver IC Chip)

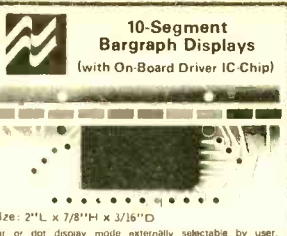

Size: 2" L x 7/8" H x 3/16" D.
On or dot display mode externally selectable by user. Packages are stackable to expanded displays. Can be cascaded to 10 arrays. 100 bargraph elements. LED current programmable from 2mA to 30mA. Stable internal voltage reference for full scale analog inputs from 1.2 to 12V. Each LED output driver IC with external access. Size: 2" x 7/8" x 3/16".

NSM3914 Linear Function (16 bars green/4 red) 6.95
NSM3915 Logarithmic Function (10 bars red) 5.95
NSM3916 Arithmetic Function (16 pin, 2 volt, 2 rd) 6.95
NSM3916 VU-Meter Function (10 bars red) 5.95
NSM3918 VU-Meter Function (16 pin, 2 volt, 2 rd, 1) 6.95

Part No.	Function	Price	
70451PI	CMOS Precision Timer	14.95	
70451K/Kit*	Stopwatch Chip, XTL	24.95	
7106CPL	3 1/2 Digit A/D (LCD Drive)	16.95	
7106V/Kit*	IC, Circuit Board, Display	34.95	
7107CPL	3 1/2 Digit A/D (LED Drive)	15.95	
7107V/Kit*	IC, Circuit Board, Display	29.95	
7116CPL	3 1/2 Digit A/D LCD DS. H.L.D.	18.95	
7117CPL	3 1/2 Digit A/D LED DS. H.L.D.	17.95	
7201IDR	Low Battery Volt Indicator	2.25	
7205V/Kit*	CMOS LED Stopwatch/Timer	12.95	
7205V/Kit*	Stopwatch Chip, XTL	19.95	
7206CJPE	Tone Generator	5.15	
7206CEVD	Tone Generator Chip, XTL	12.95	
7207AIPD	Oscillator Controller	19.95	
7207AIPD/Kit*	Freq. Counter Chp, XTL	13.95	
72081PI	Seven Decade Counter	17.95	
72091PA	Clock Generator	3.95	
72151PG	4 Func. CMOS Stopwatch CKT	13.95	
7215V/Kit*	4 Func. Stopwatch Chp, XTL	19.95	
7216AJJ	8-Digit Univ. Counter C.A.	32.00	
7216CJ	8-Digit Freq. Counter C.A.	26.95	
7216D1PI	8-Digit Freq. Counter C.A.	21.95	
72171J	4-Digit LED Up/Down Counter	12.95	
72181J	Freq. Counter Chp, XTL	17.95	
72191J	LCD 4 1/2 Digit Up Counter DR1	11.25	
7226AJJ	8-Digit Univ. Counter	31.95	
7226V/Kit*	5 Function Counter Chp, XTL	74.95	
72341JE	CMOS Bin Prog. Timer/Counter	4.95	
72351PA	CMOS BCD Prog. Timer/Counter	2.05	
72501JE	CMOS BCD Prog. Timer/Counter	6.00	
72551PA	CMOS BCD Prog. Timer/Counter	2.25	
72551PE	CMOS 555 Timer (8 pin)	1.45	
72551PE	CMOS 555 Timer (14 pin)	2.25	
7611BCPA	CMOS Op Amp Comparator	5MV 2.25	
7612BCPA	CMOS Op Amp Ext. Cmvr.	5MV 2.25	
7613BCPA	CMOS Dual Op Amp Comp.	5MV 3.95	
76131CPE	CMOS Tri Op Amp Comp.	10MV 5.35	
76131CPE	CMOS Quad Op Amp Comp.	10MV 7.50	
7642CCPD	CMOS Quad Op Amp Comp.	10MV 7.50	
7660CCPA	Voltage Converter	2.95	
8036CCPD	Waveform Generator	LM709N 21.50	
8036CCPD	Monolithic Quadratic Ref. Diode	500µm Band - GAP Volt Ref. Diode	2.50
8212CPA	Volt Ref/Indicator	8212CPA	2.95
8212CPA	Volt Ref/Indicator	8212CPA	2.95

74LS			
74LS00	29	74LS192	1.15
74LS01	29	74LS193	1.15
74LS02	29	74LS194	1.15
74LS03	29	74LS195	1.15
74LS04	29	74LS196	1.15
74LS05	35	74LS197	1.15
74LS06	35	74LS198	1.15
74LS07	35	74LS199	1.15
74LS08	35	74LS200	1.15
74LS09	35	74LS201	1.15
74LS10	35	74LS202	1.15
74LS11	35	74LS203	1.15
74LS12	35	74LS204	1.15
74LS13	35	74LS205	1.15
74LS14	35	74LS206	1.15
74LS15	35	74LS207	1.15
74LS16	35	74LS208	1.15
74LS17	35	74LS209	1.15
74LS18	35	74LS210	1.15
74LS19	35	74LS211	1.15
74LS20	35	74LS212	1.15
74LS21	35	74LS213	1.15
74LS22	35	74LS214	1.15
74LS23	35	74LS215	1.15
74LS24	35	74LS216	1.15
74LS25	35	74LS217	1.15
74LS26	35	74LS218	1.15
74LS27	35	74LS219	1.15
74LS28	35	74LS220	1.15
74LS29	35	74LS221	1.15
74LS30	35	74LS222	1.15
74LS31	35	74LS223	1.15
74LS32	35	74LS224	1.15
74LS33	35	74LS225	1.15
74LS34	35	74LS226	1.15
74LS35	35	74LS227	1.15
74LS36	35	74LS228	1.15
74LS37	35	74LS229	1.15
74LS38	35	74LS230	1.15
74LS39	35	74LS231	1.15
74LS40	35	74LS232	1.15
74LS41	35	74LS233	1.15
74LS42	35	74LS234	1.15
74LS43	35	74LS235	1.15
74LS44	35	74LS236	1.15
74LS45	35	74LS237	1.15
74LS46	35	74LS238	1.15
74LS47	35	74LS239	1.15
74LS48	1.15	74LS240	1.15
74LS49	1.15	74LS241	1.15
74LS50	35	74LS242	1.15
74LS51	35	74LS243	1.15
74LS52	35	74LS244	1.15
74LS53	35	74LS245	1.15
74LS54	35	74LS246	1.15
74LS55	35	74LS247	1.15
74LS56	35	74LS248	1.15
74LS57	35	74LS249	1.15
74LS58	35	74LS250	1.15
74LS59	35	74LS251	1.15
74LS60	35	74LS252	1.15
74LS61	35	74LS253	1.15
74LS62	35	74LS254	1.15
74LS63	35	74LS255	1.15
74LS64	35	74LS256	1.15
74LS65	35	74LS257	1.15
74LS66	35	74LS258	1.15
74LS67	35	74LS259	1.15
74LS68	35	74LS260	1.15
74LS69	35	74LS261	1.15
74LS70	35	74LS262	1.15
74LS71	35	74LS263	1.15
74LS72	35	74LS264	1.15
74LS73	35	74LS265	1.15
74LS74	35	74LS266	1.15
74LS75	35	74LS267	1.15
74LS76	35	74LS268	1.15
74LS77	35	74LS269	1.15
74LS78	35	74LS270	1.15
74LS79	35	74LS271	1.15
74LS80	35	74LS272	1.15
74LS81	35	74LS273	1.15
74LS82	35	74LS274	1.15
74LS83	35	74LS275	1.15
74LS84	35	74LS276	1.15
74LS85	35	74LS277	1.15
74LS86	35	74LS278	1.15
74LS87	35	74LS279	1.15
74LS88	35	74LS280	1.15
74LS89	35	74LS281	1.15
74LS90	35	74LS282	1.15

DISCRETE LEADS

XC556R	2001	red	5/51	MV50	0851	red	6/51
XC556G	2001	green	4/51	XC209R	1251	red	5/51
XC556V	2001	yellow	4/51	XC209G	1251	green	4/51
XC556C	2001	clear	4/51	XC209Y	1251	yellow	4/51
XC221R	2001	red	5/41	XC556R	1851	red	5/51
XC222G	2001	green	4/51	XC556G	1851	green	4/51
XC222Y	2001	yellow	4/51	XC556Y	1851	yellow	4/51
XC222C	2001	clear	4/51	XC556C	1851	clear	4/51
MV10B	1701	red	4/51				

Diffused Bi-Color LED

Part No.	1.99	100+
XC5491	79	69

CC - Common Cathode
RHD - Right Hand Decimal

DISPLAY LEADS

Type	Polarity	Ht	Price	Type	Polarity	Ht	Price
MAN 1	C.A. - red	270	2.95	DL707	C.C. - red	300	1.25
MAN 2	5x7 D.M. - red	300	9.95	DL708	C.C. - red	300	1.25
MAN 3	C.C. - red	125	25	DL721	C.C. - red	500	1.49
MAN 3	C.C. - green	300	99	DL728	C.C. - red	500	1.49
MAN 54	C.A. - green	300	99	DL741	C.C. - red	600	1.49
MAN 71	C.A. - red	300	75	DL750	C.C. - red	600	1.49
MAN 72	C.A. - red	300	75	DL0847	C.A. - orange	800	1.49
MAN 74	C.C. - red	300	1.25	DL0850	C.C. - orange	800	1.49
MAN 82	C.A. - yellow	300	49	DL318	C.C. - red	110	35
MAN 84	C.C. - yellow	300	99	FND358	C.C. - red	1	357
FMAN 3620	C.A. - orange	300	49	FND507	C.C. - red	1	357
FMAN 3630	C.A. - orange	1	300	FND500	C.C. (FND503)	500	99
FMAN 3640	C.A. - orange	300	99	FND507	C.A. (FND510)	500	99
FMAN 4610	C.A. - orange	400	99	HDSF-3401	C.C. - red	800	1.50
FMAN 6610	C.A. - orange - DD	560	99	HDSF-3403	C.C. - red	800	1.50
FMAN 6630	C.A. - orange	1	560	HDSF-3406	C.C. - red ± 1	800	1.50
FMAN 6640	C.C. - orange - DD	560	99	5082-7750	C.C. - R.H.D. - red	430	1.25
FMAN 6650	C.C. - orange	1	560	5082-7760	C.C. - R.H.D. - red	430	1.25
FMAN 6660	C.A. - orange	560	99	5082-7790	4x7 Numeric (LHD)	600	22.00
FMAN 6670	C.A. - red - DD	560	99	5082-7792	4x7 Numeric (LHD)	600	22.00
FMAN 6740	C.C. - red - DD	560	99	5082-7794	4x7 Hxdcd. (0-9/A-F)	600	22.50
FMAN 6750	C.C. - red ± 1	560	99	4N28	Photo Xisistor Opto-Isol.	69	
DLO304	C.C. - orange	300	1.25	LIT-1	Photo Xisistor Opto-Isol.	69	
DLO307	C.A. - orange	300	1.25	MOC3010	Optically Isol. Triac Driver	1.25	
DLS500	C.C. - green	500	1.25				

74C

74C00	.39	74C05	1.59	74C221	1.95
74C01	.39	74C10	1.89	74C222	2.25
74C02	.39	74C15	2.95	74C223	2.49
74C03	.39	74C16	3.95	74C224	2.49
74C04	.39	74C17	1.69	74C225	.69
74C05	.39	74C18	1.69	74C226	10.95
74C06	.39	74C19	1.69	74C227	10.95
74C07	.39	74C20	1.69	74C228	5.49
74C08	.39	74C21	1.69	74C229	5.49
74C09	.39	74C22	1.69	74C230	5.49
74C10					

ANALOG REVERB

continued from page 48

might be the case if bipolar transistors were used), and this configuration serves to split the power dissipation between the transistors and increases the transconductance (gain).

The power supplies for this unit are somewhat unusual. A separate supply is used for the power amplifier. This 25-volt supply (V_A) is formed by D3, D4, and C29 in a simple full-wave rectified unregulated supply. Since this voltage may drop considerably when driving a

speaker at high levels, separate rectifiers and filter capacitors are provided for the main supply (V_{CC}). This supply is regulated by IC12 to +18 volts.

It was found that using split supplies for the op-amps introduced excessive noise—any variation in the positive supply appeared at the outputs of the op-amps along with the signal. To eliminate this problem, an artificial "AC ground" was created that closely tracks V_{CC} . That artificial AC-ground serves two purposes. First, it is used as the ground reference for the input signal. Second, by connecting it to the "un-used" input of the op-amps, it cancels

the variations originally induced by V_{CC} .

The AC ground is generated by a resistor divider-network, R73 and R74, and applied to op-amp IC9-b. The ground is coupled closely to V_{CC} by capacitor C31. Integrated circuit IC9 is a 5532 dual op-amp, used because of its high drive-current and its high slew-rate; it reduces voltage variations much better than a voltage-regulator IC.

You should note that there is a possibility for confusing the input and output grounds. The input should be grounded to "AC ground." This provides minimum noise and is most consistent with the rest of the circuit. If the output is used to drive another amplifier or other electronic device, care must be taken because AC ground is the output of an op-amp, and only about 30 mA can be drawn from this supply.

Because of this situation, direct connection to a speaker is made to the negative supply, V_{EE} , which is 10 volts below AC ground. *The loudspeaker ground must remain isolated from the AC ground or the supply will short out!* (This will cause no damage, but will result in silence. The 5532 is fully protected against such abuse.)

The last circuit we will discuss is the one for clocking the bucket brigades. The NE556-1 (IC10) is a dual 555 timer configured in the astable (oscillator) mode. The clock signal for the main delay-line (IC3, IC4, and IC5) is produced by IC10-a and the clock signal for the feedback delay-line (IC8) is produced by IC10-b. The frequencies are determined by the values of capacitor C32 for IC10-a and C33 for IC10-b, and by the current available to charge them.

Instead of using resistors to develop charge-current, transistors Q7 and Q8 provide the currents directly. These currents are adjusted by potentiometers R64 (FEEDBACK DELAY) and R66 (DELAY). The outputs of the 556 are applied to IC11, a dual-D flip flop. The flip-flop converts the pulse outputs from the 556 to square waves of one-half the original frequency. The availability of both Q and Q outputs provides the out-of-phase square wave clock-signals needed for the bucket-brigade devices.

Now that you know how the Analog Reverberation Unit works, you probably want to know how to build one. We'll show you when we continue this article next month.

R-E

INTERNATIONAL ELECTRONICS UNLIMITED

<p>CERAMIC DISC CAPACITORS 10V</p> <table border="1"> <tr><td>1pf</td><td>47pf</td><td>220pf</td><td>.0047µf</td></tr> <tr><td>5pf</td><td>56pf</td><td>270pf</td><td>.01µf</td></tr> <tr><td>7.5pf</td><td>68pf</td><td>330pf</td><td>.015µf</td></tr> <tr><td>10pf</td><td>82pf</td><td>470pf</td><td>.022µf</td></tr> <tr><td>15pf</td><td>100pf</td><td>600pf</td><td>.030µf</td></tr> <tr><td>22pf</td><td>120pf</td><td>800pf</td><td>.040µf</td></tr> <tr><td>27pf</td><td>150pf</td><td>1000pf</td><td>.050µf</td></tr> <tr><td>33pf</td><td>180pf</td><td>1200pf</td><td>.060µf</td></tr> <tr><td colspan="4">ea pk-10 pk-100 1000-</td></tr> <tr><td colspan="4">\$.20 .95 7.00 .06ea</td></tr> </table> <p>-.1µf/50V disc 1/2" d</p> <p>\$.25 1.25 9.50 .10ea</p> <p>\$.25 1.50 3.75 .15 sq</p> <p>\$.25 1.70 15.00 .12ea</p>	1pf	47pf	220pf	.0047µf	5pf	56pf	270pf	.01µf	7.5pf	68pf	330pf	.015µf	10pf	82pf	470pf	.022µf	15pf	100pf	600pf	.030µf	22pf	120pf	800pf	.040µf	27pf	150pf	1000pf	.050µf	33pf	180pf	1200pf	.060µf	ea pk-10 pk-100 1000-				\$.20 .95 7.00 .06ea				<p>CERAMIC CAPACITOR KIT</p> <p>5 ea of above \$12.50</p> <p>10 ea of above \$20.50</p>	<p>POLYESTER FILM CAPACITORS 100V ± 10%</p> <table border="1"> <tr><td>EA:</td><td>PK-10</td><td>PK-100</td></tr> <tr><td>.001µf</td><td>\$.15</td><td>95</td><td>6.50</td></tr> <tr><td>.0015µf</td><td>\$.15</td><td>95</td><td>7.50</td></tr> <tr><td>.0022µf</td><td>\$.15</td><td>95</td><td>7.50</td></tr> <tr><td>.0033µf</td><td>\$.15</td><td>95</td><td>7.50</td></tr> <tr><td>.0047µf</td><td>\$.15</td><td>95</td><td>7.50</td></tr> <tr><td>.0068µf</td><td>\$.15</td><td>95</td><td>7.50</td></tr> <tr><td>.01µf</td><td>\$.15</td><td>95</td><td>7.50</td></tr> <tr><td>.015µf</td><td>\$.15</td><td>95</td><td>7.50</td></tr> <tr><td>.022µf</td><td>\$.15</td><td>95</td><td>7.50</td></tr> <tr><td>.033µf</td><td>\$.20</td><td>1.10</td><td>10.00</td></tr> <tr><td>.047µf</td><td>\$.20</td><td>1.10</td><td>10.50</td></tr> <tr><td>.068µf</td><td>\$.25</td><td>1.30</td><td>12.00</td></tr> <tr><td>.1µf</td><td>\$.30</td><td>1.75</td><td>13.50</td></tr> <tr><td>.15µf</td><td>\$.35</td><td>2.25</td><td>14.00</td></tr> <tr><td>.22µf</td><td>\$.40</td><td>2.55</td><td>20.00</td></tr> <tr><td>.33µf</td><td>\$.45</td><td>2.75</td><td>25.00</td></tr> <tr><td>.47µf</td><td>\$.50</td><td>3.50</td><td>30.00</td></tr> </table>	EA:	PK-10	PK-100	.001µf	\$.15	95	6.50	.0015µf	\$.15	95	7.50	.0022µf	\$.15	95	7.50	.0033µf	\$.15	95	7.50	.0047µf	\$.15	95	7.50	.0068µf	\$.15	95	7.50	.01µf	\$.15	95	7.50	.015µf	\$.15	95	7.50	.022µf	\$.15	95	7.50	.033µf	\$.20	1.10	10.00	.047µf	\$.20	1.10	10.50	.068µf	\$.25	1.30	12.00	.1µf	\$.30	1.75	13.50	.15µf	\$.35	2.25	14.00	.22µf	\$.40	2.55	20.00	.33µf	\$.45	2.75	25.00	.47µf	\$.50	3.50	30.00	<p>CARBON FILM 5% 1/4 watt (R. Ohm R25)</p> <table border="1"> <tr><td>total quantity</td><td>ea</td><td>pk-10</td><td>pk-100</td><td>pk-1000</td></tr> <tr><td>1-999</td><td>5.10</td><td>45</td><td>2.00</td><td></td></tr> <tr><td>1000-</td><td>10.00</td><td>40</td><td>1.80</td><td>15.00</td></tr> <tr><td>5000-</td><td>10.00</td><td>30</td><td>1.70</td><td>14.50</td></tr> </table>	total quantity	ea	pk-10	pk-100	pk-1000	1-999	5.10	45	2.00		1000-	10.00	40	1.80	15.00	5000-	10.00	30	1.70	14.50	<p>2708 8K EPRGM 450ns \$4.50</p> <p>2716 16K EPRGM (5V) 7.50</p> <p>3080A CPU 7.50</p> <p>1602B GRM 3.79</p> <p>5316 Alarm clock 3.25</p> <p>7010 Calendar clock 3.50</p> <p>2102 1024 bit static RAM .95</p> <p>5261 1024 bit dyn. RAM .95</p> <p>82823 256 bit PROM 3.25</p> <p>745200 256 bit PROM t-state 3.75</p> <p>P93410 256 bit RAM bi-polar .95</p> <p>2510 dual 100bit stat. S.R. .75</p> <p>2511 dual 200bit stat. S.R. .75</p> <p>2522 dual 132bit stat. S.R. .75</p> <p>2532 quad 80 bit stat. S.R. .75</p> <p>5013 1024 bit dyn. accum .75</p> <p>5016 500/512 bit dyn. .75</p> <p>8038 Function generator 3.79</p>																																																			
1pf	47pf	220pf	.0047µf																																																																																																																																																																																							
5pf	56pf	270pf	.01µf																																																																																																																																																																																							
7.5pf	68pf	330pf	.015µf																																																																																																																																																																																							
10pf	82pf	470pf	.022µf																																																																																																																																																																																							
15pf	100pf	600pf	.030µf																																																																																																																																																																																							
22pf	120pf	800pf	.040µf																																																																																																																																																																																							
27pf	150pf	1000pf	.050µf																																																																																																																																																																																							
33pf	180pf	1200pf	.060µf																																																																																																																																																																																							
ea pk-10 pk-100 1000-																																																																																																																																																																																										
\$.20 .95 7.00 .06ea																																																																																																																																																																																										
EA:	PK-10	PK-100																																																																																																																																																																																								
.001µf	\$.15	95	6.50																																																																																																																																																																																							
.0015µf	\$.15	95	7.50																																																																																																																																																																																							
.0022µf	\$.15	95	7.50																																																																																																																																																																																							
.0033µf	\$.15	95	7.50																																																																																																																																																																																							
.0047µf	\$.15	95	7.50																																																																																																																																																																																							
.0068µf	\$.15	95	7.50																																																																																																																																																																																							
.01µf	\$.15	95	7.50																																																																																																																																																																																							
.015µf	\$.15	95	7.50																																																																																																																																																																																							
.022µf	\$.15	95	7.50																																																																																																																																																																																							
.033µf	\$.20	1.10	10.00																																																																																																																																																																																							
.047µf	\$.20	1.10	10.50																																																																																																																																																																																							
.068µf	\$.25	1.30	12.00																																																																																																																																																																																							
.1µf	\$.30	1.75	13.50																																																																																																																																																																																							
.15µf	\$.35	2.25	14.00																																																																																																																																																																																							
.22µf	\$.40	2.55	20.00																																																																																																																																																																																							
.33µf	\$.45	2.75	25.00																																																																																																																																																																																							
.47µf	\$.50	3.50	30.00																																																																																																																																																																																							
total quantity	ea	pk-10	pk-100	pk-1000																																																																																																																																																																																						
1-999	5.10	45	2.00																																																																																																																																																																																							
1000-	10.00	40	1.80	15.00																																																																																																																																																																																						
5000-	10.00	30	1.70	14.50																																																																																																																																																																																						
<p>METAL FILM 1% 1/4 watt (R. Ohm CR6050) 1/4 watt</p> <table border="1"> <tr><td>total quantity</td><td>ea</td><td>pk-5</td><td>pk-10</td><td>pk-100</td></tr> <tr><td>1-999</td><td>2.25</td><td>10</td><td>2.40</td><td>7.50</td></tr> <tr><td>1000-</td><td>2.00</td><td>9.00</td><td>1.80</td><td>7.00</td></tr> <tr><td>5000-</td><td>2.00</td><td>8.50</td><td>1.70</td><td>6.50</td></tr> </table>	total quantity	ea	pk-5	pk-10	pk-100	1-999	2.25	10	2.40	7.50	1000-	2.00	9.00	1.80	7.00	5000-	2.00	8.50	1.70	6.50	<p>METAL FILM RESISTORS 1/2 watt</p> <table border="1"> <tr><td>total quantity</td><td>ea</td><td>pk-5</td><td>pk-10</td><td>pk-100</td></tr> <tr><td>1-999</td><td>2.25</td><td>10</td><td>2.40</td><td>7.50</td></tr> <tr><td>1000-</td><td>2.00</td><td>9.00</td><td>1.80</td><td>7.00</td></tr> <tr><td>5000-</td><td>2.00</td><td>8.50</td><td>1.70</td><td>6.50</td></tr> </table>	total quantity	ea	pk-5	pk-10	pk-100	1-999	2.25	10	2.40	7.50	1000-	2.00	9.00	1.80	7.00	5000-	2.00	8.50	1.70	6.50	<p>STANDARD 1% METAL FILM VALUES FROM 10 OHM TO 1.21 MOHM</p>	<p>TRANSISTORS</p> <table border="1"> <tr><td>EA</td><td>PK-10</td><td>PK-25</td><td>PK-100</td><td>1000</td></tr> <tr><td>MPS406</td><td>10-92</td><td>NPN</td><td>5.75</td><td>1.65</td><td>3.25</td><td>12.00</td><td>11ea</td></tr> <tr><td>2N2222A</td><td>10-92</td><td>NPN</td><td>30</td><td>1.75</td><td>0.00</td><td>15.00</td><td>13ea</td></tr> <tr><td>2N2222A</td><td>10-11</td><td>NPN</td><td>.45</td><td>3.50</td><td>8.00</td><td>29.00</td><td>.26ea</td></tr> <tr><td>2N3053</td><td>10-5</td><td>NPN</td><td>.55</td><td>5.00</td><td>11.75</td><td>45.00</td><td>.42ea</td></tr> <tr><td>2N3904</td><td>10-92</td><td>NPN</td><td>.25</td><td>1.65</td><td>3.25</td><td>12.00</td><td>10ea</td></tr> <tr><td>2N3906</td><td>10-92</td><td>PNP</td><td>.25</td><td>1.65</td><td>3.25</td><td>12.00</td><td>10ea</td></tr> </table>	EA	PK-10	PK-25	PK-100	1000	MPS406	10-92	NPN	5.75	1.65	3.25	12.00	11ea	2N2222A	10-92	NPN	30	1.75	0.00	15.00	13ea	2N2222A	10-11	NPN	.45	3.50	8.00	29.00	.26ea	2N3053	10-5	NPN	.55	5.00	11.75	45.00	.42ea	2N3904	10-92	NPN	.25	1.65	3.25	12.00	10ea	2N3906	10-92	PNP	.25	1.65	3.25	12.00	10ea	<p>2716 16K EPRGM (5V) 7.50</p> <p>3080A CPU 7.50</p> <p>1602B GRM 3.79</p> <p>5316 Alarm clock 3.25</p> <p>7010 Calendar clock 3.50</p> <p>2102 1024 bit static RAM .95</p> <p>5261 1024 bit dyn. RAM .95</p> <p>82823 256 bit PROM 3.25</p> <p>745200 256 bit PROM t-state 3.75</p> <p>P93410 256 bit RAM bi-polar .95</p> <p>2510 dual 100bit stat. S.R. .75</p> <p>2511 dual 200bit stat. S.R. .75</p> <p>2522 dual 132bit stat. S.R. .75</p> <p>2532 quad 80 bit stat. S.R. .75</p> <p>5013 1024 bit dyn. accum .75</p> <p>5016 500/512 bit dyn. .75</p> <p>8038 Function generator 3.79</p>																																																																																									
total quantity	ea	pk-5	pk-10	pk-100																																																																																																																																																																																						
1-999	2.25	10	2.40	7.50																																																																																																																																																																																						
1000-	2.00	9.00	1.80	7.00																																																																																																																																																																																						
5000-	2.00	8.50	1.70	6.50																																																																																																																																																																																						
total quantity	ea	pk-5	pk-10	pk-100																																																																																																																																																																																						
1-999	2.25	10	2.40	7.50																																																																																																																																																																																						
1000-	2.00	9.00	1.80	7.00																																																																																																																																																																																						
5000-	2.00	8.50	1.70	6.50																																																																																																																																																																																						
EA	PK-10	PK-25	PK-100	1000																																																																																																																																																																																						
MPS406	10-92	NPN	5.75	1.65	3.25	12.00	11ea																																																																																																																																																																																			
2N2222A	10-92	NPN	30	1.75	0.00	15.00	13ea																																																																																																																																																																																			
2N2222A	10-11	NPN	.45	3.50	8.00	29.00	.26ea																																																																																																																																																																																			
2N3053	10-5	NPN	.55	5.00	11.75	45.00	.42ea																																																																																																																																																																																			
2N3904	10-92	NPN	.25	1.65	3.25	12.00	10ea																																																																																																																																																																																			
2N3906	10-92	PNP	.25	1.65	3.25	12.00	10ea																																																																																																																																																																																			
<p>POLYESTER FILM CAPACITORS 100V ± 10%</p> <table border="1"> <tr><td>EA:</td><td>PK-10</td><td>PK-100</td></tr> <tr><td>.001µf</td><td>\$.15</td><td>95</td><td>6.50</td></tr> <tr><td>.0015µf</td><td>\$.15</td><td>95</td><td>7.50</td></tr> <tr><td>.0022µf</td><td>\$.15</td><td>95</td><td>7.50</td></tr> <tr><td>.0033µf</td><td>\$.15</td><td>95</td><td>7.50</td></tr> <tr><td>.0047µf</td><td>\$.15</td><td>95</td><td>7.50</td></tr> <tr><td>.0068µf</td><td>\$.15</td><td>95</td><td>7.50</td></tr> <tr><td>.01µf</td><td>\$.15</td><td>95</td><td>7.50</td></tr> <tr><td>.015µf</td><td>\$.15</td><td>95</td><td>7.50</td></tr> <tr><td>.022µf</td><td>\$.15</td><td>95</td><td>7.50</td></tr> <tr><td>.033µf</td><td>\$.20</td><td>1.10</td><td>10.00</td></tr> <tr><td>.047µf</td><td>\$.20</td><td>1.10</td><td>10.50</td></tr> <tr><td>.068µf</td><td>\$.25</td><td>1.30</td><td>12.00</td></tr> <tr><td>.1µf</td><td>\$.30</td><td>1.75</td><td>13.50</td></tr> <tr><td>.15µf</td><td>\$.35</td><td>2.25</td><td>14.00</td></tr> <tr><td>.22µf</td><td>\$.40</td><td>2.55</td><td>20.00</td></tr> <tr><td>.33µf</td><td>\$.45</td><td>2.75</td><td>25.00</td></tr> <tr><td>.47µf</td><td>\$.50</td><td>3.50</td><td>30.00</td></tr> </table>	EA:	PK-10	PK-100	.001µf	\$.15	95	6.50	.0015µf	\$.15	95	7.50	.0022µf	\$.15	95	7.50	.0033µf	\$.15	95	7.50	.0047µf	\$.15	95	7.50	.0068µf	\$.15	95	7.50	.01µf	\$.15	95	7.50	.015µf	\$.15	95	7.50	.022µf	\$.15	95	7.50	.033µf	\$.20	1.10	10.00	.047µf	\$.20	1.10	10.50	.068µf	\$.25	1.30	12.00	.1µf	\$.30	1.75	13.50	.15µf	\$.35	2.25	14.00	.22µf	\$.40	2.55	20.00	.33µf	\$.45	2.75	25.00	.47µf	\$.50	3.50	30.00	<p>DIODES</p> <table border="1"> <tr><td>EA</td><td>PK-10</td><td>PK-100</td></tr> <tr><td>1N3064</td><td>15/81.00</td><td>.05ea</td><td>.35ea</td></tr> <tr><td>1N4001</td><td>12/81.00</td><td>.07</td><td>.06</td></tr> <tr><td>1N4007</td><td>10/81.00</td><td>.11</td><td>.10</td></tr> <tr><td>1N4148</td><td></td><td></td><td></td></tr> <tr><td>1N914</td><td>15/81.00</td><td>.05</td><td>.04</td></tr> <tr><td>Germanium diodes</td><td>12/81.00</td><td>.07</td><td>.06</td></tr> </table>	EA	PK-10	PK-100	1N3064	15/81.00	.05ea	.35ea	1N4001	12/81.00	.07	.06	1N4007	10/81.00	.11	.10	1N4148				1N914	15/81.00	.05	.04	Germanium diodes	12/81.00	.07	.06	<p>WIRE WRAP</p> <table border="1"> <tr><td>EA</td><td>PK-10</td><td>PK-100</td></tr> <tr><td>14 pin</td><td>\$.55</td><td>\$.52</td><td>\$.49</td></tr> <tr><td>16 pin</td><td>\$.60</td><td>\$.57</td><td>\$.51</td></tr> </table>	EA	PK-10	PK-100	14 pin	\$.55	\$.52	\$.49	16 pin	\$.60	\$.57	\$.51	<p>IC10 10% OFF ON \$25.00</p> <p>15% OFF ON \$50.00</p>	<p>TRANSISTORS</p> <table border="1"> <tr><td>EA</td><td>PK-10</td><td>PK-25</td><td>PK-100</td><td>1000</td></tr> <tr><td>MPS406</td><td>10-92</td><td>NPN</td><td>5.75</td><td>1.65</td><td>3.25</td><td>12.00</td><td>11ea</td></tr> <tr><td>2N2222A</td><td>10-92</td><td>NPN</td><td>30</td><td>1.75</td><td>0.00</td><td>15.00</td><td>13ea</td></tr> <tr><td>2N2222A</td><td>10-11</td><td>NPN</td><td>.45</td><td>3.50</td><td>8.00</td><td>29.00</td><td>.26ea</td></tr> <tr><td>2N3053</td><td>10-5</td><td>NPN</td><td>.55</td><td>5.00</td><td>11.75</td><td>45.00</td><td>.42ea</td></tr> <tr><td>2N3904</td><td>10-92</td><td>NPN</td><td>.25</td><td>1.65</td><td>3.25</td><td>12.00</td><td>10ea</td></tr> <tr><td>2N3906</td><td>10-92</td><td>PNP</td><td>.25</td><td>1.65</td><td>3.25</td><td>12.00</td><td>10ea</td></tr> </table>	EA	PK-10	PK-25	PK-100	1000	MPS406	10-92	NPN	5.75	1.65	3.25	12.00	11ea	2N2222A	10-92	NPN	30	1.75	0.00	15.00	13ea	2N2222A	10-11	NPN	.45	3.50	8.00	29.00	.26ea	2N3053	10-5	NPN	.55	5.00	11.75	45.00	.42ea	2N3904	10-92	NPN	.25	1.65	3.25	12.00	10ea	2N3906	10-92	PNP	.25	1.65	3.25	12.00	10ea																				
EA:	PK-10	PK-100																																																																																																																																																																																								
.001µf	\$.15	95	6.50																																																																																																																																																																																							
.0015µf	\$.15	95	7.50																																																																																																																																																																																							
.0022µf	\$.15	95	7.50																																																																																																																																																																																							
.0033µf	\$.15	95	7.50																																																																																																																																																																																							
.0047µf	\$.15	95	7.50																																																																																																																																																																																							
.0068µf	\$.15	95	7.50																																																																																																																																																																																							
.01µf	\$.15	95	7.50																																																																																																																																																																																							
.015µf	\$.15	95	7.50																																																																																																																																																																																							
.022µf	\$.15	95	7.50																																																																																																																																																																																							
.033µf	\$.20	1.10	10.00																																																																																																																																																																																							
.047µf	\$.20	1.10	10.50																																																																																																																																																																																							
.068µf	\$.25	1.30	12.00																																																																																																																																																																																							
.1µf	\$.30	1.75	13.50																																																																																																																																																																																							
.15µf	\$.35	2.25	14.00																																																																																																																																																																																							
.22µf	\$.40	2.55	20.00																																																																																																																																																																																							
.33µf	\$.45	2.75	25.00																																																																																																																																																																																							
.47µf	\$.50	3.50	30.00																																																																																																																																																																																							
EA	PK-10	PK-100																																																																																																																																																																																								
1N3064	15/81.00	.05ea	.35ea																																																																																																																																																																																							
1N4001	12/81.00	.07	.06																																																																																																																																																																																							
1N4007	10/81.00	.11	.10																																																																																																																																																																																							
1N4148																																																																																																																																																																																										
1N914	15/81.00	.05	.04																																																																																																																																																																																							
Germanium diodes	12/81.00	.07	.06																																																																																																																																																																																							
EA	PK-10	PK-100																																																																																																																																																																																								
14 pin	\$.55	\$.52	\$.49																																																																																																																																																																																							
16 pin	\$.60	\$.57	\$.51																																																																																																																																																																																							
EA	PK-10	PK-25	PK-100	1000																																																																																																																																																																																						
MPS406	10-92	NPN	5.75	1.65	3.25	12.00	11ea																																																																																																																																																																																			
2N2222A	10-92	NPN	30	1.75	0.00	15.00	13ea																																																																																																																																																																																			
2N2222A	10-11	NPN	.45	3.50	8.00	29.00	.26ea																																																																																																																																																																																			
2N3053	10-5	NPN	.55	5.00	11.75	45.00	.42ea																																																																																																																																																																																			
2N3904	10-92	NPN	.25	1.65	3.25	12.00	10ea																																																																																																																																																																																			
2N3906	10-92	PNP	.25	1.65	3.25	12.00	10ea																																																																																																																																																																																			
<p>POLYESTER CAPACITOR KIT</p> <p>5 ea of above \$14.95</p>	<p>BEZELS WITH FILTERS</p> <p>Snap-in BEZELS of black polycarbonate thermoplastic resin. Red slide-in filter. Provides attractive finish for standard panel cut-out and displays.</p> <p>No. 140-2 12" x 12" 52.10ea</p> <p>cut-out 1.125" x 3.375" (up to .062" thick panel) viewing area 2" x 8 1/2"</p> <p>No. 140-3 12" x 12" 52.50ea</p> <p>cut-out 1.156" x 3.375" (up to .125" thick panel) viewing area 3" x 8 1/2"</p> <p>No. 140-4 12" x 12" 52.85ea</p> <p>cut-out 1.160" x 4.375" (up to .125" thick panel) viewing area 4" x 8 1/2"</p>	<p>LEDs</p> <p>jumbo diffused .20" d x .34" l</p> <table border="1"> <tr><td>EA</td><td>PK-10</td><td>PK-25</td><td>PK-100</td><td>1000-</td></tr> <tr><td>RED</td><td>\$1.00</td><td>2.25</td><td>.08ea</td><td>.078ea</td></tr> <tr><td>CLEAR</td><td>1.10</td><td>2.50</td><td>.09</td><td>.085</td></tr> <tr><td>WHITE</td><td>1.10</td><td>2.50</td><td>.09</td><td>.085</td></tr> <tr><td>YELLOW</td><td>1.40</td><td>3.25</td><td>.11</td><td>.10</td></tr> <tr><td>GREEN</td><td>1.40</td><td>3.25</td><td>.11</td><td>.10</td></tr> </table> <p>TR-State (change from red to green by reversing polarity)</p> <p>1" - 100- 1000-</p> <p>.95ea .75ea .65ea</p>	EA	PK-10	PK-25	PK-100	1000-	RED	\$1.00	2.25	.08ea	.078ea	CLEAR	1.10	2.50	.09	.085	WHITE	1.10	2.50	.09	.085	YELLOW	1.40	3.25	.11	.10	GREEN	1.40	3.25	.11	.10	<p>WIRE WRAP</p> <table border="1"> <tr><td>EA</td><td>PK-10</td><td>PK-100</td></tr> <tr><td>14 pin</td><td>\$.55</td><td>\$.52</td><td>\$.49</td></tr> <tr><td>16 pin</td><td>\$.60</td><td>\$.57</td><td>\$.51</td></tr> </table>	EA	PK-10	PK-100	14 pin	\$.55	\$.52	\$.49	16 pin	\$.60	\$.57	\$.51	<p>IC10 10% OFF ON \$25.00</p> <p>15% OFF ON \$50.00</p>	<p>TRANSISTORS</p> <table border="1"> <tr><td>EA</td><td>PK-10</td><td>PK-25</td><td>PK-100</td><td>1000</td></tr> <tr><td>MPS406</td><td>10-92</td><td>NPN</td><td>5.75</td><td>1.65</td><td>3.25</td><td>12.00</td><td>11ea</td></tr> <tr><td>2N2222A</td><td>10-92</td><td>NPN</td><td>30</td><td>1.75</td><td>0.00</td><td>15.00</td><td>13ea</td></tr> <tr><td>2N2222A</td><td>10-11</td><td>NPN</td><td>.45</td><td>3.50</td><td>8.00</td><td>29.00</td><td>.26ea</td></tr> <tr><td>2N3053</td><td>10-5</td><td>NPN</td><td>.55</td><td>5.00</td><td>11.75</td><td>45.00</td><td>.42ea</td></tr> <tr><td>2N3904</td><td>10-92</td><td>NPN</td><td>.25</td><td>1.65</td><td>3.25</td><td>12.00</td><td>10ea</td></tr> <tr><td>2N3906</td><td>10-92</td><td>PNP</td><td>.25</td><td>1.65</td><td>3.25</td><td>12.00</td><td>10ea</td></tr> </table>	EA	PK-10	PK-25	PK-100	1000	MPS406	10-92	NPN	5.75	1.65	3.25	12.00	11ea	2N2222A	10-92	NPN	30	1.75	0.00	15.00	13ea	2N2222A	10-11	NPN	.45	3.50	8.00	29.00	.26ea	2N3053	10-5	NPN	.55	5.00	11.75	45.00	.42ea	2N3904	10-92	NPN	.25	1.65	3.25	12.00	10ea	2N3906	10-92	PNP	.25	1.65	3.25	12.00	10ea																																																																																							
EA	PK-10	PK-25	PK-100	1000-																																																																																																																																																																																						
RED	\$1.00	2.25	.08ea	.078ea																																																																																																																																																																																						
CLEAR	1.10	2.50	.09	.085																																																																																																																																																																																						
WHITE	1.10	2.50	.09	.085																																																																																																																																																																																						
YELLOW	1.40	3.25	.11	.10																																																																																																																																																																																						
GREEN	1.40	3.25	.11	.10																																																																																																																																																																																						
EA	PK-10	PK-100																																																																																																																																																																																								
14 pin	\$.55	\$.52	\$.49																																																																																																																																																																																							
16 pin	\$.60	\$.57	\$.51																																																																																																																																																																																							
EA	PK-10	PK-25	PK-100	1000																																																																																																																																																																																						
MPS406	10-92	NPN	5.75	1.65	3.25	12.00	11ea																																																																																																																																																																																			
2N2222A	10-92	NPN	30	1.75	0.00	15.00	13ea																																																																																																																																																																																			
2N2222A	10-11	NPN	.45	3.50	8.00	29.00	.26ea																																																																																																																																																																																			
2N3053	10-5	NPN	.55	5.00	11.75	45.00	.42ea																																																																																																																																																																																			
2N3904	10-92	NPN	.25	1.65	3.25	12.00	10ea																																																																																																																																																																																			
2N3906	10-92	PNP	.25	1.65	3.25	12.00	10ea																																																																																																																																																																																			
<p>TANTALUM CAPACITORS solid dip - radial</p> <table border="1"> <tr><td>EA</td><td>PK-10</td><td>PK-100</td></tr> <tr><td>1µf</td><td>\$.35</td><td>30</td><td>.28</td></tr> <tr><td>2.2µf/35V</td><td>\$.35</td><td>31</td><td>.29</td></tr> <tr><td>3.3µf/35V</td><td>\$.35</td><td>31</td><td>.29</td></tr> <tr><td>1µf/50V</td><td>\$.37</td><td>32</td><td>.30</td></tr> <tr><td>1.5µf/20V</td><td>\$.37</td><td>32</td><td>.30</td></tr> <tr><td>2.2µf/20V</td><td>\$.40</td><td>35</td><td>.33</td></tr> <tr><td>3.3µf/20V</td><td>\$.45</td><td>40</td><td>.35</td></tr> <tr><td>4.7µf/16V</td><td>\$.45</td><td>40</td><td>.35</td></tr> <tr><td>4.7µf/25V</td><td>\$.50</td><td>45</td><td>.40</td></tr> <tr><td>5.6µf/10V</td><td>\$.50</td><td>45</td><td>.40</td></tr> <tr><td>6.8µf/6V</td><td>\$.50</td><td>45</td><td>.40</td></tr> <tr><td>6.8µf/18V</td><td>\$.55</td><td>50</td><td>.45</td></tr> <tr><td>10µf/20V</td><td>\$.60</td><td>55</td><td>.50</td></tr> <tr><td>15µf/6V</td><td>\$.60</td><td>50</td><td>.45</td></tr> <tr><td>15µf/20V</td><td>\$.65</td><td>55</td><td>.50</td></tr> <tr><td>22µf/10V</td><td>\$.65</td><td>55</td><td>.50</td></tr> <tr><td>22µf/16V</td><td>\$.68</td><td>57</td><td>.52</td></tr> <tr><td>33µf/6V</td><td>\$.65</td><td>55</td><td>.50</td></tr> <tr><td>33µf/10V</td><td>.70</td><td>65</td><td>.60</td></tr> <tr><td>47µf/6V</td><td>.75</td><td>70</td><td>.65</td></tr> <tr><td>56µf/5V</td><td>.85</td><td>75</td><td>.70</td></tr> <tr><td>100µf/10V</td><td>1.25</td><td>110</td><td>1.00</td></tr> </table>	EA	PK-10	PK-100	1µf	\$.35	30	.28	2.2µf/35V	\$.35	31	.29	3.3µf/35V	\$.35	31	.29	1µf/50V	\$.37	32	.30	1.5µf/20V	\$.37	32	.30	2.2µf/20V	\$.40	35	.33	3.3µf/20V	\$.45	40	.35	4.7µf/16V	\$.45	40	.35	4.7µf/25V	\$.50	45	.40	5.6µf/10V	\$.50	45	.40	6.8µf/6V	\$.50	45	.40	6.8µf/18V	\$.55	50	.45	10µf/20V	\$.60	55	.50	15µf/6V	\$.60	50	.45	15µf/20V	\$.65	55	.50	22µf/10V	\$.65	55	.50	22µf/16V	\$.68	57	.52	33µf/6V	\$.65	55	.50	33µf/10V	.70	65	.60	47µf/6V	.75	70	.65	56µf/5V	.85	75	.70	100µf/10V	1.25	110	1.00	<p>DIODES</p> <table border="1"> <tr><td>EA</td><td>PK-10</td><td>PK-100</td></tr> <tr><td>1N3064</td><td>15/81.00</td><td>.05ea</td><td>.35ea</td></tr> <tr><td>1N4001</td><td>12/81.00</td><td>.07</td><td>.06</td></tr> <tr><td>1N4007</td><td>10/81.00</td><td>.11</td><td>.10</td></tr> <tr><td>1N4148</td><td></td><td></td><td></td></tr> <tr><td>1N914</td><td>15/81.00</td><td>.05</td><td>.04</td></tr> <tr><td>Germanium diodes</td><td>12/81.00</td><td>.07</td><td>.06</td></tr> </table>	EA	PK-10	PK-100	1N3064	15/81.00	.05ea	.35ea	1N4001	12/81.00	.07	.06	1N4007	10/81.00	.11	.10	1N4148				1N914	15/81.00	.05	.04	Germanium diodes	12/81.00	.07	.06	<p>WIRE WRAP</p> <table border="1"> <tr><td>EA</td><td>PK-10</td><td>PK-100</td></tr> <tr><td>14 pin</td><td>\$.55</td><td>\$.52</td><td>\$.49</td></tr> <tr><td>16 pin</td><td>\$.60</td><td>\$.57</td><td>\$.51</td></tr> </table>	EA	PK-10	PK-100	14 pin	\$.55	\$.52	\$.49	16 pin	\$.60	\$.57	\$.51	<p>IC10 10% OFF ON \$25.00</p> <p>15% OFF ON \$50.00</p>	<p>TRANSISTORS</p> <table border="1"> <tr><td>EA</td><td>PK-10</td><td>PK-25</td><td>PK-100</td><td>1000</td></tr> <tr><td>MPS406</td><td>10-92</td><td>NPN</td><td>5.75</td><td>1.65</td><td>3.25</td><td>12.00</td><td>11ea</td></tr> <tr><td>2N2222A</td><td>10-92</td><td>NPN</td><td>30</td><td>1.75</td><td>0.00</td><td>15.00</td><td>13ea</td></tr> <tr><td>2N2222A</td><td>10-11</td><td>NPN</td><td>.45</td><td>3.50</td><td>8.00</td><td>29.00</td><td>.26ea</td></tr> <tr><td>2N3053</td><td>10-5</td><td>NPN</td><td>.55</td><td>5.00</td><td>11.75</td><td>45.00</td><td>.42ea</td></tr> <tr><td>2N3904</td><td>10-92</td><td>NPN</td><td>.25</td><td>1.65</td><td>3.25</td><td>12.00</td><td>10ea</td></tr> <tr><td>2N3906</td><td>10-92</td><td>PNP</td><td>.25</td><td>1.65</td><td>3.25</td><td>12.00</td><td>10ea</td></tr> </table>	EA	PK-10	PK-25	PK-100	1000	MPS406	10-92	NPN	5.75	1.65	3.25	12.00	11ea	2N2222A	10-92	NPN	30	1.75	0.00	15.00	13ea	2N2222A	10-11	NPN	.45	3.50	8.00	29.00	.26ea	2N3053	10-5	NPN	.55	5.00	11.75	45.00	.42ea	2N3904	10-92	NPN	.25	1.65	3.25	12.00	10ea	2N3906	10-92	PNP	.25	1.65	3.25	12.00	10ea
EA	PK-10	PK-100																																																																																																																																																																																								
1µf	\$.35	30	.28																																																																																																																																																																																							
2.2µf/35V	\$.35	31	.29																																																																																																																																																																																							
3.3µf/35V	\$.35	31	.29																																																																																																																																																																																							
1µf/50V	\$.37	32	.30																																																																																																																																																																																							
1.5µf/20V	\$.37	32	.30																																																																																																																																																																																							
2.2µf/20V	\$.40	35	.33																																																																																																																																																																																							
3.3µf/20V	\$.45	40	.35																																																																																																																																																																																							
4.7µf/16V	\$.45	40	.35																																																																																																																																																																																							
4.7µf/25V	\$.50	45	.40																																																																																																																																																																																							
5.6µf/10V	\$.50	45	.40																																																																																																																																																																																							
6.8µf/6V	\$.50	45	.40																																																																																																																																																																																							
6.8µf/18V	\$.55	50	.45																																																																																																																																																																																							
10µf/20V	\$.60	55	.50																																																																																																																																																																																							
15µf/6V	\$.60	50	.45																																																																																																																																																																																							
15µf/20V	\$.65	55	.50																																																																																																																																																																																							
22µf/10V	\$.65	55	.50																																																																																																																																																																																							
22µf/16V	\$.68	57	.52																																																																																																																																																																																							
33µf/6V	\$.65	55	.50																																																																																																																																																																																							
33µf/10V	.70	65	.60																																																																																																																																																																																							
47µf/6V	.75	70	.65																																																																																																																																																																																							
56µf/5V	.85	75	.70																																																																																																																																																																																							
100µf/10V	1.25	110	1.00																																																																																																																																																																																							
EA	PK-10	PK-100																																																																																																																																																																																								
1N3064	15/81.00	.05ea	.35ea																																																																																																																																																																																							
1N4001	12/81.00	.07	.06																																																																																																																																																																																							
1N4007	10/81.00	.11	.10																																																																																																																																																																																							
1N4148																																																																																																																																																																																										
1N914	15/81.00	.05	.04																																																																																																																																																																																							
Germanium diodes	12/81.00	.07	.06																																																																																																																																																																																							
EA	PK-10	PK-100																																																																																																																																																																																								
14 pin	\$.55	\$.52	\$.49																																																																																																																																																																																							
16 pin	\$.60	\$.57	\$.51																																																																																																																																																																																							
EA	PK-10	PK-25	PK-100	1000																																																																																																																																																																																						
MPS406	10-92	NPN	5.75	1.65	3.25	12.00	11ea																																																																																																																																																																																			
2N2222A	10-92	NPN	30	1.75	0.00	15.00	13ea																																																																																																																																																																																			
2N2222A	10-11	NPN	.45	3.50	8.00	29.00	.26ea																																																																																																																																																																																			
2N3053	10-5	NPN	.55	5.00	11.75	45.00	.42ea																																																																																																																																																																																			
2N3904	10-92	NPN	.25	1.65	3.25	12.00	10ea																																																																																																																																																																																			
2N3906	10-92	PNP	.25	1.65	3.25	12.00	10ea																																																																																																																																																																																			
<p>ELECTROLYTIC CAPACITORS axial leads</p> <table border="1"> <tr><td>EA</td><td>PK-10</td><td>PK-100</td></tr> <tr><td>1µf/50V</td><td>\$.15</td><td>12</td><td>.10</td></tr> <tr><td>2.2µf/35V</td><td>\$.18</td><td>15</td><td>.13</td></tr> <tr><td>4.7µf/35V</td><td>\$.18</td><td>15</td><td>.13</td></tr> <tr><td>10µf/16V</td><td>\$.15</td><td>13</td><td>.12</td></tr> <tr><td>10µf/16V</td><td>\$.18</td><td>15</td><td>.13</td></tr> <tr><td>20µf/25V</td><td>\$.17</td><td>14</td><td>.12</td></tr> <tr><td>47µf/25V</td><td>\$.18</td><td>16</td><td>.13</td></tr> <tr><td>80µf/40V</td><td>\$.15</td><td>13</td><td>.11</td></tr> <tr><td>100µf/25V</td><td>\$.18</td><td>16</td><td>.14</td></tr> <tr><td>220µf/25V</td><td>\$.25</td><td>22</td><td>.20</td></tr> <tr><td>470µf/25V</td><td>\$.33</td><td>28</td><td>.25</td></tr> <tr><td>1000µf/16V</td><td>\$.85</td><td>80</td><td>.75</td></tr> </table>	EA	PK-10	PK-100	1µf/50V	\$.15	12	.10	2.2µf/35V	\$.18	15	.13	4.7µf/35V	\$.18	15	.13	10µf/16V	\$.15	13	.12	10µf/16V	\$.18	15	.13	20µf/25V	\$.17	14	.12	47µf/25V	\$.18	16	.13	80µf/40V	\$.15	13	.11	100µf/25V	\$.18	16	.14	220µf/25V	\$.25	22	.20	470µf/25V	\$.33	28	.25	1000µf/16V	\$.85	80	.75	<p>LEDs</p> <p>jumbo diffused .20" d x .34" l</p> <table border="1"> <tr><td>EA</td><td>PK-10</td><td>PK-25</td><td>PK-100</td><td>1000-</td></tr> <tr><td>RED</td><td>\$1.00</td><td>2.25</td><td>.08ea</td><td>.078ea</td></tr> <tr><td>CLEAR</td><td>1.10</td><td>2.50</td><td>.09</td><td>.085</td></tr> <tr><td>WHITE</td><td>1.10</td><td>2.50</td><td>.09</td><td>.085</td></tr> <tr><td>YELLOW</td><td>1.40</td><td>3.25</td><td>.11</td><td>.10</td></tr> <tr><td>GREEN</td><td>1.40</td><td>3.25</td><td>.11</td><td>.10</td></tr> </table> <p>TR-State (change from red to green by reversing polarity)</p> <p>1" - 100- 1000-</p> <p>.95ea .75ea .65ea</p>	EA	PK-10	PK-25	PK-100	1000-	RED	\$1.00	2.25	.08ea	.078ea	CLEAR	1.10	2.50	.09	.085	WHITE	1.10	2.50	.09	.085	YELLOW	1.40	3.25	.11	.10	GREEN	1.40	3.25	.11	.10	<p>WIRE WRAP</p> <table border="1"> <tr><td>EA</td><td>PK-10</td><td>PK-100</td></tr> <tr><td>14 pin</td><td>\$.55</td><td>\$.52</td><td>\$.49</td></tr> <tr><td>16 pin</td><td>\$.60</td><td>\$.57</td><td>\$.51</td></tr> </table>	EA	PK-10	PK-100	14 pin	\$.55	\$.52	\$.49	16 pin	\$.60	\$.57	\$.51	<p>IC10 10% OFF ON \$25.00</p> <p>15% OFF ON \$50.00</p>	<p>TRANSISTORS</p> <table border="1"> <tr><td>EA</td><td>PK-10</td><td>PK-25</td><td>PK-100</td><td>1000</td></tr> <tr><td>MPS406</td><td>10-92</td><td>NPN</td><td>5.75</td><td>1.65</td><td>3.25</td><td>12.00</td><td>11ea</td></tr> <tr><td>2N2222A</td><td>10-92</td><td>NPN</td><td>30</td><td>1.75</td><td>0.00</td><td>15.00</td><td>13ea</td></tr> <tr><td>2N2222A</td><td>10-11</td><td>NPN</td><td>.45</td><td>3.50</td><td>8.00</td><td>29.00</td><td>.26ea</td></tr> <tr><td>2N3053</td><td>10-5</td><td>NPN</td><td>.55</td><td>5.00</td><td>11.75</td><td>45.00</td><td>.42ea</td></tr> <tr><td>2N3904</td><td>10-92</td><td>NPN</td><td>.25</td><td>1.65</td><td>3.25</td><td>12.00</td><td>10ea</td></tr> <tr><td>2N3906</td><td>10-92</td><td>PNP</td><td>.25</td><td>1.65</td><td>3.25</td><td>12.00</td><td>10ea</td></tr> </table>	EA	PK-10	PK-25	PK-100	1000	MPS406	10-92	NPN	5.75	1.65	3.25	12.00	11ea	2N2222A	10-92	NPN	30	1.75	0.00	15.00	13ea	2N2222A	10-11	NPN	.45	3.50	8.00	29.00	.26ea	2N3053	10-5	NPN	.55	5.00	11.75	45.00	.42ea	2N3904	10-92	NPN	.25	1.65	3.25	12.00	10ea	2N3906	10-92	PNP	.25	1.65	3.25	12.00	10ea																																					
EA	PK-10	PK-100																																																																																																																																																																																								
1µf/50V	\$.15	12	.10																																																																																																																																																																																							
2.2µf/35V	\$.18	15	.13																																																																																																																																																																																							
4.7µf/35V	\$.18	15	.13																																																																																																																																																																																							
10µf/16V	\$.15	13	.12																																																																																																																																																																																							
10µf/16V	\$.18	15	.13																																																																																																																																																																																							
20µf/25V	\$.17	14	.12																																																																																																																																																																																							
47µf/25V	\$.18	16	.13																																																																																																																																																																																							
80µf/40V	\$.15	13	.11																																																																																																																																																																																							
100µf/25V	\$.18	16	.14																																																																																																																																																																																							
220µf/25V	\$.25	22	.20																																																																																																																																																																																							
470µf/25V	\$.33	28	.25																																																																																																																																																																																							
1000µf/16V	\$.85	80	.75																																																																																																																																																																																							
EA	PK-10	PK-25	PK-100	1000-																																																																																																																																																																																						
RED	\$1.00	2.25	.08ea	.078ea																																																																																																																																																																																						
CLEAR	1.10	2.50	.09	.085																																																																																																																																																																																						
WHITE	1.10	2.50	.09	.085																																																																																																																																																																																						
YELLOW	1.40	3.25	.11	.10																																																																																																																																																																																						
GREEN	1.40	3.25	.11	.10																																																																																																																																																																																						
EA	PK-10	PK-100																																																																																																																																																																																								
14 pin	\$.55	\$.52	\$.49																																																																																																																																																																																							
16 pin	\$.60	\$.57	\$.51																																																																																																																																																																																							
EA	PK-10	PK-25	PK-100	1000																																																																																																																																																																																						
MPS406	10-92	NPN	5.75	1.65	3.25	12.00	11ea																																																																																																																																																																																			
2N2222A	10-92	NPN	30	1.75	0.00	15.00	13ea																																																																																																																																																																																			
2N2222A	10-11	NPN	.45	3.50	8.00	29.00	.26ea																																																																																																																																																																																			
2N3053	10-5	NPN	.55	5.00	11.75	45.00	.42ea																																																																																																																																																																																			
2N3904	10-92	NPN	.25	1.65	3.25	12.00	10ea																																																																																																																																																																																			
2N3906	10-92	PNP	.25	1.65	3.25	12.00	10ea																																																																																																																																																																																			
<p>ELECTROLYTIC CAPACITORS axial leads</p> <table border="1"> <tr><td>EA</td><td>PK-10</td><td>PK-100</td></tr> <tr><td>1µf/50V</td><td>\$.15</td><td>12</td><td>.10</td></tr> <tr><td>2.2µf/35V</td><td>\$.18</td><td>15</td><td>.13</td></tr> <tr><td>4.7µf/35V</td><td>\$.18</td><td>15</td><td>.13</td></tr> <tr><td>10µf/16V</td><td>\$.15</td><td>13</td><td>.12</td></tr> <tr><td>10µf/16V</td><td>\$.18</td><td>15</td><td>.13</td></tr> <tr><td>20µf/25V</td><td>\$.17</td><td>14</td><td>.12</td></tr> <tr><td>47µf/25V</td><td>\$.18</td><td>16</td><td>.13</td></tr> <tr><td>80µf/40V</td><td>\$.15</td><td>13</td><td>.11</td></tr> <tr><td>100µf/25V</td><td>\$.18</td><td>16</td><td>.14</td></tr> <tr><td>220µf/25V</td><td>\$.25</td><td>22</td><td>.20</td></tr> <tr><td>470µf/25V</td><td>\$.33</td><td>28</td><td>.25</td></tr> <tr><td>1000µf/16V</td><td>\$.85</td><td>80</td><td>.75</td></tr> </table>	EA	PK-10	PK-100	1µf/50V	\$.15	12	.10	2.2µf/35V	\$.18	15	.13	4.7µf/35V	\$.18	15	.13	10µf/16V	\$.15	13	.12	10µf/16V	\$.18	15	.13	20µf/25V	\$.17	14	.12	47µf/25V	\$.18	16	.13	80µf/40V	\$.15	13	.11	100µf/25V	\$.18	16	.14	220µf/25V	\$.25	22	.20	470µf/25V	\$.33	28	.25	1000µf/16V	\$.85	80	.75	<p>LEDs</p>																																																																																																																																						
EA	PK-10	PK-100																																																																																																																																																																																								
1µf/50V	\$.15	12	.10																																																																																																																																																																																							
2.2µf/35V	\$.18	15	.13																																																																																																																																																																																							
4.7µf/35V	\$.18	15	.13																																																																																																																																																																																							
10µf/16V	\$.15	13	.12																																																																																																																																																																																							
10µf/16V	\$.18	15	.13																																																																																																																																																																																							
20µf/25V	\$.17	14	.12																																																																																																																																																																																							
47µf/25V	\$.18	16	.13																																																																																																																																																																																							
80µf/40V	\$.15	13	.11																																																																																																																																																																																							
100µf/25V	\$.18	16	.14																																																																																																																																																																																							
220µf/25V	\$.25	22	.20																																																																																																																																																																																							
470µf/25V	\$.33	28	.25																																																																																																																																																																																							
1000µf/16V	\$.85	80	.75																																																																																																																																																																																							

100W CLASS A POWER AMP KIT

Dynamic Bias Class "A" circuit design makes this unit unique in its class. Crystal clear, 100 watts power output will satisfy the most picky fans. A perfect combination with the TA-1020 low T.I.M. stereo pre-amp.

Specifications:

- Output power: 100W RMS into 8-ohm 125W RMS into 4-ohm
- Frequency response: 10Hz - 100 KHz
- T.H.D.: less than 0.008%
- S/N ratio: better than 80dB
- Input sensitivity: IV max.
- Power supply: ±40V @ 5 amp
- One channel



TA-1000 KIT
\$51.95
Power transformer
\$18.00 each

REGULATED VARIABLE D.C. POWER SUPPLY KIT

Uses UA723 I.C. and 2N3055 power transistor as regulator. Output voltages can be adjusted from 0-30V at an internal resistance of less than 0.005 ohm; ripple and noise less than 1 mV; with built on board LED and audible overload indicator. Kit comes with P.C. board; all electronic components, transformer, connectors; 2 panel meters for voltage and amp; a professional look metal cabinet and instructions.

Model TR-88A 0-15V D.C. 3 amp
Model TR-88B 0-30V D.C. 2 amp



\$59.50 per kit



WHISTLE ACTIVATED SWITCH BOARD

All boards are pre-assembled and tested. Your whistle to its FET condenser microphone from a distance, as far as 30 feet away (sensitivity can be easily adjusted) will turn the switch on, then latched you whistle to it again then it turns off. Ideal for remote control toys, electrical appliance such as lights, coffee pots, TV, Hi-Fi, radio or other projects. Unit works on 9V D.C.



Model 968
\$4.50 each

SUB MINI SIZE FET CONDENSER MICROPHONE

Specification:

Sensitivity: -65dB ± 3dB
FEO. Response: 50 Hz - 8 KHz
Output Impedance: 1K ohm max.
Polar Pattern: Omni-directional
Power Supply: 1.5V - 10V D.C.
Sound Pressure Level: Max. 120dB
EM4RP \$2.50 ea. or 2 for \$4.50



NEW MARK III 9 Steps 4 Colors LED VU

Stereo level indicator kit with arc-shape display panel!!! This Mark III LED level indicator is a new design PC board with an arc-shape 4 colors LED display (change color from red, yellow, green and the peak output indicated by rose). The power range is very large, from -30dB to +5dB. The Mark III indicator is applicable to 1 watt - 200 watts amplifier operating voltage is 3V - 9V DC at max 400 MA. The circuit uses 10 LEDs per channel. It is very easy to connect to the amplifier. Just hook up with the speaker output!

IN KIT FORM \$18.50

2 WATT AUDIO AMP

Pre assembled units. All you need is to hook up the speaker and the volume control. Supply voltage from 9-15V D.C. measures only 2" x 3 1/2", making it good for portable or discrete applications. Comes with hook up data.



BUY 2 FOR \$4.99

MARK IV 15 STEPS LED POWER LEVEL INDICATOR KIT

This new stereo level indicator kit consists of 36 4-color LED (15 per channel) to indicate the sound level output of your amplifier from -36dB ~ +3dB. Comes with a well-designed silk screen printed plastic panel and has a selector switch to allow floating or gradual output indicating. Power supply is 6 ~ 12V D.C. with THG on board input sensitivity controls. This unit can work with any amplifier from 1W to 200W!

Kit includes 70 pcs. driver transistors, 38 pcs. matched 4-color LED, all other electronic components, PC board and front panel.



MARK IV KIT \$31.50

MARK V 15 STEPS LED POWER OUTPUT INDICATOR KIT

All functions same as Mark IV but this is with heavy duty aluminum front plate and case. Can be easily slot into the front panel of your auto, truck or boat. Operates on 12V DC.



\$41.50 EACH KIT

BATTERY POWERED FLUORESCENT LANTERN

MODEL 888 R

FEATURES

- Circuitry: designed for operation by high efficient, high power silicon transistor which enable illumination maintain in a standard level even the battery supply drops to a certain low voltage.
- 9" 6W cool/daylight miniature fluorescent tube.
- 8 x 1.5V UM-1 (size D) dry cell battery.
- Easy sliding door for changing batteries.
- Stainless reflector with wide angle increasing illumination of the lantern.



\$10.50 EA

30W + 30W STEREO HYBRID AMPLIFIER KIT

Kit includes 1 PC SANYO STK-043 stereo power amp IC LM 1458 as pre amp, all other electronic parts, PC Board, all control pots and special heat sink for hybrid. Power transformer not included. It produces ultra hi-fi output up to 60 watts (30 watts per channel) yet gives out less than 0.1% total harmonic distortion between 100MHz and 10KHz.



\$32.50 PER KIT

5W AUDIO AMP KIT

2 LM 380 with Volume Control
Power Supply 6 18V DC
ONLY \$6.00 EACH



TWO IN ONE PANEL METER D.C. VOLTAGE AND AMP IN ONE

D.C. Volts reads 0-50
D.C. Amp reads 0-3
Meter case made of black plastic with a white scale plate and glass window.



#ST-680 \$12.50 EACH

SPECIAL 0.5" LED SALE ALARM CLOCK MODULE

ASSEMBLED! NOT A KIT!
Features: • 4 digits 0.5" LED Displays • 12 hours real time format • 24 hours alarm audio output • 59 min. countdown timer • 10 min. snooze control.



ONLY \$7.00 EACH
SPECIAL TRANSFORMER FOR CLOCK \$2.50

CUBO CLOCK CASES

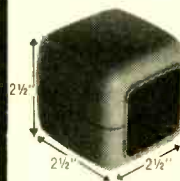

All brand new top quality plastic cases, originally designed for Cubo clocks. Case comes with top and bottom cover with a detachable front red filter for LED readouts. This can be used for many projects such as LED CLOCK, VU METER, LIGHT BOX, FREQ. COUNTER, ETC.
3 Attractive Colors (white, lime green or orange)

BUY 3 FOR ONLY \$2.50

TV GAME BOARD

PLAYS 4 GAMES: TENNIS, HOCKEY, HANDBALL AND JAI-ALAI.

All boards complete with all parts ready to play. Requires 6C size batteries and a small speaker for sound effects. The boards were surplus from a famous game manufacturer. They will play on all US standard black and white or color TV sets.

Regular price for these games were \$39.50 each
OUR PRICE ONLY \$6.50 EACH



PART #57456

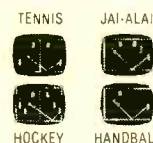

TENNIS JAI-ALAI
HOCKEY HANDBALL

MULTI-FINS HEAT SINK

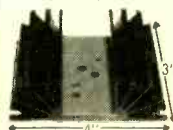

Ideal for high power output. Holes predrilled for 1 to 3 transistor. Made of aluminum with ten radiating fins.

2 FOR \$4.50

PROFESSIONAL FM WIRELESS MICROPHONE

TECT model WEM-16 is a factory assembled FM wireless microphone powered by an AA size battery. Transmits in the range of 88-108MHz with 3 transistor circuits and an omni-directional electric condenser. Element built-in plastic tube type case; mike is 6 1/4" long. With a standard FM radio, can be heard anywhere on a one-acre lot; sound quality was judged very good.

\$16.50



FOR 'BOX' BUILDERS

Pre-Drilled PC Board	\$17.50
Toliod Coils (Set of 4)	\$ 3.00
Multi Turn Trim-Pots 10K ohm	\$ 2.50
Trimmer Capacitor 6-35pF	\$ 0.60
MC1358	\$ 2.00
MC1350	\$ 2.50
MC1330	\$ 3.50
RC1458	\$ 1.00
LM380	\$ 1.80
LM340T-15	\$ 1.20
NE565	\$ 2.00

We also have transformer, capacitors set, resistors set antenna transformer. Please call for price.

LCD CLOCK MODULE!

• 0.5" LCD 4 digits display • X'tal controlled circuits • D.C. powered (1.5V battery) - 12 hr. or 24 hr. display • 24 hr. alarm set • 60 min. countdown timer • On board dual back-up lights • Dual time zone display • Stop watch function.

NIC1200 (12 hr) ON SALE
NIC2400 (24 hr) \$16.99 EACH

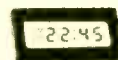

SANYO UHF VARACTOR TUNER

For UHF CH 14 ~ 83
Tuning voltage + 1V ~ + 28V D.C. Input impedance 75 OHM. I.F. band width 7 ~ 16 MHz. Noise figure 11.5 dB. MAX. Size 2 1/4" x 1 1/4" x 3/4". Supply voltage 15V D.C. Sound I.F. = 58.0 MHz. Video I.F. = 62.5 MHz



All units are brand new from Sanyo.
MODEL 115-B-405A
\$35.00 EACH

FLUORESCENT LIGHT DRIVER KIT



With Case Only
\$6.50 Per Kit

12V DC POWERED
Lights up 8 ~ 15 Watt Fluorescent Light Tubes. Ideal for camper, outdoor, auto or boat. Kit includes high voltage coil, power transistor, heat sink, all other electronic parts and PC Board, light tube not included!

SUPER FM WIRELESS MIC KIT — MARK III



FMC-105
\$11.50 PER KIT

This new designed circuit uses high FET transistors with 2 stages pre amp. Transmits FM Range (88-120 MHz) up to 2 blocks away and with the ultra sensitive condenser microphone that comes with the kit, allows you to pick up any sound within 15 ft. away! Kit includes all electronic parts, OSC coils, and P.C. Board. Power supply 9V D.C.

PRESS-A-LIGHT SELF GENERATED FLASHLIGHT

EXCLUSIVE!! \$3.95 ea
Model F-179



Never worry about battery, because it has none! Easy to carry in pocket and handy to use. Ideal for emergency light. It generates its own electricity by squeezing grip lever. Put one in your car, boat, camper or home. You may need it some time!

ELECTRONIC DUAL SPEAKER PROTECTOR



Cut off when circuit is shorted or over load to protect your amplifier as well as your speakers. A must for OCL circuits.

KIT FORM
\$8.75 EA.

"FISHER" 30 WATT STEREO AMP



Super Buy
Only \$18.50

MAIN AMP (15W x 2)
Kit includes 2 pcs. Fisher PA 301 Hybrid IC all electronic parts with PC Board. Power supply ± 16V DC (not included). Power band with (KF 1% ± 3dB). Voltage gain 33dB. 20Hz - 20KHz.

SPACE WAR SOUND GENERATOR BOARD



Brand new preassembled module for a toy factory. The board gives out 6 different selectable space sound with LED light effect. Sounds include UFO take-off, space gun blast, wave, and space chime. 7 LED on the board will work with the sound. Requires 9V battery to operate. Speaker not included.
SPECIAL \$3.99 EACH SPEAKER \$1.25 EACH

ELECTRONIC PIEZO BEEP BUZZER



Unique surplus 7/8" Dia. piezo ceramic disc on circuit board gives a distinct high freq. buzz. Unit contains an I.C., 2 caps, 6 resistors and is already preassembled. Requires 9V battery to operate.
SPECIAL 2 FOR \$2.99

2 BIT COUNTER, WARBLE PULSE ALARM BOARD



This new assembly easily converts to a counter, stop watch, warble and pulse alarm generator by adding a few components. We supply the data and typical applications. Requires 9V battery to operate.
SPECIAL 2 FOR \$1.99

AUDIO OUTPUT dB METER



Meter made of clear plastic with a silver white face plate. Scale reads from -20 +3dB. Meter also comes with an internal dial light.
MODEL: 6F-3
\$6.50 EACH

BATTERIES

PK/\$10.00
2 PKS/\$19.00



NICKEL CADMIUM BATTERY PACK 'D' SIZE

ILLUSTRATED LESS COVER

Output: 3.6 Volts @ 3.0 Amp/Hour. Consists of three each, 1.2 Volt "D" size Nickel Cadmium Cells stacked and plastic film encapsulated. Tabs are provided at each end for electrical connections. The individual cells can be cut apart if desired. Rated recharge rate is 30 mA, 14-18 hours. Size: 1 1/4" dia. x 7" long. New. Shpg. Wt. each pack, 1 lb.

9V RECHARGEABLE NI-CD BATTERY



Replace all 006P type 9V battery
Model: GC9

BRAND NEW \$4.50 EACH

NI-CD BATTERY SALE



12V Pack 450 MZ/HR Size 3" x 1" x 2" \$8.00 PER PACK

4 AA Pack 450 MA/HR \$3.50 PER PACK

All above batteries are used but late date code and we guarantee to take back all bad ones for exchange.

GELCELL 6V 9AMP/HR SEALED LEAD ACID RECHARGEABLE BATTERY

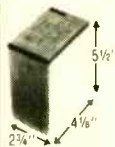

Sealed construction permits this battery to be operated in any position. Recharge rate 2.15 amp max. for 14-16 hours. All brand new. Limited quantities. Size of battery 4 1/8" x 2 3/4" x 5 1/2".

\$16.50 each

ELECTRONIC PIN BALL MACHINE



That sounds and plays like the real thing. All units are brand new but without the case. Functions of the game include double flipper control, kicker control, 1-4 players, 3 speed ball control, hit switch, automatic score, extra bonus cave and many more. All solid state with LED panel, no moving parts. Requires 9V battery to operate, speaker not included.

A perfect gift for yourself or friends.

SPECIAL \$6.99 EACH
SPEAKER \$1.25 EACH

ULTRASONIC SWITCH KIT



Kit includes the Ultra Sonic Transducers, 2 PC Boards for transmitter and receiver. All electronic parts and instructions. Easy to build and a lot of uses such as remote control for TV, garage door, alarm system or counter. Unit operates by 9-12 DC. \$15.50

TOUCH TONE TYPE SLIM TELEPHONE KEY PAD



Weather proof plastic one piece key-tops. Key numbers from 1-0. All switches momentary. Open one side not connected one side common. \$3.50 EACH

SOUND ACTIVATED SWITCH



All parts completed on a PC Board SCR will turn on relay, buzzer or trigger other circuit for 2 - 10 sec. (adjustable). Ideal for use as door alarm, sound controlled toys and many other projects. Supply voltage 4.5V 9V D.C. 2 for \$3.00

REGULATED DUAL VOLTAGE SUPPLY KIT

±4 30V DC 800 MA adjustable, fully regulated by Fairchild 78MG and 79MG voltage regulator I.C. Kit includes all electronic parts, filter capacitors, I.C., heat sinks and P.C. board.



\$12.50 PER KIT

AA SIZE NI-CD SPECIAL SALE

RECHARGEABLE BATTERIES LIMITED QUANTITY AVAILABLE

4 FOR \$6.00

CRYSTAL CONTROLLED WIRELESS MICROPHONE SYSTEM



No FCC license required
OUR PRICE \$49.50
ADDITIONAL MICROPHONE (TRANSMITTER) AVAILABLE AT \$28.00 EACH

Transmitter: FET mic for flat 30-18 KHz response extra controlled 49 MHz AM Band for drift-free performance. 100 MW output (range approx. 1/4 mile) for reliable long range transmission. Powered by a 9V radio battery (included)
Receiver: Extra controlled locks on 49 MHz transmitter signal. With on panel VU meter monitors the signal strength from the microphone. Standard phone jack outlet connection to a PA or other phone input. 9V battery included. This professional set is ideal for on stage, in field, church, in house or outdoor use.

MURA WMS-49

POWER SUPPLY KIT

0-30V D.C. REGULATED
Uses UA723 and ZN3055 Power TR output can be adjusted from 0-30V, 2 AMP. Complete with PC board and all electronic parts. Transformer for Power Supply. 2 AMP 24V x 2 \$8.50



0-30 Power Supply \$10.50 each

FLASHER LED

Unique design combines a jumbo red LED with an IC flasher chip in one package. Operates directly from 5V-7V DC. No dropping resistor needed. Pulse rate 3Hz @ 5V 20mA.

2 for \$2.20

BIPOLAR LED RED/GREEN

2 colors in one LED, green and red, changes color when reverse voltage supply. Amazing!
2 FOR \$2.20

ELECTRONIC SWITCH KIT

CONDENSER TYPE Touch On Touch Off uses 7473 I.C. and 12V relay \$5.50 each



1 WATT AUDIO AMP

All parts are pre-assembled on a mini PC Board. Supply Voltage 6 9V D.C. SPECIAL PRICE \$1.95 ea.



LOW TIM DC STEREO PRE-AMP KIT TA-10 20

Incorporates brand-new D.C. design that gives a frequency response from 0Hz - 100KHz ±0.5dB! Added features like tone defeat and loudness control let you tailor your own frequency supplies to eliminate power fluctuation!

Specifications: • T.H.D. less than .005% • T.I.M. less than .005% • Frequency response: DC to 100KHz ±0.5dB • RIAA deviation: ±0.2dB • S/N ratio: better than 70dB • Sensitivity: Phono 2MV 47K/Aux. 100MV 100K • Output level: 1.3V • Max. output: 15V • Tone control: bass ±10dB @ 50Hz/treble ±10dB @ 15Hz • Power supply: ±24 D.C. @ 0.5A
Kit comes with regulated power supply, all you need is a 48V C.T. transformer @ 0.5A

ONLY \$44.50
X'former \$4.50 ea.



FORMULA INTERNATIONAL INC.

9/81

	SHIPPING AND HANDLING CHARGES
Inside California	Under \$50.00 purchase Over \$50.00 purchase
Outside California (includes Mexico & Canada)	Under \$50.00 purchase Over \$50.00 purchase
Overseas	Under \$50.00 purchase Over \$50.00 purchase

Minimum Order \$18.00/C. All Residents Add 6% Sales Tax
Phone Orders Accepted on Visa or MC ONLY, NO C.O.D./Store Hours 10-7 Mon. thru Sat.

Send \$1.00 For Detailed Catalogue

12603 CRENSHAW BLVD., HAWTHORNE, CA 90250
PHONE: (213) 973-1921 • (213) 879-5182

KNAPP ELECTRONIC PARTS

FOR SALE

TV projection lenses. Create your own TV projection system using our lenses. **Free information.** SOLAR OPTICS LAB, 2046 Barks St., Flint, MI 48503

RF power transistors—tubes—special parts for "ham" linears. MRF454 \$17.00, MRF455A \$14.00, 8950 \$9.00, 6LF6 \$5.50, catalog and cross-reference help available. COD—Visa/MC. WESTCOM 1320 Grand, San Marcos, CA 92069. (714) 744-0728

COMPLETE line of microwave television converters and accessories to suit your needs. Converters have a one year warranty backed by a 3 year reputation. Call or write for complete specifications and pricing. **Dealer inquiries invited.** TRITON MARKETING, 1933 Rockaway Parkway, Brooklyn, NY 11236 (212) 531-9004

NOSTALGIA crystal radio. Expertly handcrafted. Traditional style. Assembled and tested. Write for information. BOB RYAN, P.O. Box 3039, Anaheim, CA 92803

SCANNER monitor accessories—kits and factory assembled. Free catalog. CAPRL ELECTRONICS, Route 1R, Canon, GA 30520

SAMS, complete set through 2025 with seven heavy duty cabinets, excellent condition \$4,250.00, plus complete TV shop of nearly new test equipment at bargain prices. Phone 918-690-3393 or write: 5480 S. Waco, Aurora, CO 80015

RECONDITIONED test equipment. \$1.00 for catalog—JAMES WALTER TEST EQUIPMENT, 2697 Nickel, San Pablo, CA 94806

2150 megahertz downconverters \$99.95 up, assembled. Details for SASE. GW ELECTRONICS, POB 688, Greenwood, IN 46142

SEVEN new unused mini-computer units. Each includes color display monitor, keyboard, disc drive, power pack, cpu, Diablo Hy-type printer, more. Consider any reasonable offer. CLAREMONT COLLEGES, 747 N. Dartmouth, Claremont, CA 91711 Attn: R. Kemmerer

RESISTORS 1/4W, 1/2W 5% carbon films 3¢ ea. No minimums. 1% metal films. Send for details. Bulk pricing available. JR INDUSTRIES, 5834-C Swancreek, Toledo, OH 43614

BALL Brothers. Hi-Res 12" TV monitors. New. Great with Apple, TRS80 or Ham-TV. MARIO KLAS, 215 Osceola Ave., Deer Park, NY 11729 (516) 242-2321

BAR graph voltmeter 10 element LED display. Smoked glass front, ready for panel mounting. 3 input ranges, requires 4 to 15-VDC supply. Send \$14.95. FARTHEST FRINGE S.A., 101 Highway Blvd., N. Pekin, IL 61554

PICTURE tube rebuilding equipment— we sell and buy new and used equipment. Free training. ATOL TELEVISION, 6425 Irving Park, Chicago, IL 60634, Phone 312-545-6667

SATELLITE parabolic antenna, including polar mount. Fiberglass and steel construction f/d-.45, 12"-41dB-\$1150.00. SATRONICS COMMUNICATIONS, P.O. Box 2924 Sta. A., Champaign, IL 61820 (217) 398-2873

FM MPX generator ST-1000A with manual and cables. Will ship. \$1000.00. (414) 646-3666. Unit like new.











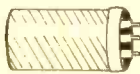

ANALOG delay, audio, and music synthesizer IC's plus more! Free flyer. PGS Electronics, P.O. Box 735B, Terre Haute, IN 47808

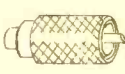
TELEPHONE or office bugged? Latest detection equipment finds out fast. Free literature. CLIFTON, Box 220-M, Miami, FL 33168

MICROWAVE receiver for MDS TV complete and ready to install. 24 db gain; \$250. ALEX, (215) 568-4264

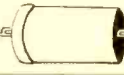
SAVE up to 50% on name brand test equipment. Free catalog and price list. SALEN ELECTRONICS, Box 82-F, Skokie, IL 60077

WRITE FOR
McGEE'S
SPEAKER & ELECTRONICS CATALOG
1001 BARGAINS IN SPEAKERS
Tel.: 1 (816) 642 5092
1901 MCGEE STREET KANSAS CITY, MO. 64108

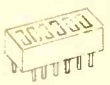
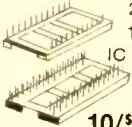
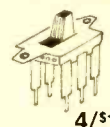
 Burglar Alarm \$5.95	 Capacitor 5200 p 25 v. .49¢	 Signal Meter 0-15 v. .99¢
 Jumbo Leds red diffused 10/\$1.00 100/\$8.00	 Dip Tantalum Caps Dipped 100 @3v. 6.8, 10, 15, 22, 33, 47 @ 6.3v. 22, 68 @ 10v. 1.5, 3, 3.3, 4.7, 6.8 @ 16v. 15 @ 20v. 47, 68, 1.5, 2.2, 3.3, 4.7, 6.8 @ 35v. 22, 68, 1 @ 50v. .25¢	 Led w/min phone plug clear .22¢
 Connector PL259 .60¢	 Connector SO239 .69¢	 BNC Connectors for RG58U or RG590 crimp on .79¢
 Push Button Switch red blue black yellow Normally open .29¢	 Adapter .30¢	 Nicad Battery CS100 CS1.2V 4/\$3.00
 Relay 5v DPDT Aromat \$1.29	 Voice/Noise Actuated Relay .99¢	 Buzzer/Sonar Alert .98¢
 Dipswitch 5 posit .89 6 .99 8 1.09	 Low Profile Dip Sockets 24 and 12 pin IC Sockets .19¢ 10/\$1.00	 Slide Switch 3 PDT PC Mount 4/\$1.00
<p>SEND FOR FREE CATALOG</p> <p>H.J. KNAPP OF FLORIDA INC. 4750 96th St. N., St. Petersburg, Florida 33708</p>		

CIRCLE 29 ON FREE INFORMATION CARD

!SUMMER SURPLUS SELLOUT!

ONE MONTH ONLY! These prices will not be repeated. Buy below cost, help us make room. Prices effective only until Sept 30, '81. All merchandise is new, top quality—Ya gotta see it! Due to the nature of this sale—\$10 minimum order.



4 ft Molded LINE CORD
2 OZ C-1000
15¢



Panel mtd. Air Variable
● DUAL ●
0-50PF, 0-10PF
49¢



10/\$3 1-1/2 LB.
100/\$25 15 LB.
C-2050
5 Conductor white coiled 6' PHONE CORDS
100/\$3.99
10 LB.



6 Volt DC 150mA AC ADAPTER
T-0113 6 OZ
99¢
FITS MOST Portables
ANY QUANTITY



10 WATT CAR STEREO OUTPUT X-FORMER
T-5055 4 OZ
59¢



Transformer
T-6153 9 OZ
6.3v
SMALL SIZE
1.2A
99¢



ROCKER Switches
STANDARD SIZE, SILVER CONTACTS, US MADE
3PDT BLUE ROCKER B-2430
DPDT RED-ILLUMINATED B-2420
10¢ EACH
ANY QUANTITY



Gas Display Transformer
MINIATURE SIZE
10 MA
160 VAC
50 MA
6 OZ 24 VCT
99¢
ANY QUANTITY



\$19
NEW OR LIKE NEW HANDSOME MODERN KEYBOARDS
8 LB. 10/\$160
K-2995
FACTORY SEALED



SLIDE Switches
STANDARD SIZE—SILVER CONTACTS
B-3020 SPST (MOMENTARY)
B-3030 SPDT
B-3130 DPDT
18 LB 1000/\$50
15/\$1 1/2 LB



NE 516 14 pin dip OP-AMPS
DATA SHEET 25 E
10/\$1 2 OZ



40 PIN -GOLD- W/W Socket
S-4040
Augat
ORIGINAL COST \$2.75 EACH AT 5,000!
79¢ 100/\$65
1 OZ 3 LB



PC CARD GUIDES
EXPAND TO ANY WIDTH
2 PAIR
10/\$1
120 PR/\$10
C-1401
24 LB



XFORMER 12V 1A with 3 WIRE CORD & PLUG
1-1201
2 LB
\$2
ANY QUANTITY



ETCHANT AMMONIUM PERSULFATE MIXES WITH WATER FAST & EASY TO USE
1LB/\$1
ONE LB MAKES 2 GAL

DIAMONDBACK ELECTRONICS COMPANY
PO BOX 12095
SARASOTA, FL 33578
PHONE ORDERS 813-953-2829
PLEASE INCLUDE \$1.75 FOR THE FIRST POUND & 25¢ FOR EACH ADDITIONAL LB.
FREE CATALOG

CIRCLE 72 ON FREE INFORMATION CARD

Radio Shack is America's Parts Place™

No Minimum Order! No Waiting! Low Prices!

Printed Circuit Board Template

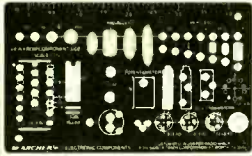

For Fast, Accurate PC Board Designs!

NEW!
3⁹⁵

Superior-quality transparent "cool-blue" stencil with exact-size cut-outs for all commonly used PC components. Simplifies layouts and ends guesswork — your finished boards will have that "pro" look! 276-177 3.95

4" Silicon Solar Cell

NEW!
16⁹⁵

Harness the Sun!

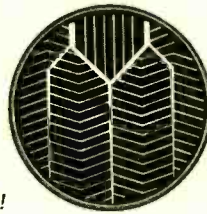

An efficient first-quality cell — use several to power science projects, models, radios, handy-talkies; charge batteries or build into panels, etc. Typical voltage: 0.42. Max. current (short circuit): 2.0A.

276-127 16.95

43-Range, 50,000 Ohms-Per-Volt Multitester With Range Doubler

39⁹⁵

- Big 4 1/4" Mirrored Scale
- Range Doubler Switch Doubles Current and Voltage Ranges



Ready to Use — Not a Kit!

Ideal for home, shop and vehicle electronics testing. Measures: 0 to 1000 volts DC in 12 ranges; 0 to 1000 volts AC in 8 ranges; 0 to 10 amps DC current in 10 ranges; resistance in 5 ranges; Decibels, -20 to +62 in 8 ranges. Features diode-protected movement, function switch with "off" position. Accuracy: ± 3% DC, ± 4% AC. Requires "AA" and 9V batteries. 22-204 39.95

Symbols Template



NEW! **2⁹⁵**

The Easy Way to Draw "Pro-Quality" Schematic Diagrams!

A "must" for electronics students, teachers and designers. This durable see-through stencil has all the most-used component and logic symbols, plus two rules. 276-178 2.95

0 to 15VDC Panel Meter



NEW!
8⁹⁵

Precision D'Arsonval Movement

Ideal for automotive projects, battery chargers, power supplies and more. Accuracy: ± 5%, full scale. 2 3/4 x 2 1/4 x 1 1/4"

270-1754 8.95

16K Dynamic RAM



5⁹⁵
New Low Price!

Was \$13.95 in 1981 Catalog

4116. 100% prime! Access time under 250 ns. Ideal for computer memories.

276-2505 Now 5.95

DPST Reed Relay

Only **99¢**

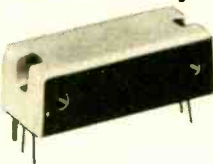

Ideal for low-power circuits. Coil: 12VDC, 375-800 ohms. Contacts: 0.5A @ 125 VAC. PC pins on .100" centers. 1 1/8 x 3/16 x 7/16"

275-229 99¢

100k-Ohm Joystick

NEW! **4⁹⁵**

For Video Games, R/C Vehicles and Microcomputers



Twin linear taper controls with a single, removable 1"-long control shaft. Body: 1 7/16" square. With mtg. screws. 271-1705 4.95

Toggle Switch With LED Indicator

NEW! **2⁹⁹**

Rated 5 Amps



SPST for 12-volt DC — perfect for projects or customizing your vehicle. LED in handle lights in "on" position. 275-680 2.99

5-Pin Inline-Type DIN Socket



NEW! **1⁴⁹**

Designed to accept 3 or 5-pin male DIN-type plugs. Built-in strain relief. Solder terminals. 274-006 1.49

Triac-Output Optocoupler



High Isolation **NEW!** **2¹⁹**

MOC3010. Ideal for a solid-state AC relay or computer control of real-world functions. Switches up to 125VAC at 100 mA. Isolation: 1 kV, minimum. 6-pin. 276-134 2.19

Op-Amp Output Optocoupler



NEW! **2⁹⁹**

1 kV Isolation, Minimum
MOC5010. Ideal for audio projects, audio mixers, more. High linearity. 250 kHz bandwidth. 6-pin. 276-135 2.99

NEW! Ohm's Law "Computer"

49¢
Handy Pocket Guide!



Easy to use — gives you quick answers to Ohm's Law and parallel resistance problems. It'll spoil you! 271-1210 Only 49¢

High-Output Infrared Emitting LED



NEW! **1⁴⁹**

XC880-A. Emits as much energy as three conventional IR LEDs, yet consumes far less current. Good spectral match for photodiodes and transistors. Requires 1.3V at 20 mA. 276-143 1.49

CMOS Timer IC

NEW! **1⁹⁹**



7555. CMOS replacement for 555 timer with very low power consumption (80 µA). 100 mA source or sink. 276-1743 1.99

Phase-Locked Loop

NEW! **1⁵⁹**

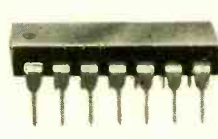

LM565. Basic building block for FM detectors, freq. synthesizers, SCA and RTTY decoders, and more. 14-pin. 276-1720 1.59

Microwave Diodes

NEW! **1⁹⁹**

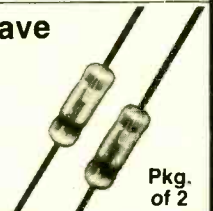

5082-2835. Schottky barrier diodes with low noise figure — ideal for UHF and microwave projects. Why pay more? 276-1124 Pkg. of 2/1.99

NEW 1982 CATALOG AVAILABLE NOW!

Radio Shack

A DIVISION OF TANDY CORPORATION • FORT WORTH, TEXAS 76102
NOW OVER 8000 LOCATIONS WORLDWIDE

CIRCLE 5 ON FREE INFORMATION CARD

7400

SN7400N	19	SN74123N	59
SN7401N	22	SN74125N	39
SN7402N	22	SN74126N	44
SN7403N	22	SN74128N	59
SN7404N	22	SN74132N	69
SN7405N	23	SN74136N	75
SN7406N	23	SN74137N	95
SN7407N	23	SN74141N	79
SN7408N	26	SN74142N	2.95
SN7409N	23	SN74143N	2.95
SN7410N	22	SN74144N	2.95
SN7411N	29	SN74145N	62
SN7412N	29	SN74146N	1.19
SN7413N	39	SN74148N	1.20
SN7414N	59	SN74150N	1.09
SN7416N	29	SN74151N	67
SN7417N	29	SN74152N	67
SN7420N	22	SN74153N	67
SN7421N	35	SN74154N	1.19
SN7422N	29	SN74155N	7.48
SN7423N	29	SN74156N	7.8
SN7425N	29	SN74157N	69
SN7426N	29	SN74158N	1.65
SN7427N	25	SN74160N	88
SN7429N	45	SN74161N	88
SN7430N	23	SN74162N	89
SN7432N	29	SN74163N	87
SN7437N	25	SN74164N	87
SN7438N	29	SN74165N	87
SN7439N	29	SN74166N	1.20
SN7440N	19	SN74167N	1.25
SN7441N	79	SN74170N	1.69
SN7442N	57	SN74172N	4.75
SN7443N	95	SN74173N	79
SN7444N	95	SN74174N	89
SN7445N	79	SN74175N	85
SN7446N	79	SN74176N	75
SN7447N	65	SN74177N	75
SN7448N	79	SN74179N	1.34
SN7450N	19	SN74180N	75
SN7451N	19	SN74181N	1.75
SN7453N	19	SN74182N	75
SN7454N	19	SN74184N	2.25
SN7459N	25	SN74185N	2.25
SN7460N	23	SN74186N	9.95
SN7470N	29	SN74188N	3.90
SN7472N	29	SN74190N	1.15
SN7473N	34	SN74191N	1.15
SN7474N	34	SN74192N	85
SN7475N	38	SN74193N	85
SN7476N	34	SN74194N	85
SN7477N	4.60	SN74195N	68
SN7480N	49	SN74196N	85
SN7481N	95	SN74197N	85
SN7483N	55	SN74198N	1.39
SN7485N	65	SN74199N	1.39
SN7486N	35	SN74221N	1.19
SN7489N	1.75	SN74221N	95
SN7490N	39	SN74273N	1.05
SN7491N	57	SN74279N	1.05
SN7492N	45	SN74283N	1.40
SN7493N	45	SN74284N	3.90
SN7494N	69	SN74285N	3.90
SN7495N	65	SN74290N	1.25
SN7496N	69	SN74298N	95
SN7497N	2.90	SN74299N	88
SN74100N	1.20	SN74366N	68
SN74107N	32	SN74367N	68
SN74109N	37	SN74368N	68
SN74116N	1.95	SN74390N	1.45
SN74121N	39	SN74393N	1.30
SN74122N	39	SN74400N	1.30

74LS00

74LS00N	26	74LS164N	1.19
74LS01N	28	74LS165N	89
74LS02N	28	74LS166N	2.48
74LS03N	28	74LS168N	1.15
74LS04N	35	74LS169N	1.15
74LS05N	28	74LS170N	1.99
74LS06N	28	74LS173N	89
74LS07N	28	74LS174N	89
74LS10N	28	74LS175N	89
74LS11N	39	74LS181N	2.20
74LS12N	33	74LS190N	1.15
74LS13N	47	74LS191N	1.15
74LS14N	95	74LS192N	98
74LS15N	93	74LS193N	98
74LS20N	26	74LS194N	1.15
74LS21N	33	74LS195N	95
74LS22N	33	74LS196N	89
74LS26N	33	74LS197N	89
74LS27N	33	74LS221N	1.15
74LS28N	33	74LS240N	1.69
74LS30N	26	74LS241N	1.69
74LS32N	33	74LS242N	1.69
74LS33N	55	74LS243N	1.69
74LS37N	45	74LS244N	1.49
74LS38N	39	74LS245N	2.20
74LS40N	28	74LS247N	1.10
74LS42N	79	74LS248N	1.10
74LS47N	79	74LS249N	1.10
74LS48N	95	74LS251N	1.49
74LS51N	26	74LS253N	98
74LS54N	29	74LS257N	98
74LS55N	29	74LS258N	98
74LS57N	45	74LS259N	2.95
74LS74N	42	74LS260N	65
74LS75N	59	74LS261N	2.49
74LS76N	45	74LS266N	59
74LS78N	45	74LS273N	1.75
74LS83AN	45	74LS275N	4.40
74LS85N	1.19	74LS279N	59
74LS86N	45	74LS283N	99
74LS90N	57	74LS290N	99
74LS92N	75	74LS293N	99
74LS93N	75	74LS295N	1.10
74LS97N	75	74LS296N	1.10
74LS98N	98	74LS324N	1.75
74LS107N	45	74LS347N	1.95
74LS109N	45	74LS348N	1.95
74LS112N	43	74LS352N	1.19
74LS113N	43	74LS353N	1.19
74LS117N	43	74LS363N	1.49
74LS122N	55	74LS365N	69
74LS123N	1.19	74LS366N	69
74LS124N	1.35	74LS367N	69
74LS125N	89	74LS368N	69
74LS126N	52	74LS373N	1.89
74LS132N	79	74LS374N	1.89
74LS136N	49	74LS375N	69
74LS138N	85	74LS377N	1.95
74LS139N	85	74LS385N	1.95
74LS145N	1.25	74LS386N	65
74LS148N	1.25	74LS390N	1.95
74LS151N	79	74LS393N	1.95
74LS153N	79	74LS395N	1.70
74LS154N	1.70	74LS399N	2.35
74LS155N	1.19	74LS424N	2.95
74LS156N	99	74LS568N	1.75
74LS157N	95	74LS567N	2.29
74LS158N	85	81LS95N	1.69
74LS160N	1.05	81LS96N	1.69
74LS161N	1.15	81LS97N	1.69
74LS162N	1.05	81LS98N	1.69
74LS163N	1.05		

CMOS

CD4000	35	CD4098	2.29
CD4001	35	CD4099	2.25
CD4002	35	MC14408	12.95
CD4006	1.00	MC14409	12.95
CD4007	25	MC14410	12.95
CD4008	1.39	MC14412	12.95
CD4009	45	MC14415	8.95
CD4010	45	MC14419	4.95
CD4011	35	3CS101	1.65
CD4012	45	CD4502	69
CD4013	45	CD4503	69
CD4014	1.39	CD4505	8.95
CD4015	1.15	CD4506	7.5
CD4016	59	CD4507	95
CD4017	1.19	CD4508	68
CD4018	89	CD4511	1.19
CD4019	45	CD4510	1.19
CD4020	1.10	CD4512	1.39
CD4021	1.19	CD4515	2.75
CD4022	1.15	CD4516	1.25
CD4023	39	CD4518	1.39
CD4024	75	CD4520	1.25
CD4025	25	CD4555	4.95
CD4027	65	CD4556	99
CD4028	85	CD4556	2.25
CD4029	1.25	74C01	1.35
CD4030	45	74C02	35
CD4031	3.25	74C04	35
CD4032	2.15	74C08	35
CD4033	3.25	74C10	35
CD4034	3.25	74C14	72
CD4037	1.95	74C20	1.35
CD4040	1.29	74C30	35
CD4041	1.25	74C32	99
CD4042	95	74C42	1.35
CD4043	85	74C48	1.89
CD4044	65	74C73	7.75
CD4046	1.75	74C77	7.75
CD4047	1.25	74C85	1.79
CD4048	99	74C89	5.95
CD4049	45	74C90	1.19
CD4050	69	74C93	1.39
CD4051	1.10	74C95	1.49
CD4052	1.10	74C107	1.19
CD4053	1.10	74C151	2.49
CD4055	3.95	74C154	3.50
CD4056	2.95	74C157	2.10
CD4059	1.25	74C160	1.65
CD4060	1.39	74C161	1.35
CD4066	75	74C163	1.65
CD4069	35	74C164	1.55
CD4070	49	74C173	1.35
CD4071	35	74C174	1.35
CD4072	75	74C175	1.35
CD4073	35	74C192	1.65
CD4075	35	74C193	1.65
CD4076	1.29	74C195	1.55
CD4077	35	74C240	2.19
CD4078	35	74C244	2.19
CD4081	75	74C249	2.19
CD4082	35	74C274	2.39
CD4085	1.95	74C292	5.39
CD4089	2.95	74C923	5.65
CD4093	99	MM80C95	1.50
CD4094	2.95	MM80C97	1.25

RETAIL STORES OPEN NOW-SAT

STORE #1: 1310-B E. Edinger, Santa Ana CA 92705. Showrooms, Retail, Warehouse
 STORE #2: 542 W. Trimbale Road, San Jose, CA 95131 • (408) 946-7010
 RETAIL PRICING MAY VARY

16K UPGRADE ONLY
\$24.95
 SPECIFY COMPUTER

hp HEWLETT PACKARD
 HP-85 \$2695.00
 HP 7225 Graphics Plotter \$1795.00
 HP 16K Memory Module \$265.00
 HP 5 1/4" Dual Master Flex Disk Drive \$2100.00
 HP 5 1/4" Single Master Flex Disk Drive \$1295.00
 HP Personality Module \$40.00
 HP ROM Drawer \$700.00
 HP Plotter/Printer ROM \$130.00
 HP Input/Output ROM \$260.00
 HP Matrix ROM \$130.00
 HP Serial Interface (RS-232C) \$350.00
HP-83 \$1895.00

HP-41: Powerful. Yet Easy to Use
 • The HP-41 communicates with you in words as well as numbers.
 • You can customize the HP-41 to your own design.
 • Programming is fast and easy.
 • Continuous Memory Stores everything.
 • Optional Peripherals allow you to expand capabilities.

HP-41-CV
 HP-41 System II \$398.00
 HP-41C System II \$178.00
 275.00 HP-Card Reader \$105.00
 HP-41C HP-Plotter/Printer \$315.00
 198.00 HP-Quad RAM \$85.00

MINIMOVER-5 ROBOTIC ARM
 Completely Assembled Applications Manual
 • Automation
 • Robotic Assembly
 • Education
 • Robotics Principles
 • Artificial Intelligence Experiments
 • Computer Art and Games

\$1695.00
 Armbasic Software for TRS-80 \$39.95
 w/Applications Manual \$16.95
 Applications/Reference Manual \$16.95

SUPER S-100 BUY!
 • 12 Slot Mainframe
 • 64 Dynamic RAM
 • CP/M™ 2.2
 • Z-80 CPU 4 MHz w/Serial IO
 • Double Density Disk Controller
 • Interface to Vista V-1000 Chassis

SPECIAL PACKAGE PRICE \$1899.00
 FOR COMPLETE SYSTEM
 with (2) Shugart Double Density Floppies mounted. add 1495.00

Proto Clips
 14-Pin Clip PC-14 \$4.25
 18-Pin Clip PC-16 \$4.50
 24-Pin Clip PC-24 \$4.90
 40-Pin Clip PC-40 \$14.95

Proto Boards
 PB-100 16.95 PB-104 \$4.00
 PB-101 21.00 PB-203A \$49.00
 PB-103 43.00 PB-203A-Kit \$129.00

Novation AUTO-CAT™
 Automatic Answer Direct Connect 0-300 Band
 List 279.95
ACP 245.95

CAT™ List 198.00
 Answer Originate **ACP 169.00**

D-CAT™ List 249.00
 direct Connect 0-300 Band. **ACP 189.00**

Single Board Computers
 AIM 65 w/1K 435.00
 AIM 65 w/4K 475.00
 8K BASIC ROM 99.00
 4K ASSEMBLER ROM 84.00
 POWER SUPPLY 64.95
 ENCLOSURE 49.95
 TOTAL SYSTEM w/4K 239.00
SYNERGETIC SYM-1
 SD Z-80 STARTER KIT 367.00
 SD Z-80 STARTER KIT A&T 450.00
 SD SBC 100 Z-80 A&T 399.00
 SD SBC 200 Z-80 A&T 199.00
 RCA COSMAC VPK 449.00
 CROMEMCO Z-80 SBC 449.00

ADVANCED COMPUTER PRODUCTS

apple computer Sales and Service
Apple II® 64K Maxi-System
 • Z-80 Softcard
 • 16K Ram Card
 • Disk II w/controller
 • Apple II w/48K

Call for more pricing!
Total Value \$2719.00 your price \$2229.00
 save! For Pascal System add \$425.00

apple II hardware clearance up to 25% off

VISTA COMPUTER					
Dataview™ Uninterruptible P.S.	395.00	New	Pascal For Above™	29.00	New
VoicePro™ Voice Card	225.00	New	Apple Computer	179.95	
Visior™ 80/80/24 Card	325.00	New	Apple IIe Screen Set I/O	174.95	
Visior 40™ 40 col enhancement	175.00	New	Centronics Printer I/O	299.95	
4 800 Quad Density 8" Controller	695.00	New	Appesoft II Firmware	159.95	
Microsoft Z-80 Softcard	259.00		Apple Clock	244.95	
Microsoft 16K Ramcard	189.00		Apple Graphics Tablet	599.95	
SSM AIO Serial/Parallel I/O	165.00		Apple Prototyping Card	21.95	
CCS Asynchronous 7710 A Serial	139.00		Apple Disk II w/cont. 3.3	558.95	
CCS Parallel Card 7700	155.00		Apple Disk II	456.95	
Apple II "stick" "GDSU"	54.95		Pascal Language Card	125.95	
Mountain Computer	109.00		Parallel Printer Card	459.95	
Romwriter	159.00		Communications Card	189.00	
Introsync I/O	189.00		Integer ROM Card	159.95	
Introsync II Remote Cont. Sys	249.00		Call/Proc Viscasic Keyboard	119.95	
SuperTalker	275.00		M & R Apple Fan	49.95	New
Music System	499.00	New	Corvus 2MB Hard Disk	399.00	New
CPS Multifunction	299.00		Corvus 10MB Hard Disk	Call	
Examination Chassis					

NOW! A 12 HOUR TAPE RECORDER for only \$95.00*

LONG PLAY



High quality AC-DC Cassette Recorder provides 6 continuous hrs. of recording & play back of top quality true fidelity, distortion free sound on each side of cassette for a total of 12 hrs. Built-in features incl. • Voice level control • Auto-tape stop • Digital counter • LED indicator, etc. AC Adapter & TDK DC-180 Cassette incl.

PHONE RECORDING ADAPTER
Model 100CLP

Record incoming and outgoing calls automatically with this all solid state unit connected to your telephone jack and tape recorder. Starts recording when phone is lifted. Stops when you hang up. **\$24.50*** FCC APPROV.

VOX VOICE ACTIVATED CONTROL SWITCH
Adjustable sensitivity. Voices or other sounds automatically activate and order or remote mike. **\$24.95***

*Add for ship. & hdg. Phone Call Adapter & VOX Recorder \$4.00. Cal. Res. add tax. Mail order, VISA, M/C, cod's ok. Qty. disc. avail. Money back guar. Free data. Dir. inq. inv. **AMC SALES, Dept. 19, 9335 Lubec St., Box 928, Downey, CA (213) 90421 Phone 869-8519**

CIRCLE 25 ON FREE INFORMATION CARD

FOTO-SLAVE TRIGGER KIT

PROBABLY THE MOST SENSITIVE SLAVE TRIGGER KIT ON THE MARKET. NOT AFFECTED BY AMBIENT LIGHT. MUCH SUPERIOR THAN LASER TYPES. THIS KIT CAN OPERATE FROM BOUNCE OR INDIRECT FLASH. KIT INCLUDES ALL PARTS, CIRCUIT BOARD AND STAY COORD FOR CONNECTION TO STRIBE. SIZE: 1.5" x 1". **C4450 \$6.00**

WHEEL OF FORTUNE KIT

Popular game device uses LEDs, transistors, and IC to give the effect of a bright red ball spinning around numbers. Unit emits sound as ball spins and finally stops on a number. Incl. all parts, faceplate & PC board. **C3806 \$9.99**

SEQUENTIAL LED FLASHER KIT

IC CIRCUITRY SEQUENTIALLY LIGHTS UP 10 RED LEDs CONTINUOUSLY. WITH ALL PARTS AND PC BOARD. SIZE: 5.25" x 1.5". REQUIRES 9V BATTERY. **C4431 \$6.75**

FASCINATION STAR KIT

PRODUCES AN "EXPLODING STAR" VISUAL EFFECT. USES 25 LEDs AND IC CIRCUITRY. GREAT ATTENTION GETTER FOR DISCOS, ETC. WITH ALL PARTS AND PC BOARD. SIZE: 5.2" x 3.1". REQUIRES 9V BATTERY. **C4432 \$10.95**

SOUND EFFECTS KIT

COMPACT KIT USES THE POPULAR I176477 CHIP TO CREATE PHASOR, LOGMOTIVE, SIREN, BIRDS, ETC SOUNDS. WITH ALL PARTS, PC BOARD AND SPEAKER. SIZE: 3.25" x 4". REQUIRES 9V BATTERY. **KIT C4422 \$12.95**
ASSEMBLED C4423 \$15.95

GREEN NEONS

SAVE AS MUCH EXCEPT GLOWING BRIGHT GREEN. OPERATES ON 120VAC. C4351 \$3.00 R FOR \$7.00

PHOTOFLASH CAPS

350PF 330V C2702 \$.75
720PF 360V C2930 \$1.25

SOLAR POWER SALE

2.95 GIANT 3" WHOLE CELL C4448 OUTPUT .4V AT 100MA

SPECIAL 9V 30MA BATTERY REPLACEMENT PANEL FOR POWERING TRANSISTOR RADIO. CALCULATOR. C4396 **\$12.00**

LARGER SOLAR PANELS

6V 125MA \$25.00 C4409
12V 125MA \$49.00 C4410
12V 250MA \$89.00 C4411
12V 500MA \$150.00 C4412

120 VAC Xenon Strobe Kit

Complete variable rate strobe light kit. Comes with all parts. PC board. Includes complete instructions. **C23071 \$7.50**

KHANNEY electronics inc.
P.O. BOX 27038 • DENVER, COLORADO 80227

Phone Orders 303-781-5750 • Minimum AD Order \$6.00
• Please include \$1.50 for postage
• VISA MC accepted
• Phone orders are welcome

Send for our free catalog of unique items

CIRCLE 27 ON FREE INFORMATION CARD

FUJITECH AUDIO KITS

LATEST AUDIO TECHNOLOGY FROM JAPAN

- Model A501 Power Amp**
- Pure Class A 25W + 25W
 - Switchable to Class AB 100W + 100W
 - Switchable to Bridge Class A 100W mono
 - Switchable to Bridge Class AB 300W mono
 - Frequency Response 5-200KHz (-1dB)
 - Signal-to-Noise Ratio 120dB
 - Non-magnetic Chassis
 - "Out-board" comprehensive protection circuitry
 - DC circuitry with limited use of NFB
 - High Efficiency Fluid Convection Cooling
 - THD under 0.007%

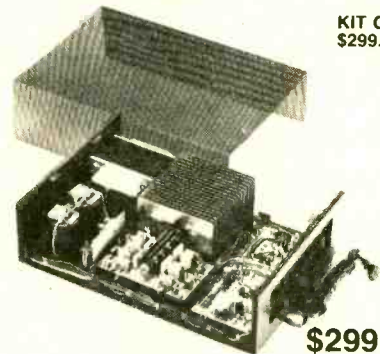

KIT ONLY \$299.00

\$299.00

Model A502 DC Stereo Control Center

- Direct DC coupling from Input to Output
- DC servo circuitry
- Cascade FED Input in all stages
- Separate Moving Coil RIAA amplifier
- Distortion below 0.005% (3V)
- Max Output 15V
- Frequency Response 20Hz-20KHz ±0.2 dB
- Maximum Phono Input
MC = 16mv RMS (1KHz)
MM = 270mv RMS (1KHz)
- Built-in Headphone amplifier
- Relay Output Muting

KIT ONLY \$349.00



\$349.00

Model A1033 Integrated Tube Amplifier

- Latest Japanese Design
- Distortionless Output Transformer using special winding techniques
- Most circuitry on PCB for easy assembly and humfree performance
- Output 30W x 2 Ultra Linear (Switchable to Triode)
15W x 2 Triode Output (near class A performance)
- THD under 0.4%
- Frequency Response 30~30,000 Hz (-1dB)
- Separate Pre-Out and Main-In

KIT ONLY \$499.00

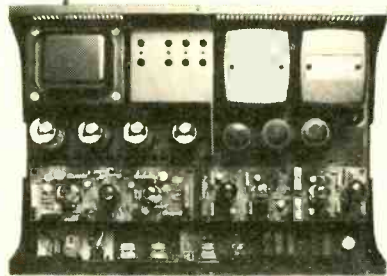

\$499.00

Send \$5.00 for each assembly manual, refundable with order.

Monarchy Engineering, Inc.
380 Swift Avenue, Unit 21
South San Francisco, CA 94080
Visa or Mastercharge acceptable.

THIS IS THE PLACE FOR PARTS.

memory EXPANSION: 16K DYNAMIC RAMS NOW ONLY \$19.95!!

These top quality, low power, high speed parts expand memory in TRS-80* I/II/III and Color Computers, Heath H89, Apple, newer PETs, etc. Backed by one year limited warranty. Add \$3 for two dip shunts and conversion instructions for TRS-80* I.

*TRS-80 is a trademark of the Tandy Corporation

Why pay more... we stock the right parts at the right price.

SOLDERTAIL SOCKETS AT A GREAT PRICE

8 pin 100/\$5.95 20 pin 40/\$4.95
14, 16 - 18 pin 50/\$4.95 24, 28 pin 30/\$4.95
40 pin 20/\$4.95

POWER SUPPLIES

12 VOLT 8 AMP: \$44.50. With crowbar overvoltage protection, current limiting, adjustable output 11-14V. RF suppression, easy assembly. Does not include enclosure and line cord. Allow \$10 for shipping; excess refunded.

1/2 AMP POWER SUPPLY: \$8.00 (specify 5, 6, 8, or 12 Volt operation). Regulated, short-proof, thermally limited, 1 A intermittent operation. Less case and hardware.

BIPOLAR SUPPLY #13-XX: \$15.00 (specify ±5V, ±6V, ±8V, ±9V, ±12V, or ±15V operation). Regulated, very simple assembly, virtually blow-out proof, delivers ±250 mA minimum per side.

**SPECIAL! EPROMS AT A GREAT PRICE:
2708 EPROM \$3.50 EACH; 2716 EPROM \$8.50 EACH. LIMITED QUANTITY.**

FREE CATALOGUE: Find out more about our exceptional product line. For 1st class delivery, add 52 cents in stamps; foreign orders add \$2 (refundable with order).

CIRCLE 53 ON FREE INFORMATION CARD

CMOS ICs

4012-S	Dual 4 input NAND	12/\$2
4020-S	14 stage counter	4/\$2
4023-S	Triple 3 input NAND	12/\$2
4044-S	Quad R-S latch	4/\$2
4046-S	Phase locked loop	2/\$2
4071-S	Quad 2 input OR	12/\$2
4093-S	Quad 2 in NAND Schmitt trig	4/\$2
4507-S	Quad EX-OR	4/\$2
4510-S	BCD up/down counter	2/\$2
4511-S	BCD to 7 seg decode/drvr	3/\$2
4512-S	8 channel data selector	4/\$2
5101-S	CMOS 1K low power memory	10/\$17.50

TO-220 NEG VOLT REGULATORS

7906	-6V regulator	2/\$2
7908	-8V regulator	2/\$2
7912	-12V regulator	2/\$2
79M15	-15V regulator	2/\$2
7918	-18V regulator	2/\$2
7924	-24V regulator	2/\$2

MISCELLANEOUS SPECIALS

1000 uF 35V axial capacitor	10/\$2.00
10,000 uF 10V axial capacitor	5/\$2.00
S-100 card edge connectors	10/\$29.50
Resistor asst. (cut & bent leads)	1000/\$5
RCA phono jacks - these are super quality, closed circuit jacks that are the best we've seen in years. American made.	20/\$1.95
2102 low power 1K static RAM	10/\$9.90
General purpose silicon signal diodes	50/\$2
GT5306 NPN darlington, min gain 17000, 25V 200 mA, TO92 package	100/\$8.95
NPN transistor similar 2N3904	100/\$7.95
PNP transistor similar 2N3906	100/\$8.95
4N28 opto-coupler 6 pin minidip, MCT-2/IL-1 pinout	5/\$2
SN76477 complex sound generator	1/\$2.50
Low price! MA1003 12V DC clock module: \$10.95, matching case \$3.95.	

TERMS: Cal res add tax. Allow 5% shipping; excess refunded. Orders under \$15 add \$2 handling. VISA® and Mastercard® orders (\$25 minimum) call (415) 562-0636, 24 hrs. include street address for UPS. Prices subject to change without notice; limited quantity on most items.

GODBOUT

ELECTRONICS

BOX 2355, OAKLAND AIRPORT, CA 94614

SURPLUS ELECTRONICS CORP.

7294 N.W. 54th Street
Miami, Florida 33166

WHOLESALE/RETAIL

EQUIPMENT/COMPONENTS/WIRE & CABLE/ACCESSORIES

Phone: (305) 887-8228
TWX: 810-848-6085
We accept MasterCard and Visa.

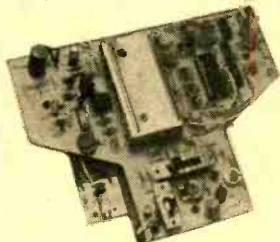

"TANK BATTLE" TV GAME

In just a short time and with a few minor parts, the most novice hobbyist can complete this exciting Tank Battle game. Create a fun-filled evening for the whole family. Two independent tanks rumble thru land mine fields, shoot shells and fragment when hit. Four distinct engine sounds are produced for the different speeds. Sounds of gunfire, shell bursts and tank explosions are realistic. Automatic on-screen scoring. Supplied with schematic drawing.

SOLD AS IS
\$9.95 ea.



C.B. SPECIAL

CONVERT THESE TO 10 METER FM

New printed circuit board assembly. (Squelch pot, volume control and channel switch not included.) Boards sold as is, the way we bought them from the manufacturer. Board dimensions 6" x 6 1/2"

1-9 **\$7.50**
100-UP **\$5.50**

COPPER CLAD BOARD

(Double Side)
Size 9.25 x 10.75
Thickness .062
\$2.00 ea.

PANEL METERS

25-0-25 VDC, 2 1/4" x 3"
0-25 VDC, 2 1/4" x 2 1/4"
0-50 VAC, 2 1/4" x 2 1/4"
(Shunt required)
\$4.00 ea 2/\$7.00

E. F. JOHNSON S METER



Edge Meter 250 UA,
fits in 3/8" x 1 3/8" hole.
Black background.
Scale 1-20 Top,
0-5 Bottom.

\$1.25 ea. 5/\$5.00

COMPUTER GRADE ELECTROLYTICS

VALUE/MFD	VOLTS	DIAM./LGTH.	PRICE
63,000	@ 15V	3" x 5 1/2"	\$4.00 ea.
10,000	@ 20V	1 1/2" x 5 3/4"	\$3.00 ea.
2,700	@ 25V	1 1/4" x 2 1/4"	\$2.00 ea.
2,900	@ 25V	1 1/4" x 2"	\$2.00 ea.
3,000	@ 25V	1 1/2" x 4 1/2"	\$2.00 ea.
100,000	@ 30V	3" x 5 1/2"	\$6.00 ea.
39,000	@ 30V	1" x 5 3/4"	\$4.00 ea.
34,800	@ 50V	3" x 5 1/2"	\$3.00 ea.
450	@ 75V	1 1/4" x 2 1/4"	\$2.00 ea.
500	@ 100V	1 1/2" x 3 1/4"	\$2.00 ea.
240	@ 300V	1 1/4" x 3 1/4"	\$2.00 ea.
50	@ 450V	1 1/4" x 2"	\$2.00 ea.

DIP SWITCH



7 POSITION **\$1.30 ea.**
8 POSITION **\$1.50 ea.**
12 POSITION **\$2.00 ea.**

TRIMMER CAP



1.5-20pF (ARCO PC-402)
50¢ ea.

AMP METERS

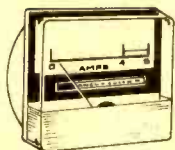

2 1/4" square, no shunt required.
Easy to read dial.
Movement: 0-6, 0-10, 0-17
\$2.50 ea.

SUB-MINI 10K POT

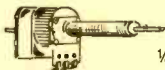

5/\$1.00

with On-Off
1/4" hole mount,
1/8" D shaft,
3/4" thread section.

ASTATIC T-UG8-D104 MICROPHONE

Pre-amp desk-top microphone with crystal element 3-pin plug.

\$35.00 ea.

E.F. JOHNSON SIGNAL STRENGTH METER

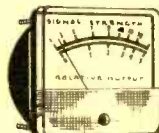

\$4.95 ea.

200 UA, 2 1/2" x 2 1/2" Sq.
Scale: 1-30 db top (orange),
0-50 bottom (black)

9 VOLT NiCd RECHARGEABLE BATTERY

NEW. Replaces the popular 9V Transistor Battery.



\$4.75 ea.

MUFFIN FANS



MFG By Rotron Inc.
3 Blades 4 3/4" Square
USED
110 VAC **\$5.95 ea.**
NEW
230 VAC Model MU3A1
\$12.00 ea.

SPEAKER

3" Diam.,
8 OHM,
5 Watts.

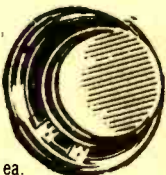

\$2.00 ea.

SPEAKER



Weather & water-proof
(can be used underwater),
mfg. by University Sound,
16 OHM, 25 Watt,
350-10,000 HZ.
6" diam. x 5" deep.
Model #MM-2
\$25.00 ea.

AXIAL LEAD ELECTROLYTIC CAPACITORS

2 uF @ 15V	12/\$1.00
10 uF @ 15V	12/\$1.00
20 uF @ 15V	12/\$1.00
50 uF @ 15V	12/\$1.00
2.2 uF @ 25V	12/\$1.00
3.3 uF @ 25V	12/\$1.00
1 uF @ 35V	12/\$1.00
2 uF @ 150V	12/\$1.00
25 uF @ 25V	15/\$2.00
3 uF @ 50V	15/\$2.00
5 uF @ 50V	15/\$2.00
10 uF @ 50V	15/\$2.00
250 uF @ 25V	10/\$2.00
100 uF @ 50V	10/\$2.00
50 uF @ 75V	10/\$2.00

4 5/8" w x 7 3/8" l x 3/4" to 1 1/2" h
Has a lip for recessed face plate and a felt bottom

IC SOCKETS GOLD-PLATED WIRE WRAP

14 pin **40¢ ea.**
16 pin **45¢ ea.**
24 pin **75¢ ea.**
40 pin **\$1.75 ea.**



NEW SPRITE FAN

Mfg. by Rotron Inc.,
Model SU2A5.
115v AC. 19 amps.
(Impedance protected.)
3 1/4" x 3 1/4" x 1 1/4"
\$12.00 ea.

COAX CONNECTORS

UG-273/U BNC-F/UHF-M **\$2.50**
UG-255/U BNC-M/UHF-F **\$3.00**
UG-146 A/U N-M/UHF-F **\$4.50**
UG-83B/U N-F/UHF-M **\$4.50**
UG-175 RG-58 Adapt **\$.20**
UG-176 RG-59 Adapt **\$.20**
UG-1094 BNC-F/Panel **\$1.00**

SO239 **50¢**
PL259 **60¢**

COAXIAL CABLE

50 OHM-RG 174
\$4.95/100' \$3.00/50'
75 OHM-RG 62/U
\$12.00/100'

C & K SWITCHES

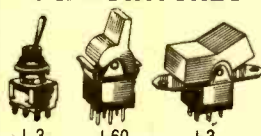

Part #	Movement
J-60 7101	SPDT
J-60 7103	SPDT (center off)
L-3 7108	SPDT (momentary)
J-3 7201	DPDT (special large rocker)

\$1.00 ea. 6/\$5.00

D.P. CABLE ASSEMBLIES



Conn & Hood	22 AWG # Cond	Length
25 P	14	15'
25 S	10	17'

MAGNETIC CHESS BOARD WITH MEN

Folds in half to carry men
11" w x 11" l x 1 1/4"
\$4.00 ea.

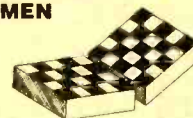

TERMS: All material guaranteed unless otherwise stated. If you are not satisfied with our product, it may be returned within 10 days for a refund (less shipping). Please add \$4.00 for shipping and handling on all orders. COD's accepted for orders totaling \$50 or more. All orders shipped UPS unless otherwise specified. Florida residents please add 4% sales tax. Minimum order, \$15.00. Foreign orders - US funds only, add 20% for shipping and handling.

ok PRODUCTS



JUST WRAP KIT

Just Wrap tool for daisy chain wiring. Tool strips as it wraps and cuts. Includes one 50 foot spool of wire.

Part No.	Description	Price
JW-1*	Just Wrap Tool	\$14.95
JWK-6	Tool w/4 Spools and JUW1	24.95
R-JW*	50 Ft. Replacement Wire	3.49
JUW-1	Unwrapping Tool	3.49

*Specify Color: Red, Blue, White or Yellow.



Regular Wrap



Modified Wrap

HAND WRAP TOOL

Part No.	Description	Price
WSU30	Regular	\$6.95
WSU30M	Modified	7.95

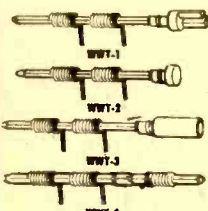

TERMINALS

- .025 (0,63mm) Square Post
- 3 Level Wire-Wrapping
- Gold Plated
- 25 PER PKG.

Part No.	Description	Price
WWT-1	Slotted Terminal	\$4.98
WWT-2	Single Sided Terminal	2.98
WWT-3	IC Socket Term.	4.98
WWT-4	Double Sided Terminal	1.98
INS 1	Insertion Tool for above	2.49

SOCKET WRAP - ID

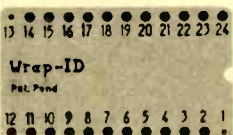

Slipped onto socket before wrapping to identify pins.

Part #	Price	Bulk Price	Part #	Price	Bulk Price
14ID	1.49/10	5.50/100	22ID	1.49/5	5.95/50
16ID	1.49/10	5.95/100	24ID	1.49/5	5.95/50
18ID	1.49/10	5.00/50	28ID	1.49/5	6.50/50
20ID	1.49/5	5.00/50	40ID	1.49/5	5.00/25



P.C.B. TERMINAL STRIPS

The TS strips provide positive screw activated clamping action, accommodate wire sizes 14-30 AWG (1,8-0,25mm). Pins are solder plated copper, .042 inch (1mm) diameter, on .200 inch (5mm) centers.

Part No.	Description	Price
TS- 4	4-Pole	\$1.69
TS- 8	8-Pole	2.59
TS-12	12-Pole	3.49
TS6MD	2-Pole Interlocking	3/1.79



DESOLDERING PUMP

Easy one hand operation.

Rugged all metal construction. Replaceable TEFLON® Tip. Self cleaning on each stroke.

Suction precisely regulated for reliable desoldering without damage to delicate circuitry.

Part No.	Description	Price
DSPI	Desoldering Pump	\$9.95

LOGIC PROBE



Compatible with all logic families using a 4 to 15V power supply. Thresholds automatically programmed. Visual indication of logic levels to show high, low, bad level or open circuit logic pulses.

- 10 N sec. pulse responses
- 120 K input impedance.
- Automatic resetting memory.
- Includes tip with protective cap & coiled cord.

Part No.	Price
PRB-1	\$36.95

LOGIC PULSER

Superimposes a pulse train (20 pps) or a single pulse onto the circuit node under test without un-soldering IC's.

- Automatic polarity sensing
- 2 us pulse width
- Finger tip push button actuated
- Includes tip with protective cap & coiled cord.

Part No.	Price
PSL-1	\$48.95

VACUUM VISE

Unique vacuum-based light duty vise for precision handling of small components and assemblies. Rugged ABS construction. 1½" (32mm) travel for maximum versatility. Also features screw lugs for permanent installation.



Part No.	Description	Price
VV1	Vacuum Vise	\$3.49



HOBBY-WRAP TOOL BW2630

- Auto-Indexing
- Anti-Overwrap
- Modified Wrap

Part No.	Description	Price
BW2630	Tool	\$19.85
BT30	#30 Bit (not incl.)	3.95
BT2628	#28 Bit (not incl.)	7.95
BC1	Batteries & Charger	14.95

INSERTION/EXTRACTION TOOLS

Part No.	Description	Price
INS1416	14-16 pin Inserter	\$3.49
MOS1416	14-16 pin MOS Safe Inserter	7.95
MOS2428	24-28 pin MOS Safe Inserter	7.95
MOS40	40 pin MOS Safe Inserter	7.95
EX1	14-16 pin IC Extractor	1.49
EX2	24-40 pin IC Extractor	7.95



WK-7 IC INSERTION KIT

Complete IC Inserter/ Extractor Kit Individual Components (listed above) \$22.95

IC DISPENSER

Allows IC's to be dispensed from their tube 1 at a time and picked up by insertion tools above.

- Dispenses 8-42 pin IC's • Compatible with all IC carrying tubes • Use with WK7 for MOS safe insertion. •

Part No.	Description	Price
MDD1	1 Chan. Dispenser	\$21.85
MDD5	5 Chan. Dispenser	83.43
MDD10	10 Chan. Dispenser	160.45

* * *No Discount.

TOLL FREE ORDERING NUMBER 1-(800) 423-7144

IDC CONNECTORS



RIGHT ANGLE HEADERS

Size	SOLDER TAIL		WIRE WRAP	
	Part No.	Price	Part No.	Price
10	IDH10SRB	\$1.20	IDH10WRB	\$2.60
20	IDH20SRB	1.90	IDH20WRB	4.15
26	IDH26SRB	2.75	IDH26WRB	5.35
34	IDH34SRB	3.75	IDH34WRB	6.25
40	IDH40SRB	3.75	IDH40WRB	7.35
50	IDH50SRB	4.75	IDH50WRB	9.20

.1" Spacing. Mounts on PC Board & Mates with IDS Socket below. Ejector Bars - 4/1.00.



EDGE CARD CONNECTORS

Size	Part No.	Price
10	IDE10B	\$3.95
20	IDE20B	4.35
26	IDE26B	5.00
34	IDE34B	6.05
40	IDE40B	6.90
50	IDE50B	7.50

.1" Spacing. Crimps onto cable with ordinary vise & mates with standard .062" Card Edge.

RIBBON CABLE

Size	Solid Color		Color Coded	
	10 ft.	100 ft.	10 ft.	100 ft.
10	2.90	17.00	4.00	30.00
14	3.40	23.80	5.00	42.00
16	3.70	27.20	5.60	48.00
20	4.40	34.00	7.00	60.00
24	5.00	40.80	8.00	72.00
26	5.40	44.20	8.60	78.00
34	6.80	57.80	11.00	102.00
40	7.80	68.00	13.00	120.00
50	9.50	85.00	16.00	150.00



25 PIN "D" CONNECTORS

Solder Style	Part No.	Price
Male	DB25P	\$2.95
Female	DB25S	3.95
Cover	DB25C	1.50

IDC Style	Part No.	Price
Male	IDB25P	6.25
Female	IDB25S	6.60
Cover	IDB25C	1.60

Solder Style solders onto cable, IDC Style crimps onto cable with vise. 9, 15, 37 and 50 pin available also.



CABLE PLUGS

Size	Part No.	Price
14	IDP14B	\$1.45
16	IDP16B	1.65
24	IDP24B	2.50
40	IDP40B	4.15

.1" Spacing. Crimps onto cable with ordinary vise & plugs into standard IC Socket.



SOCKETS

Size	Part No.	Price
10	IDS10B	\$1.88
20	IDS20B	2.75
26	IDS26B	3.50
34	IDS34B	4.50
40	IDS40B	5.40
50	IDS50B	6.50

.1" Spacing. Crimps onto cable with ordinary vise & mounts to header sold above.

WIRE WRAP SUPPLIES

WIRE WRAP WIRE

Length	#30 Wire Wrap Wire		
	100/Bag	500/Bag	1K/Bag
2.5"	\$1.38	\$3.94	\$6.81
3.0"	1.43	4.25	7.46
3.5"	1.51	4.57	8.11
4.0"	1.56	4.88	8.73
4.5"	1.63	5.21	9.39
5.0"	1.69	5.54	10.04
5.5"	1.74	5.92	10.69
6.0"	1.82	6.23	11.34
6.5"	2.11	7.08	12.99
7.0"	2.19	7.44	13.68
7.5"	2.29	7.78	14.40
8.0"	2.35	8.12	15.10
8.5"	2.40	8.46	15.80
9.0"	2.46	8.92	16.51
9.5"	2.53	9.15	17.22
10.0"	2.63	9.58	17.91

All lengths are overall, including 1" strip on each end. Choose from colors; Red, Blue, Black, Yellow, White, Green, Orange, and Violet.

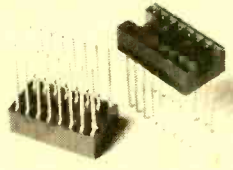

Size	Part No.	Each	Tube
08	ICN083WBSG	.44	52x .39 = \$20.28
14	ICN143WBSG	.53	30x .46 = \$13.80
16	ICN163WBSG	.58	26x .50 = \$13.00
18	ICN183WBSG	.78	23x .68 = \$15.64
20	ICN203WBSG	1.00	21x .85 = \$17.85
22	ICN224WBSG	1.07	19x .92 = \$17.48
24	ICN246WBSG	1.09	17x1.09 = \$15.98
28	ICN286WBSG	1.43	15x1.23 = \$18.45
40	ICN406WBSG	1.85	10x1.60 = \$16.00

Selective Plating provides gold in contact where it counts. 3-level wrap. Save by buying sockets by the tube. All gold available at 1/2¢/pin extra charge.

* * * No Discount

WIRE KITS

Kit No. 1 - \$9.95			
250	3"	100	4 1/2"
200	3 1/2"	100	5"
100	4"	100	6"
Kit No. 2 - \$24.95			
250	2 1/2"	250	5"
500	3"	100	5 1/2"
500	3 1/2"	100	6"
500	4"	100	6 1/2"
250	4 1/2"	100	7"
Kit No. 3 - \$34.95			
250	2 1/2"	500	4 1/2"
500	3"	500	5"
500	3 1/2"	500	5 1/2"
500	4"	500	6"
Kit No. 4 - \$59.95			
500	2 1/2"	1000	4 1/2"
1000	3"	1000	5"
1000	3 1/2"	1000	5 1/2"
1000	4"	1000	6"

ORDERING INFORMATION

Prepaid orders over \$50 shipped prepaid via UPS. All others add \$3.00 for handling. VISA, MC, COD's and open account orders will be charged freight, \$15 minimum order. \$100 minimum open account order.

DISCOUNT SCHEDULE

Order Amount	Net
\$15 - 99	less 10%
100 - 199	less 15%
200 - 499	less 20%
500 - 999	less 25%
1000 up	

Discount and the name of this magazine must be mentioned at time of order to get discount. Discount applies on all items except as noted, "No Discount."

CIRCLE 54 ON FREE INFORMATION CARD

SCOPE SALE

OUR LOWEST PRICES
OF THE YEAR!



Single and dual trace, 15 thru 100 MHz. All high sensitivity Hitachi oscilloscopes are built to demanding Hitachi quality standards and are backed by a 2-year warranty. They're able to measure signals as low as 1mV/division (with X5 vertical magnifier). It's a specification you won't find on any other 15 or 30 MHz scopes. Plus: Z-axis modulation, trace rotation, front panel X-Y operation for all scope models, and X10 sweep magnification. And, 30 thru 100 MHz oscilloscopes offer internal signal delay lines. For ease of operation, functionally-related controls are grouped into three blocks on the color coded front panel. Now here's the clincher: For what you'd expect to pay more, you actually pay less. Check our scopes before you decide. All scopes complete with probes.

Hitachi...The measure of quality.
HITV302B

30MHZ DUAL TRACE OSCILLOSCOPE
List \$995.00
SALE \$819.00

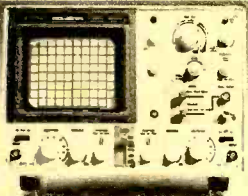

- TV sync-separator circuit
- High-sensitivity 1mV/div (5MHz)
- Sweep-time magnifier (10 times)
- Z-axis input (intensity modulation)
- Signal delay line
- Complete with 2 probes
- CH1, CH2, DUAL, ADD, DIFF, Vertical Deflection Modes
- X-Y operation
- Trace Rotation

HITV152B DUAL TRACE 15MHZ (no delay)
LIST \$735.00 **SALE \$629.00**



HIT-V202
20MHZ DUAL TRACE

LIST PRICE: \$850
SALE PRICE **CALL**

- Dynamic range 8 div.
- TV sync-separator circuit
- Built-in signal delay line (V-352)
- X-Y operation
- Sweep-time magnifier (10 times)
- Trace rotation system
- Fine-adjusting, click-positioning function

HIT-V352
35MHZ DUAL TRACE WITH DELAY

LIST PRICE: \$1150.00
SALE PRICE **CALL**

- Economically priced dual trace oscilloscope
- Square CRT with internal graticule (illuminated scale)
- High-accuracy voltage axis & time axis set at $\pm 3\%$ (certified at 10° to 35°C)
- High-sensitivity 1mV/div.
- Low drift
- 2 Year Warranty

50MHz & 100 MHz
DUAL TRACE WITH
CALIBRATED TIME DELAY

HIT V550B
50MHz with
3rd TRACE

TRIGGER VIEW
LIST \$1745.00
SALE

CALL

HIT V1050
100MHz with
3rd & 4th TRACE

TRIGGER VIEW
LIST \$2390.00
SALE

CALL

The HITACHI V550B (50MHz) and V1050 (100MHz) offer all the capabilities you might expect from a lab grade oscilloscope. Capabilities such as 3rd trace trigger view, a bright 6" square CRT, and a max. sweep rate of 2ns/div (V1050) 5ns/div (V550B). Also, features you may not expect like, sensitivity of 1mV/div (V550B) 5mV/div (V1050) @ 10MHz, automatic focus correction.



APPLE II MODEM

SYNCHRONOUS SERIAL INTERFACE
THE ULTIMATE IN DATA COMMUNICATIONS
FOR THE APPLE II

The new CAT for Apple by Novation is a complete data communications system for the Apple II computer. It consists of a single card LSI modem that offers automatic dialing, answer and disconnect functions plus fully selectable operation from 110 to 1200 baud including the BAUDOT code for the Deaf Network.

- 300/1200 Baud, LSI Dual Speed, Direct connect Modem with receiver sensitivity greater than -40dBm
- Auto answer/auto pulse 7 touch tone dialing/auto disconnect
- Single Unit card with pluggable firmware
- Software selectable communication speeds compatible with Bell 103 (300 Baud) or Bell 202 (1200 Baud)
- FCC approved for direct connect to phone network-no external coupler required
- Full/Half duplex at 300 Baud or Half duplex at 1200 Baud
- Modem plugs into Apple Bus (No external units)
- Easy to use operating programs supplied on Disc
- Separate RS232 3-wire port for operating Printer/Terminal at 110 to 1200 Baud
- Power supplied to Apple (minimum load)
- Optional handset provides full telephone capability
- Optional program ROM's for pascal and CPM
- Optional Tape input for recording incoming voice messages

	List Price	Our Price
NOV-APLCAT	\$389.00	\$359
NOV-490403	Expansion Module	39
NOV-490404	Handset	29
NOV-490405	BSR Control*	19
NOV-490406	Cassette Rec. Cable*	5
NOV-490407	Touch Tone Receiver	99
NOV-490408	Firmware	29
NOV-490409	Deaf Firmware	29
NOV-490410	Software Diskette	29

*Requires expansion module



Vector

S-100 COMPATIBLE PLUGBOARDS FOR INTERFACE,
MEMORY EXPANSION, EXPERIMENTATION

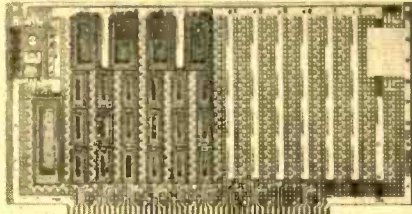

VCT- 8800V

Universal Microcomputer/processor
plugboard, use with S-100 bus. Complete
with heat sink & Hardware. 5.3" x 10" x 1/16"

1-4	5-9	10-24
\$22.48	\$20.37	\$18.26

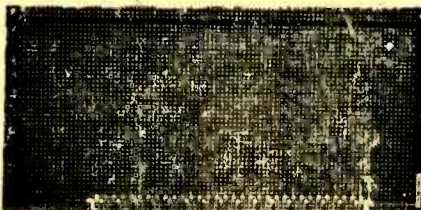

VCT- 8801-1

Plain no etched circuitry except contacts.
Produces maximum flexibility.

1-4	5-9	10-24
\$15.67	\$14.24	\$12.82

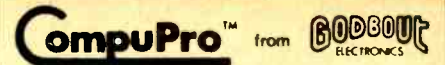

ANOTHER FAMOUS
PRIORITY 1 ELECTRONICS
TRUCK LOAD PURCHASE

10 MHZ 16K A&T
STATIC S-100 RAM

GBT-143A
List \$349.00

\$169.00 Ea
3/\$450.00

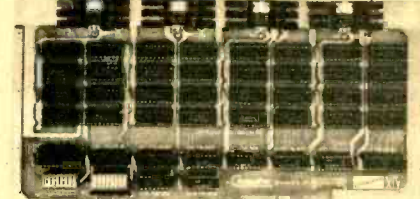

- Operates up to 10 MHz (90 ns RAM Chips)
- Assembled & Tested
- Meets or exceeds all IEEE 696/S-100 specifications (Including timing).
- Fully static design eliminates the timing problems associated with dynamic memories.
- Switch selectable choice of 24 address lines conforming to the IEEE 696/S-100 extended addressing specifications, or 16 address lines as used in older S-100 systems.
- Ideal for multi-user installations.
- Board is addressable as one 16K x 8 block on any 4K boundary.
- Switch selectable PHANTOM disable and write protect.
- +5 Volt operation (requires no other supply voltages).
- Low power operation (900 mA typical, 1200 mA maximum).
- 1 year Factory Warranty.



California Computer Systems LIST \$425.00

CCS2422A
FLOPPY DISK CONTROLLER **SALE**
WITH CP/M VERSION 2.2 **\$375.00**

IEEE S-100 COMPATIBLE SINGLE/DOUBLE DENSITY
5 1/4" DISK DRIVES
SINGLE/DOUBLE HEADED
ASSEMBLED & TESTED

CCS2810 Z80 CPU
2/4 MHZ CPU W/Serial I/O

CCS2810 A&T List Price \$310.00 SALE PRICE \$275.00

Shugart
SA801R
SALE

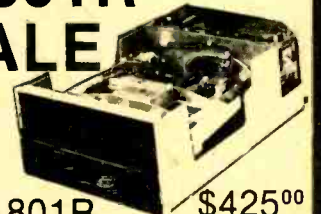

SHU-SA801R \$425.00
2 OR MORE **\$410.00 ea.**

PRIORITY ONE ELECTRONICS

9161-R DEERING AVE. • CHATSWORTH, CA 91311



Terms: U.S., VISA, MC, BAC, Check, Money Order, U.S. Funds Only. CA, residents add 6% Sales Tax. MINIMUM PREPAID ORDER \$15.00. Include MINIMUM SHIPPING & HANDLING of \$2.50 for the first 3 lbs., plus 25¢ for each additional pound. Orders over 50 lbs. sent freight collect. Just in case...please include your phone no. Prices subject to change without notice. We will do our best to maintain prices thru AUGUST, 1981. SOCKET and CONNECTOR prices based on GOLD, not exceeding \$700.00 per oz.

Sales Prices are for prepaid orders only. Credit Card orders will be charged appropriate freight.



DETACH OUR CATALOG FROM THE MAY BYTE

DETACH OUR CATALOG FROM THE MAY BYTE

MODEM SALE

\$129.00



**THE STAR
MODEM
from
LIVERMORE**

**FEATURE
FITS GTE HANDSETS!
2 YEAR WARRANTY**

EXCLUSIVE ACOUSTIC CHAMBERS

The exclusive triple seal of Livermore's new flat mounted cups locks the handset into the acoustic chamber yielding superior acoustic isolation and mechanical cushioning. Designed to adapt to most common handsets used throughout the world, the STAR offers the utmost in flexibility and transmission reliability.

Specifications:

- Data Rate: 0 to 300 baud
- Compatibility: Bell 103 and 113, CCITT
- Frequency Stability: ±0.3 percent, Crystal controlled
- Receiver Sensitivity: -50 dBm ON, -53 dBm OFF
- Modulation: Frequency shift keyed (FSK)
- Carrier Detect Delay: 1.2 seconds ON, 120 msec OFF
- EIA Terminal Interface: Compatible with RS 232 specifications
- Teletype Interface: 20 millampere current loop
- Optional Interfaces: IEEE 488, TTL, TTY 43
- International (CCITT) frequencies available
- Switches: Originate/Off/Answer, Full Duplex/Test/Half Duplex
- Indicators: Transmit Data, Receive Data, Carrier Ready, Test
- Power: Supplied by 24 VAC/150 MA UL/CSA listed wall-mount transformer. Input 115 VAC, 2.5 watts (A 220 VAC, 50 Hz adaptor is available upon request.)
- Dimensions: 10" x 4" x 2"
- Weight: 1.74 lbs (3 lbs. shipping weight including AC adaptor)
- Warranty: Two years on parts and labor, excluding the AC adaptor which carries the manufacturer's warranty



Part No.	Description	List Price	SALE PRICE
LIV-STAR	RS232, TTL, 20 MA Current Loop	\$199.00	\$129.00

CABLES

Part No.	Description	Price
CND-RS2328F	RS232 8 Cond 8 ft	\$19.95

RS232 and "D" SUB-MINIATURE CONNECTORS

P = Plug, Male Type - S = Socket, Female Type - C = Cover, Hood

PART NO.	DESCRIPTION	PRICE		
		1-9	10-24	25-99
CND-DE9P	9 PIN MALE	\$ 2.10	\$ 1.90	\$ 1.70
CND-DE9S	9 PIN FEMALE	\$ 2.70	\$ 2.40	\$ 2.10
CND-DE9C	9 PIN COVER	\$ 1.50	\$ 1.25	\$ 1.10
CND-DA15P	15 PIN MALE	\$ 2.75	\$ 2.45	\$ 2.15
CND-DA15S	15 PIN FEMALE	\$ 3.95	\$ 3.60	\$ 3.20
CND-DA15C	15 PIN COVER	\$ 1.50	\$ 1.30	\$ 1.10
CND-DB25P	25 PIN MALE	\$ 3.00	\$ 2.75	\$ 2.60
CND-DB25S	25 PIN FEMALE	\$ 4.00	\$ 3.75	\$ 3.50
CND-DB25C	25 PIN COVER	\$ 1.60	\$ 1.45	\$ 1.30
CND-P25H	2 PC. GREY HOOD	\$ 1.50	\$ 1.25	\$ 1.10
CND-DB51226	2 PC. BLACK HOOD	\$ 1.90	\$ 1.65	\$ 1.45
CND-DC37P	37 PIN MALE	\$ 5.80	\$ 5.10	\$ 4.45
CND-DC37S	37 PIN FEMALE	\$ 6.70	\$ 7.70	\$ 6.70
CND-DC37C	37 PIN COVER	\$ 1.80	\$ 1.55	\$ 1.30
CND-DD50P	50 PIN MALE	\$ 8.75	\$ 7.75	\$ 6.70
CND-DD50S	50 PIN FEMALE	\$ 11.65	\$ 10.25	\$ 8.90
CND-DD50C	50 PIN COVER	\$ 2.00	\$ 1.80	\$ 1.60
CND-D20418	HARDWARE SET 2 PR. RS232, DB25P, EIA	\$ 1.00	\$ 0.80	\$ 0.70
CND-RS2328F	CLASS 1 CABLE 8 COND, 8 FT.	\$19.95	\$17.95	\$15.95
CND-5730360	CENT 700 SERIES PRINTER CONNECTOR	\$ 9.00	\$ 7.50	\$ 6.00

GOLD S-100 CONNECTORS

Part No.	1-9	10-24	25-99	100-249
\$100 STG	3.50	3.20	2.80	2.50
WIRE WRAP PRICE				
Part No.	1-9	10-24	25-99	100-249
\$100 WWG	4.00	3.75	3.50	3.25

PRIORITY ONE ELECTRONICS

9161-R DEERING AVE. • CHATSWORTH, CA 91311

Terms: U.S., VISA, MC, BAC, Check, Money Order, U.S. Funds Only, CA. residents add 6% Sales Tax. MINIMUM PREPAID ORDER \$15.00. Include MINIMUM SHIPPING & HANDLING of \$2.50 for the first 3 lbs., plus 25¢ for each additional pound. Orders over 50 lbs. sent freight collect. Just in case... please include your phone no. Prices subject to change without notice. We will do our best to maintain prices thru AUGUST, 1981. SOCKET and CONNECTOR prices based on GOLD, not exceeding \$700.00 per oz. Sales Prices are for prepaid orders only. Credit Card orders will be charged appropriate freight.

2708

450ns 8K EPROM

\$8.50 EA.

8/\$32.00

2716

450ns 5 Volt only 16 K EPROM

\$11.95 EA

8/\$48.00

2114-3L

4096 BIT (1024x4) 300ns LOW POWER STATIC RAM

8/\$30⁰⁰

100 + \$3⁰⁰

2016P3

2K x 8 200ns L/P STATIC RAM

8/\$100⁰⁰

TRS-80/APPLE MEMORY EXPANSION KITS

4116's RAMS
from Leading Manufacturers

100% GUARANTEED (16Kx1 200ns) SETS SOLD 1,000's

8 for \$24⁰⁰

ADD \$3.00 FOR PROGRAMMING JUMPERS FOR TRS-80 KEYBOARD

4116's 100 pcs & UP \$2.75 each

1000 pcs & UP \$2.50 each

POWERLINE INSULATOR

GOF-IBARW3

SH. WT. 3 LBS.

LIST PRICE **\$59⁹⁵**

SALE PRICE **\$29⁹⁵**

A MUST FOR EVERY OFFICE WITH DATA PROCESSING EQUIPMENT

PROTECT YOUR INVESTMENT
PROTECT YOUR DATA WITH

ISOBAR

GOF-IBAR46

- Inductively Isolated grounds
- Sockets individually filter isolated
- Each socket isolated from power line

LIST PRICE **\$79⁹⁵**

SALE PRICE **\$39⁹⁵**

6 OUTLET MULTI USE CORD REEL

THE CONVENIENCE OF AN EXTENSION CORD AND POWER DISTRIBUTION PANEL IN ONE COMPACT, SELF-STORING UNIT!

- SIX GROUNDED 3-PRONG OUTLETS!
- CIRCUIT BREAKER FOR SAFETY'S SAKE - GUARDS AGAINST OVERLOADS ABOVE 10 AMPS

GOF-CR21 22 Ft. - 5 lbs. \$24.95
GOF-CR50 50 ft. - 10 lbs. \$39.95

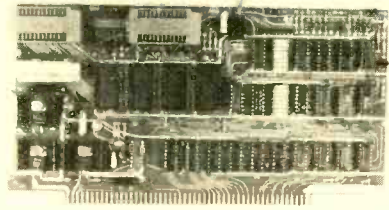

PB1 2708/2716 PROGRAMMER & 4K/8K EPROM BOARD

PB1 has two separate programming circuits so 2708 or 2716 (5v) type of EPROMs can be programmed without modifying the board. Programming voltage is generated on-board, no need for an external power supply. Programming sockets are Dip Switch addressable to any 4K boundary. And complete software is provided for programming and verifying EPROMs.

Unused EPROM sockets don't take memory space, so you are never committed to the full 4K or 8K of memory.

SSMPB1K	Kit	List Price	Our Price
SSMPB1A	Assembled & Tested	\$265.00	\$179.00
			\$230.00



5 1/4" DISKETTES

Part No.	Sectoring	Application	# of heads	Box/10
VRB-MD525-D1	Soft Sector	TRS-80 Apple		
		40 Track Cert	1	\$32.00
VRB-MD525-10	Hard 10 Sector	North Star		
		40 Track Cert.	1	\$32.00
VRB-MD525-16	Hard 16 Sector	Micropolis		
		40 Track Cert.	1	\$32.00
VRB-MD557-01	Soft Sector	100TPI	2	\$56.00
VRB-MD557-10	Hard 10 Sector	77 Track Cert	2	\$56.00
VRB-MD557-16	Hard 16 Sector	100 TPI	2	\$56.00
VRB-MD577-01	Soft Sector	77 Track-Cert	2	\$56.00
VRB-MD577-10	Hard 10 Sector	100 TPI	1	\$48.00
VRB-MD577-16	Hard 16 Sector	77 Track Cert.	1	\$48.00
		100 TPI	1	\$48.00

VRBMD Series comes with reinforced hub ring mounted.

8" DISKETTES

VRB-FD32	Hard Sector	Shugart 801R	1	\$37.00
VRB-FD34	Soft Sector	IBM 3740	1	\$37.00
VRB-FD32-2	Hard Sector	Flippy	1	\$66.00
VRB-FD34-2	Soft Sector	Flippy	1	\$66.00

Verbatim 8" Diskettes have all the Datalife improvements without the hardhole reinforcement rings. ALL VERBATIM DISKETTES ARE DOUBLE DENSITY CERTIFIED

SPECIAL PURCHASE

GOLD
16 PIN LOW PROFILE I.C.
C-95 SOCKETS

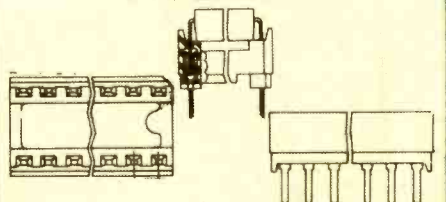

TIG-16LP pkg. of 100 **\$16⁰⁰**

TIG-16LP pkg. of 1,000 **\$120⁰⁰**

OEMS Stock up at this LOW PRICE

DETACH OUR CATALOG FROM THE MAY BYTE

DETACH OUR CATALOG FROM THE MAY BYTE



DENNY SALE

Buy 1 Jumbo Pak for \$2.99
and get the 2nd for
One Penny.

Order today by calling us
on our new toll-free number.
800-343-3086

For orders only.

- 400-PRE-FORMED 1/2 WATTERS, popular values, some 5 & 10%ers, (#6246)
- 35-UPRIGHT ELECTROS, 100%, assorted values & voltages, marked (#3226)
- 75-CABLE TIES, 4" non-slip white plastic, like Ty-wrap, (#5218)
- 50-MINI POTS, pc style, single turn, assorted values (#3345)
- 150-PC CAPACITOR SPECIAL, asst. mylars, polys, micas, etc. 100% mat. (#6264)
- 175-1/2 WATT RESISTORS, asst. carbons, carbo-films, some 5%ers. (#5797A)
- 60-POLYSTYRENE CAPS, assorted types, styles & sizes, all good. (#2729)
- SURPRISE PAK Assortment of IC's, caps, pots and parts of every desc. (#6648)
- 175-HALF WATTERS, 100% color coded resistors, asst. values. (#3046)
- 175-MOLEX SOCKETS, "on a strip", make your own pc sockets. (#6255)
- 400-PRE-FORMED 1/4 WATTERS, assorted values, neg. coefficient, 100% (#6622)
- 24-MINI-BULBS, ASST. VOLTAGES & base styles, precut for PC appl. (#6757)
- 125-LONG LEAD DISK, prime, marked caps, assorted material. (#2598)
- 50-SLIDE SWITCHES, various shapes, sizes and types (#2726)
- 25-MICRO MINI REED SWITCHES, 1" long, for alarms, relay systems, etc. (#6263)
- 50-THERMISTORS, various types & styles, neg. coefficient, 100% (#4089)
- 200-PRE-FORMED DISCS, caps w/leads for PC use, mixed values, (#2605)
- 50-AXIAL ELECTROS, asst. values, volts, sizes, what a buy! (#3227)
- 100-PLESSY CAPS, ceramic blocks in assorted sizes & values, (#6221)
- 3-WATCH GUTS, 5-function, LED style, assorted sizes, untested (#6287)
- 6-TIME DELAYS, solid state, asst. from 450 mSec to 8 Sec. (#6758)
- 100-POWER TRANSISTORS, untested, to-92, asst. types (#2604)
- 75-TRANSISTOR ELECTROLYTICS, epoxy encapsulated, asst. values, (#2747)
- 20-SLIDE VOLUME CONTROLS, various values & types, for Hi-Fi, etc. (#3057)
- 500-PC-HARDWARE SURPRISE, (approx.) 1 lb. asst. screws, washers, etc. (#6271)
- 100-POWER RESISTORS, 3 to 7 watt power resistors, (#6281)
- 50-2 WATT RESISTORS, assorted carbons, films etc. some 5%ers, (#6238)
- 24-SKINNY TRIM POTS, multi & single turn, asst. values & types, (#6285)
- 40 CRYSTALS, assorted types, some H6/U, some frequency marked. (#6256)
- 20-9V BATTERY CLIPS, snap connector, coded, insulated leads, (#6286)
- 4 HEAVY DUTY LINE CORDS, 2 cond. 6ft., 16 gauge (#6292)
- 200-PRECISION RESISTORS, 1/2 W, assorted wattages 1%, axial (#2428)
- 30-PANEL SWITCHES, assorted rotary, micro, slide, etc. (#6629)
- 20-PAIRS-RCA PLUGS & JACKS, popular for Hi-Fi, speakers, etc. (#6630)
- 4-2N3055 NPN TRANSISTORS, 115 watts, 15 amps, TO-3, 100% mat. (#6633)
- 5-LINE CORDS, heavy-duty, 18 gauge, 6', molded plug, 2-cond. (#6499)
- 20-2N3055 HOBBY TRANSISTORS, manu. fallout, TO-3, U-test, (#6624)
- 25-PLASTIC POWERS, 25 watt, npn & pnp, 50-200 vcbto, TO-220. (#6237)
- 150-"4000" RECTIFIERS, IN4000 series, may include; 50 to 1000V (#2417)
- 30-SCRs & TRIACS, assorted values, 10 Amp TO-220, untested. (#6337)
- 60-IN914 SWITCHING DIODES, 4 nsec, axial, glass, untested. (#6632)
- 30-INSTRUMENT KNOBS, for half round shafts, some w/pointers (#6498)
- 35-STEREO INDICATORS, tiny red 1.5V bulbs, for Hi-Fi replacement. (#6244)
- 40-EDGE CONNECTORS, asst. 4 & 6 pin, 2-slided, pc leads (#6364)
- 6-MINI-MOTORS, type RE56, 1.5-6VDC, color-coded wire leads. (#6718)
- 25-NE-2 BULBS, neon, for 110 VAC, requires resistor, (not incl.) (#2613)
- 150-METALLIC RESISTORS, mostly 1/2 watters, asst. val. 1-5% tol. (#6280)
- 40-VOLUME CONTROLS, assorted values & types (#6331)
- 25-2N3904 TRANSISTORS, 100% material (#6370)
- 20ft. COLORED 20 MIL FIBERS, 2' lengths, assorted colors. (#6768)
- 125-ONE WATT RESISTORS, top names, mostly carbons, some 5%ers (#3300)
- 200 PC SEMICON SPECIAL, asst. diodes, zeners, etc. untested. (#6284)
- 40-STRAIN RELIEFS, asst. types in various sizes & shapes (#6756)
- 1-UHF TUNER, 3-gang, 300 ohm, direct drive type (#6658)
- 200-TUBULAR CAPS, asst. tubulars, 100mmf to 0.1mf to 600 WVDC (#6254)
- 60-MINI LAMP SOCKETS, asst. screw, bayonet, & snap-in's (#6789)
- 150-SUBMINI TRANSFORMERS, asst. transistor radio types (#6259)
- 10-PUSHBUTTON ALARM SWITCHES, asst n.c. 1A 125 VAC (#6267)
- 25-DATA ENTRY SWITCHES, asst. 1/2" square keyboard switches (#6667)
- 10-MOTORS MOTORS, asst. size hobby motors, 1-1/2 to 12 volts. (#2551A)
- 150-TERMINAL STRIPS, asst. screw & solder lug types. (#6251)
- 50-TO-5 TRIACS, asst. 50 to 600 IV, 70% yield, gold plated, 3 leads (#6321)
- 200-HI-QUALITY RESISTORS, 1/8, 1/2, & 1 watters. 1% & 5% (#6627)
- 40-MYLAR UPRIGHT CAPS, asst. epoxy, plastic, polystyrene, etc. (#6634)
- 20-HOBBY LEDS, asst. types styles & colors, mostly dims. (#6225)
- 12 FT.-FIBER OPTIC RIBBON, 3/8" wide ribbons conduct light (#6770)
- 100-PIN SOCKETS, inline male & female crimp-on connectors (#6902)
- 100-ASSORTED SPACERS, nylon spacers, washers, grommets, etc. (#6617)

"JOIN THE PAK"
DON'T MISS OUR 25th
ANNIVERSARY CATALOG



P.O. BOX 942, RE-9
S. LYNNFIELD, MA. 01940

Total Amount of Order \$ _____

INCLUDE SHIPPING AND HANDLING: U.S., ADD \$3.; FOREIGN, ADD \$7.
MASS. RES. ADD 5% SALES TAX.

NAME _____

ADDRESS _____

CITY _____

STATE _____ ZIP _____

Enclosed is CHECK, MONEY ORDER
Charge my MASTERCARD VISA

ACCT. # _____ EXP. DATE _____

Orders only 800-343-3086 Other calls 1-617-245-3828

ORDERING INSTRUCTIONS • Indicate quantity on line or box near item
desired • Complete coupon section • Cut out Ad and mail to Poly Paks, Inc.

■ Send me your FREE catalog

CIRCLE 42 ON FREE INFORMATION CARD

- 4K X 16 MEMORY board with 64 IC chips (2101) in sockets. Complete board with data. Super deal 50.00
- 4116-4 MEMORY 16K \$2 each or 8 for . . . 14.00
- MK 8164 MEMORY 64K Dynamic Ram 25.00
- MPI 8 inch single side disc drive (OK, used) 175.00
- MPI 8 inch dual sided disc drive (OK, used) 350.00
- SHUGART 8 inch drive 850 FDD (ok, used) 425.00
- MOTOROLA MONITOR 9 inch 115 volt 60.00
- MOTOROLA MONITOR 12 inch 115 volt 85.00

Above 2 units accept composite video, no case, used.
2 units below accept TTL. Hi volt supply only. Used.
BALL BROS. 12 inch monitor 50.00
BALL BROS. 5 inch monitor, cased, used. 60.00

DATA STATION CONSOLE w/keyboard & 9 inch monitor, power supply. Logic boards broken send for details on this one. \$ 80.00

- IR SCOPE see in the dark, new, portable. 260.00
- IR SCOPE KIT pre-assembled, modular 150.00
- 12 VOLT GEL CELL 2 1/2 AH \$14.00 5 AH 17.00
- 12 inch CRT bonded face plate, new, with specs. Made for computer work. \$25 each 5 for \$100.00
- UNDERWATER HYDROPHONE 200 KC 10.00

WALKY TALKIES Govt surplus used condition. 47-55.4 mc range. With schematics. Govt AN/PRC-6 \$25 each 2 for \$45. Ant. \$5 each
ASCII KEYBOARD parallel \$50
RED LED's 10 for \$1.00



MIN ORDER \$10.00 CATALOG No. 20 now ready

Shipping extra on all merchandise

Meshna Inc., PO Box 62, E. Lynn, Mass. 01904

CIRCLE 23 ON FREE INFORMATION CARD

SURPLUS BUYS of the YEAR!!

The Most Sought After. Most Desirable

DIABLO 10 MEG DISK DRIVES

- 5 Mb Fixed. 5 Mb Removable
- 115 VAC 60 Hz
- Takes 5440 Disk
- Industry Std. Drive
- Daisy Chain up to 4
- I/O Data Included
- Built-in Power Supplies
- 200 Tracks / Inch
- 256 Bytes per Sector
- 24 Sectors / Track
- 19,583 Sectors / Platter



REFURBISHED & OPERATIONAL Now Only \$1995.00 each Includes 2 FREE DISK CARTRIDGES

- MODEL 44A DISK DRIVE 10 Mb. Earlier design, same I/O. Used whole, untested includes schematics and data \$1200.00
- MODEL 43 5 MEG DISK DRIVE 100 TPI. good cond., used whole. untested. With data and schematics \$795.00
- MODEL 429 POWER SUPPLY ±24VDC @ 6 amps. 5V @ 6 amps Required for both the 44A and 43 drives (above) \$750.00

MORE BARGAINS

* SELECTRIC-II Typewriter/Printer

With stepper-driven platen & carrier. Existing possibilities. Removed from sophisticated word processors. Solenoids (standard selectric corresp code) self contained. Mostly whole. "as-is" with schematics and data. Only \$349.00

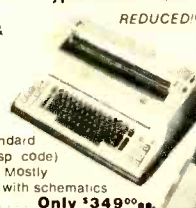

RO*SELECTRIC-II PRINTER

"Receive-only" (no keyboard). Features X&Y steppers plus all solenoids & standard IBM Selectric-II printer mechanism. Takes Tech-III ribbon cartridges. Less case and platen, mostly whole. "as-is" Schematics included. Only \$129.00

Disk Drives Add \$30 for Hdig & Pkg. Pay Shipping on Delivery. Selectric Printers Add \$20 Hdig & Pkg. Pay Shipping on Delivery. *Reg. Trade Mark of IBM Corp.

Formerly CFR Associates Inc.
NEW NUMBER
COMPUTERS, PERIPHERALS, 617/372-8637
UNLIMITED!
18 GRANITE STREET
HAVERHILL, MASS. 01830
MasterCharge & VISA Accepted

CIRCLE 10 ON FREE INFORMATION CARD

THANDAR INSTRUMENTS

ORDER ANY TWO INSTRUMENTS & TAKE A 3% DISCOUNT



SC 110



PDM 35



TF 200 & TP 600



TG 100

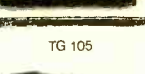

TG 105



TM 353



TM 354

- 3 1/2 Digit LED Multimeter
DM 235 \$ 69.95
- 3 1/2 Digit LED Multimeter
DM 350 99.95
- 3 1/2 Digit LED Multimeter
PDM 35 39.95
- 8 Digit LED Hand Held Freq Meter
PFM 200 99.95
- Single Trace Portable Oscilloscope
SC 110 259.00
- 8 Digit LCD Frequency Meter
TF 040 199.00
- 8 Digit LCD Hand Held Freq Meter
TF 200 299.00
- 100 KHz Function Generator
TG 100 159.00
- 2 MHz Function Generator
TG 102 299.00
- 5 MHz Pulse Generator
TG 105 199.00
- 3 1/2 Digit LCD Bench Multimeter
TM 351 199.00
- 3 1/2 Digit LCD Bench Multimeter
TM 353 159.00
- 3 1/2 Digit LCD Hand Held Multimeter
TM 354 79.00
- 600 MHz Prescaler
TP 600 79.00

Intersil LED or LCD 3 1/2 DIGIT PANEL METER KITS

BUILD A WORKING DPM IN 1/2 HOUR WITH THESE COMPLETE EVALUATION KITS
Test these new parts for yourself with Intersil's low cost prototyping kits, complete with A/D converter and LCD display (7106) or LED display (7107). Kits provide all materials, incl PC board, for a functioning panel meter.
IC17106EV (LCD) \$14.45 IC17107EV (LED) \$28.70



8 Digit - 10 MHz Universal Counter Kit

- Kit Includes:**
- ICM7226A/DC IC
 - 10 MHz Quartz Crystal
 - (8) 7 Segment 3" LED Displays
 - PC Board
 - Resistors
 - Capacitors
 - Diodes
 - Switches
 - IC Socket
- Order Part Number ICM7226AEV \$74.95

* MICROPROCESSOR CRYSTALS *

FREQ (MHz)	CASE	PIN	PRICE	FREQ (MHz)	CASE	PIN	PRICE	FREQ (MHz)	CASE	PIN	PRICE
1.00	HC23	CY14	\$9.50	4.5562	HC18	CY8A	\$8.00	18.00	HC18	CY15A	14.75
1.8432	HC33	CY14	5.50	5.00	HC18	CY7A	8.00	18.00	HC18	CY19A	4.75
2.00	HC33	CY2A	8.25	5.068	HC18	CY5B	8.00	18.432	HC18	CY19B	4.75
2.4576	HC33	CY2B	8.25	5.7143	HC18	CY5C	5.00	19.800	HC18	CY20A	8.00
3.2768	HC33	CY3B	6.00	6.00	HC18	CY6B	8.00	20.00	HC18	CY22A	5.25
3.576	HC33	CY3B	6.00	6.144	HC18	CY6C	8.00	23.888	HC18	CY23B	5.25
4.00	HC18	CY1A	6.00	8.00	HC18	CY9C	9.00	27.00	HC18	CY27A	8.15
4.434	HC18	CY4C	6.00	10.00	HC18	CY12A	4.75	32.00	HC18	CY32A	8.15
4.85	HC18	CY4B	6.00	14.31818	HC18	CY14A	4.75	100.00	HC18	CY100A	8.15

ANCRONA

STORES DO NOT ACCEPT MAIL ORDERS

MAIL ORDER

P.O. BOX 2208R CULVER CITY, CA 90230

PHONE ORDERS (213) 641-4064

Minimum Order \$10.00. Add \$2.00 to cover shipping and handling. Master Charge and VISA welcomed. Please include your charge card number, inter-bank number and exp. date. Some items are subject to prior sale. Not responsible for typos. Store pricing may vary from Mail Order. We reserve the right to substitute manufacturer.

Flasher LED

Red LED and Flasher IC Chip in One Package

FRL-4403 ONLY

92¢ ea.

KTM-2 CRT/TV Kybd Tarm 5349

MARK IV LED POWER LEVEL INDICATOR

70 pins KIT \$31.50

- Display Range -36dB to +5dB
- Floating or Gradual Output Indicating
- Kit includes transistors, leds, capacitors, resistors, PC Board, and silk screened metal front panel

SYM-1

\$239.00

ATLANTA
3330 Piedmont Rd. N.E.
Atlanta, GA 30305
(404) 261-7100

CULVER CITY
11080 Jefferson Blvd.
Culver City, CA 90230
(213) 390-3595

HOUSTON
2649 Richmond
Houston, TX 77098
(713) 529-3489

PORTLAND
1125 N.E. 82nd Ave.
Portland, OR 97220
(503) 254-5541

SANTA ANA
1300 E. Edinger Ave.
Santa Ana, CA 92705
(714) 547-8424

SUNNYVALE
1054 E. El Camino Real
Sunnyvale, CA 94087
(408) 243-4121

TUCSON
4518 E. Broadway
Tucson, AZ 85711
(602) 881-2348

commodore VIC-20

Introducing the full featured, expandable color computer \$299.95

SILICON GENERAL

Linear IC and Voltage Regulator Databook
214 pages \$4.50

30 MHz HITACHI

DUAL TRACE PORTABLE OSCILLOSCOPE

MODEL V-302B \$995.00

More sensitive to your input

Z-80 SERIES		6800 SERIES		MC6800P		P6505A	
Z-80-CPU	\$ 8.95	MC6800P	\$ 5.90	MC6886P	10.80	P6505A	10.70
Z-80-CTC	6.50	MC6801L1	65.84	MC6882P	11.80	P6506	9.70
Z-80-P10	6.50	MC6802P	11.50	MC6881P	6.90	P6506A	10.70
Z-80-DART	15.45	MC6805U2P2	30.72	MC6882A1	3.14	P6507	9.70
Z-80-DART-9	13.50	MC6809P	13.90	MC6885P	6.13	P6512	9.70
Z80-S10/D	24.40	MC6821P	3.48	MC6886P	2.72	P6512A	\$16.60
Z80-S10/A	18.20	MC6828P	9.90	MC6887P	2.72	P6513	9.70
Z80-S10/2	20.10	MC6840P	12.22	MC6888P	2.72	P6513A	10.70
		MC6843P	45.39	MC6889P	3.14	P6514	9.70
		MC6844P	45.39			P6515	9.70
		MC6845P	22.00	6502 SERIES		P6515A	10.70
		MC6846P1	39.90	P6502	\$ 6.40	P6520	5.90
		MC6846P3	66.50	P6502A1(2MHz)	7.90	P6520A	6.20
		MC6847P	16.06	P6503	9.70	P6521A	6.80
		MC6850A	3.40	P6503A	10.70	P6522	6.40
		MC6852P	3.50	P6504	9.30	P6522A	11.90
		MC6854P	32.26	P6504A	10.70	P6532	7.80
		MC6859L	277.90	P6505	9.30	P6532A	10.20

MINIATURE DOT MATRIX IMPACT PRINTER

MODEL DP-822

The Unique New Printer That Gives You All These Exciting Features.

- Low Cost
- Disposable printing head
- Simple interface
- Handles any type font
- Needs only one 12-volt DC power supply
- Uses standard 2 1/4" adding machine tape or carbonless paper
- 21-column printing at 25 lines per second
- Easy to install and maintain

Model DP-822 \$70.00
Dot Matrix Printer Control/Drive Card Model DP-822-08B \$125.00

HAMEG

10 Megahertz

HM307 SINGLE TRACE OSCILLOSCOPE

Only \$435.00

- IDEAL SERVICE INSTRUMENT
- TIME BASE 0.2 μs - 2.0 s/cm
- LPS-TRIGGER ■ COMPACT
- BUILT-IN COMPONENT TESTER

	1-9	10 up	100 up
2114 (200ns)	\$3.45	\$2.85	\$2.45
2114L3	3.90	3.20	3.00
4116 (200ns)	3.50	2.85	2.55
2708	5.90	5.30	5.00
2716 (5V)	6.50	5.50	4.50
2732 (350ns)	18.90	16.90	15.90

8080A-8085A and Support IC's		Z8000 SERIES		RS232 CONNECTORS	
8080A	\$5.00	Z8001 DC	\$150.00	DB25P male	2.95
8080B	10.00	Z8002 DC	140.00	DB25F female	3.60
8080C	4.50	Z8003 DC	99.00	SEED	1.75
8080D	2.10	Z8004 DC	4.90	H00T	7.50
8080E	3.10	Z8005 DC	4.90		
8080F	2.40	Z8006 DC	4.90		
8080G	5.80	Z8007 DC	5.60		
8080H	22.00	Z8008 DC	3.65		
8080I	6.00	Z8009 DC	19.60		
8080J	13.00	Z8010 DC	2.50		
8080K	6.40	Z8011 DC	5.20		
8080L	6.10	Z8012 DC	3.00		
8080M	11.90	Z8013 DC	3.60		
8080N	15.90	Z8014 DC	3.00		
8080O	3.90	Z8015 DC	24.40		
8080P	3.90	Z8016 DC	7.65		
8080Q	3.90	Z8017 DC	2.10		

ANCRONA HAS MOTOROLA IC's

8FR90	\$1.89	MC1309P	\$2.86	MC1458CL	\$1.44	MC4016P	8.52
8FR91	2.42	MC1310P	2.88	MC1458CP1	6.18	MC4024P	5.75
CA305A	1.54	MC1330ATP	1.60	MC1458P1	1.17	MC4026P	3.48
CA3059	3.34	MC1349P	1.72	MC1458P1S	1.26	MC4044P	5.75
CA3079	2.23	MC1350P	1.15	MC1469G	4.24	MC4316L	16.72
MBD101	73	MC1361P	2.10	MC1469H	7.89	MC4558NCP1	3.18
MBD102	28	MC1362P	2.01	MC1469L	7.65	MC4558NCP1	2.50
MBD201	1.03	MC1365P	2.10	MC1489AL	1.48	MC8919P	2.73
MBD501	1.57	MC1357P	1.55	MC1489L	1.48	MC10104P	9.2
MC663P	3.20	MC1358P	1.50	MC1489S	1.39	MC10109L	1.24
MC664P	3.20	MC1364P	2.01	MC1494L	6.04	MC10118L	1.24
MC665P	1.91	MC1372P	6.48	MC1495L	5.28	MC10116P	3.02
MC667P	3.70	MC1375P	5.19	MC1496G	1.80	MC10123L	2.39
MC668P	1.91	MC1391P	1.44	MC1804L	2.27	MC10124L	3.91
MC677P	2.05	MC1403AP	3.78	MC1808P	1.36	MC10125L	2.50
MC678P	2.05	MC1403AU	11.07	MC1809P	1.36	MC10131P	3.04
MC680P	2.05	MC1403UDS	4.23	MC1810P	1.36	MC10137L	25.38
MC684P	5.10	MC1405L	15.28	MC1469H	8.26	MC10159P	4.14
MC830L	2.27	MC1406L	2.94	MC1300L	3.09	MC10189L	3.23
MC832L	2.27	MC1408L7	4.75	MC1302P	5.88	MC10195L	2.52
MC835L	2.46	MC1408L8	4.64	MC1303P	9.80	MC10198P	22.51
MC836P	1.50	MC1408P8	4.40	MC1325P	2.10	MC10216L	1.88
MC837P	1.50	MC1413P	1.33	MC1340P	2.10	MC10231P	5.81
MC839L	5.86	MC1436CU	7.99	MC1495L	5.28	MC12040P	11.99
MC839P	3.58	MC1455L	2.01	MC1496G	1.51	MC14457P	6.80
MC840P	1.91	MC1437P	3.14	MC1496L	3.72	MC14458P	5.75
MC846P	1.36	MC1439G	4.99	MC1496P	1.68	MC14410P	2.27
MC848L	3.17	MC1439L	4.82	MC1498L	2.42	MC14411P	17.13
MC856P	2.14	MC1439P1	3.97	MC1498S	3.55	MC14412VP	15.83
MC857L	2.46	MC1445G	4.20	MC1499L	3.16	MC14436VP	11.53
MC857P	1.50	MC1445L	4.15	MC1499S	1.82	MC14457VP	6.80
MC862L	2.27	MC1445P1	7.72	MC1499T	5.84	MC14458VP	5.84
MC958L	2.46	MC1445UDS	1.77	MC1499V	12.80	MC14490VP	4.20
MC1013P	5.00	MC1456G	2.25	MC1499P1	3.18	MC14495P	3.66
MC1302P	3.72	MC1456P1	1.96	MC1503L	18.62	MC14404P	3.52

16K Memory 8/\$16.95

4116 300ns

ALL MERCHANDISE 100% GUARANTEED

CALL US FOR VOLUME QUOTES

LS SERIES

74LS00	25	74LS163	95
74LS01	25	74LS164	95
74LS02	25	74LS165	95
74LS03	25	74LS166	2.40
74LS04	25	74LS168	1.75
74LS05	25	74LS169	1.75
74LS08	35	74LS170	1.75
74LS09	25	74LS173	.80
74LS10	25	74LS174	.95
74LS11	35	74LS175	95
74LS12	35	74LS181	2.15
74LS13	45	74LS189	9.95
74LS14	1.00	74LS190	1.00
74LS15	35	74LS191	1.00
74LS20	25	74LS192	.85
74LS21	35	74LS193	.95
74LS22	25	74LS194	1.00
74LS26	35	74LS195	95
74LS27	35	74LS196	.85
74LS28	35	74LS197	.85
74LS30	25	74LS221	1.20
74LS32	35	74LS240	1.85
74LS33	55	74LS241	1.85
74LS37	40	74LS242	1.85
74LS38	35	74LS243	1.85
74LS40	25	74LS244	1.75
74LS42	55	74LS245	2.85
74LS47	75	74LS247	.76
74LS48	75	74LS248	1.25
74LS49	75	74LS249	.99
74LS51	25	74LS251	1.30
74LS54	35	74LS253	.85
74LS55	35	74LS257	.85
74LS56	1.25	74LS258	.85
74LS73	40	74LS259	2.85
74LS74	45	74LS260	.65
74LS75	40	74LS266	.55
74LS76	40	74LS273	1.65
74LS78	50	74LS275	3.35
74LS83	75	74LS279	.55
74LS85	1.15	74LS280	1.98
74LS86	40	74LS283	1.00
74LS90	65	74LS290	1.25
74LS91	89	74LS293	1.85
74LS92	70	74LS295	1.05
74LS93	65	74LS298	1.20
74LS95	85	74LS352	1.55
74LS96	95	74LS353	1.55
74LS107	40	74LS363	1.35
74LS109	40	74LS365	.95
74LS112	45	74LS366	.95
74LS113	45	74LS367	.70
74LS114	50	74LS368	.70
74LS122	45	74LS373	1.85
74LS123	95	74LS374	1.80
74LS124	2.99	74LS377	1.45
74LS125	95	74LS378	1.18
74LS126	85	74LS379	1.35
74LS132	75	74LS385	1.90
74LS136	55	74LS386	.65
74LS137	99	74LS390	1.90
74LS138	75	74LS393	1.90
74LS139	75	74LS395	1.65
74LS145	2.00	74LS399	1.70
74LS147	2.49	74LS447	.97
74LS148	1.35	74LS490	1.95
74LS151	75	74LS668	1.69
74LS153	75	74LS669	1.89
74LS154	2.35	74LS670	2.20
74LS155	1.15	74LS674	9.65
74LS156	95	74LS682	3.20
74LS157	75	74LS683	2.30
74LS158	75	74LS684	2.40
74LS160	90	74LS685	2.40
74LS161	95	74LS688	2.40
74LS162	95	74LS689	2.40

7400 SERIES

7400	.19	74128	.55
7401	.19	74132	.45
7402	.19	74136	.50
7403	.19	74141	.65
7404	.19	74142	2.95
7405	.22	74143	2.95
7406	.22	74144	2.95
7407	.22	74145	.60
7408	.24	74147	1.75
7409	.19	74148	1.20
7410	.19	74150	1.35
7411	.25	74151	.65
7412	.30	74152	.65
7413	.35	74153	.55
7414	.55	74154	1.40
7416	.25	74155	.75
7417	.25	74156	.65
7420	.19	74157	.55
7421	.35	74159	1.65
7422	.29	74160	.85
7423	.29	74161	.70
7425	.29	74162	.85
7426	.29	74163	.85
7427	.29	74164	.85
7428	.45	74165	.85
7430	.19	74166	1.00
7432	.29	74167	1.95
7433	.45	74170	1.65
7437	.29	74172	5.95
7438	.29	74173	.75
7440	.19	74174	.89
7442	.49	74175	.89
7443	.65	74176	.89
7444	.69	74177	.75
7445	.69	74178	1.15
7446	.59	74179	1.75
7447	.69	74180	.75
7448	.69	74181	2.25
7450	.19	74182	.75
7451	.23	74184	2.00
7453	.23	74185	2.00
7454	.23	74186	18.50
7460	.23	74190	1.15
7464	.39	74191	1.15
7465	.39	74192	.79
7470	.35	74193	.79
7472	.29	74194	.85
7473	.34	74195	.85
7474	.35	74196	.79
7475	.49	74197	.75
7476	.35	74198	1.35
7480	.59	74199	1.35
7481	1.10	74221	1.35
7482	.95	74246	1.35
7483	.50	74247	1.25
7484	.50	74248	1.85
7485	.65	74249	1.95
7486	.35	74251	.75
7489	4.95	74259	2.25
7490	.35	74265	1.35
7491	.40	74273	1.95
7492	.50	74276	1.25
7493	.49	74279	.75
7494	.65	74283	2.00
7495	.55	74284	3.75
7496	.70	74285	3.75
7497	2.75	74290	.95
74100	1.00	74293	.75
74107	.30	74298	.85
74109	.45	74351	2.25
74110	.45	74365	.65
74111	.55	74366	.65
74116	1.55	74367	.65
74120	1.20	74368	.65
74121	.29	74376	2.20
74122	.45	74390	1.75
74123	.55	74393	1.35
74125	.45	74425	3.15
74126	.45	74426	.85
		74490	2.55

T.V. CIRCUITS

MC1330	1.89
MC1350	1.29
MC1358	1.79
LM380	1.29
LM386	1.50
LM565	.99
LM741	.29
LM1310	2.90
LM1800	2.99
LM1889	2.49

MISC.

8T26	1.69	3242	9.95
8T28	2.49	AY5-1013	3.95
8T95	.99	TR1602	4.95
8T96	.99	IM6402	7.95
8T97	.99	1771	24.95
8T98	.99	1791	36.95
1488	.99	UPD765	39.95
1489	.99	8272	39.95
DM8131	2.95	1793	49.95

CMOS

74C00	35	74C373	2.75	4018	.95	4093	.95
74C02	35	74C374	2.75	4019	.45	4099	1.95
74C04	35	74C901	.80	4020	.95	14409	8.95
74C08	35	74C902	.85	4021	.95	14410	8.95
74C10	35	74C903	.85	4022	1.15	14411	9.95
74C14	1.50	74C905	10.95	4023	.35	14412	12.95
74C20	35	74C906	.95	4024	.75	14419	2.95
74C30	35	74C907	1.00	4025	.35	4502	.95
74C32	.50	74C908	2.00	4026	1.65	4503	.65
74C42	1.75	74C909	2.75	4027	.65	4508	1.95
74C48	2.10	74C910	9.95	4028	.80	4510	.95
74C73	.65	74C911	10.00	4029	.95	4511	.95
74C74	.85	74C912	10.00	4030	.85	4512	.95
74C76	.80	74C914	1.95	4034	2.95	4514	1.25
74C83	1.95	74C915	2.00	4035	.85	4515	2.25
74C85	1.95	74C918	2.75	4040	.95	4516	1.55
74C86	.95	74C920	17.95	4041	1.25	4518	1.25
74C89	4.50	74C921	15.95	4042	.75	4519	1.25
74C90	1.75	74C922	5.95	4043	.85	4520	1.25
74C93	1.75	74C923	5.95	4044	.85	4522	1.25
74C95	1.75	74C925	6.75	4046	.95	4526	1.25
74C107	1.00	74C926	7.95	4047	.95	4527	1.95
74C150	5.75	74C927	7.95	4049	.55	4528	1.25
74C151	2.25	74C928	7.95	4050	.95	4531	.95
74C154	3.25	74C929	19.95	4051	.95	4532	1.95
74C157	1.75	74C930	19.95	4053	.85	4538	1.95
74C160	2.00	4000	.35	4060	1.45	4539	1.95
74C161	2.00	4001	.35	4066	.75	4543	2.70
74C162	2.00	4002	.25	4068	.40	4555	.95
74C163	2.00	4006	.95	4069	.35	4556	.95
74C164	2.00	4007	.29	4070	.35	4581	1.95
74C165	2.00	4008	.95	4071	.30	4582	1.95
74C173	2.00	4009	.45	4072	.30	4584	.95
74C174	2.25	4010	.45	4073	.30	4585	.95
74C175	2.25	4011	.35	4075	.30	4702	12.95
74C192	2.25	4012	.25	4076	.95	4724	1.50
74C193	2.25	4013	.45	4078	.30	80C07	.95
74C195	2.25	4014	.95	4081	.30	80C95	.85
74C200	5.75	4015	.95	4082	.30	80C96	.95
74C221	2.25	4016	.45	4085	.95	80C97	.95
		4017	1.15	4086	.95	80C98	1.20

DIP SWITCHES

4 position	.85
5 position	.90
6 position	.90
7 position	.95
8 position	.95

TRANSISTORS

PN2222	10/1.00	100/8.99
2N3904	10/1.00	100/8.99
2N3906	10/1.00	100/8.99
2N3055	.79	10/6.99
IN4148		25/1.00
IN4004		10/1.00

CONNECTORS

RS232 MALE	3.25
RS232 FEMALE	3.75
RS232 HOOD	1.25
S-100 ST	3.95
S-100 WW	4.95

74S00 SERIES

74S00	44	74S74	69	74S163	3.75	74S258	1.49
74S02	48	74S85	2.39	74S168	4.65	74S260	1.83
74S03	48	74S86	1.44	74S169	5.44	74S274	19.95
74S04	79	74S112	1.59	74S174	1.09	74S275	19.95
74S05	79	74S113	1.98	74S175	1.09	74S280	2.90
74S08	48	74S114	1.50	74S181	4.47	74S287	4.75
74S09	98	74S124	2.77	74S182	2.95	74S288	4.45
74S10	69	74S132	1.24	74S188	3.95	74S289	6.98
74S11	88	74S133	.98	74S189	14.95	74S301	6.95
74S15	70	74S134	.69	74S194	2.95	74S373	3.45
74S20	68	74S135	1.48	74S195	1.89	74S374	3.45
74S22	98	74S138	1.08	74S196	4.9		

4K STATIC RAMS 8/18.95

2114 LOW POWER 450ns

ALL MERCHANDISE 100% GUARANTEED

CALL US FOR VOLUME QUOTES

8200

8202	45.00
8205	3.50
8212	1.95
8214	3.90
8216	1.85
8224	2.50
8226	1.85
8228	4.95
8237	19.95
8238	4.95
8243	4.50
8250	14.95
8251	5.50
8253	9.85
8253-5	9.85
8255	5.25
8255-5	5.25
8257	9.00
8259	7.00
8272	39.95
8275	29.95
8279	10.50
8279-5	10.50
8282	6.65
8283	6.65
8284	5.80
8286	6.65
8287	6.65
8288	25.00
8289	49.95

6800

6800	6.95
6802	11.95
6809	37.95
6810	4.60
6820	4.95
6821	4.95
6828	9.95
6834	16.95
6840	14.95
6843	42.95
6844	44.95
6845	29.95
6847	15.95
6850	4.75
6852	5.75
6860	10.95
6862	11.95
6871	25.95
6875	6.95
6880	2.95

Z80

Z80	8.95
Z80A	9.95
Z80B	19.95
Z80-PIO	6.50
Z80A-PIO	8.60
Z80-CTC	6.50
Z80A-CTC	8.65
Z80-DART	15.25
Z80A-DART	18.75
Z80-DMA	17.50
Z80A-DMA	27.50
Z80-SIO/0	23.95
Z80A-SIO/0	28.95
Z80-SIO/1	23.95
Z80A-SIO/1	28.95
Z80-SIO/2	23.95
Z80A-SIO/2	28.95
Z80-SIO/9	17.95
Z80A-SIO/9	22.95

SEPTEMBER SPECIALS

4116	150ns	NEC	8 for 19.95
4116	200ns		8 for 17.50

2708		2.99	8 for 2.75ea
2716	Intel and NEC	5.95	8 for 5.50ea
2732	Intel	16.50	8 for 15.95ea
2532	Ti and Hitachi		19.95ea

MPU'S

8035	16.95
8039	19.95
8080A	3.95
8085	12.95
8086	99.95
8088	39.95
8155	11.95
8156	11.95
8185	29.95
8185-2	39.95
8741	39.95
8748	69.95
8755	49.95

6502

6502	6.95
6502A	12.95
6504	6.95
6505	8.95
6520	4.95
6522	9.95
6532	14.95
6551	14.95

Z80A			6.00ea
Z80A	PIO		6.00ea
Z80A	SIO/1		15.00ea

8251A	Intel		4.75ea
UPD 765	(8272)		35.00ea
LM323K		3.50ea	10 for 3.00ea

IC SOCKETS

1-100 100pcs		
8 pin ST	.13	.11
14 pin ST	.15	.12
16 pin ST	.17	.13
18 pin ST	.20	.18
20 pin ST	.29	.27
22 pin ST	.30	.27
24 pin ST	.30	.27
28 pin ST	.40	.32
40 pin ST	.49	.39
ST = SOLDERTAIL		
8 pin WW	.59	.49
14 pin WW	.69	.52
16 pin WW	.69	.58
18 pin WW	.99	.90
20 pin WW	1.09	.98
22 pin WW	1.39	1.28
24 pin WW	1.49	1.35
28 pin WW	1.69	1.49
40 pin WW	1.99	1.80
WW = WIREWRAP		

BEFORE YOU BUY CALL
JDR FOR THE BEST PRICE.

800-538-5000

800-662-6233

(CALIFORNIA RESIDENTS)

LS SPECIALS

LS240	.99	LS245	1.90
LS241	.99	LS373	.99
LS244	.99	SL374	1.75

(Sale Ends September 30, 1981)

LEDS

Jumbo Red	10/1.00
Jumbo Green	6/1.00
Jumbo Yellow	6/1.00
5082-7760 .43"CC	.79
MAN74 .3"CC	.99
MAN72 .3"CA	.99

DYNAMIC RAMS

4027	(250ns)	2.50	2.00
4116-150	(150ns)	8/21.95	2.65
4116-200	(200ns)	8/19.95	2.35
4116-300	(300ns)	8/16.95	2.00
4164	(200ns)	CALL	CALL

STATIC RAMS

2101	(450ns)	1.95	1.85
2102-1	(450ns)	.89	.85
21L02-1	(LP) (450ns)	1.29	1.15
2111	(450ns)	2.99	2.49
2112	(450ns)	2.99	2.79
2114	(450ns)	8/18.95	2.25
2114L-2	(LP) (200ns)	8/22.95	2.45
2114L-3	(300ns)	8/21.95	2.45
2114L-4	(LP) (450ns)	8/18.95	2.25
4044-4	(450ns)	3.49	3.25
4044-3	(300ns)	3.99	3.75
TMM2016	(200ns)	CALL	CALL
MB6116	(200ns)	CALL	CALL

LP = LOW POWER

EPROMS

1702	256 x 8	(1us)	4.95	4.50
2708	1024 x 8	(450ns)	3.95	3.50
2716	(5v) 2048 x 8	(450ns)	6.95	5.95
2758	(5v) 1024 x 8	(450ns)	9.95	8.95
2716-1	(5v) 2048 x 8	(350ns)	12.95	11.95
TMS2716	2048 x 8	(450ns)	9.95	8.95
TMS2532	(5v) 4096 x 8	(450ns)	21.95	19.95
2732	(5v) 4096 x 8	(450ns)	17.95	16.95

PROMS

74S188	(82S23)	OC	32 x 8	3.95
74S287	(82S129)	TS	256 x 4	4.75
74S288	(82S123)	TS	32 x 8	4.45
74S387	(82S126)	OC	256 x 4	5.75
74S471		TS	256 x 8	9.95
74S472	(82S147)	TS	512 x 8	16.85
74S474	(82S141)	TS	512 x 8	17.85
74S570	(82S130)	OC	512 x 4	7.80
74S571	(82S131)	TS	512 x 4	7.80

JDR MICRODEVICES, INC.

1101 South Winchester Blvd.
San Jose, California 95128
800-538-5000 800-662-6263 (Calif.)
408-247-4852



TERMS: For shipping include \$2.00 for UPS Ground; \$3.00 for UPS Blue Label Air; \$10.00 minimum order. Bay Area Residents add 8 1/2% sales tax Calif. Residents add 6% sales tax. We reserve the right to limit quantities and substitute manufacturer. Prices subject to change without notice.

LOW COST PARTS

KEY SWITCH
S.P.S.T.
125 VOLTS
RATED 4 AMPS
\$ 3.50 EA.

D.P.D.T. CENTER OFF
MINI TOGGLE
ON-OFF-ON
RATED 5 AMPS
@ 120 VOLTS
\$ 2.00 EACH

1/4" PHONE JACK
MOLDED PLASTIC
NO SWITCH
10 FOR \$1.00
100 FOR \$9.00
500 FOR \$40.00
1000 FOR \$70.00

TRANSFORMERS

120 volt primaries

6 VOLTS at 150 mA \$1.25
12 V.C.T. at 500mA \$2.50
16.5 V. at 3 AMPS \$6.50
18 VOLTS at 1 AMP \$4.50
25.2 V.C.T. at 2.8 AMP \$5.50

440/220 TO 110 VOLT TRANSFORMER

SOLA # HTBZ100
440 or 220 volts to 110 volts
Rated 100 VA
\$ 15.00

4PDT PRINTED CIRCUIT 12 VDC
14 pin style
3 amp contacts
BRAND NEW P.C. Mount
\$ 2.75 EA.

MINI SIZE S/S BUZZERS
1 1/2 to 3 volts WITH WIRE LEADS
75¢ each

1 1/2 to 3 volts WITH PIN TERMINALS
75¢ each

3 to 7 volts WITH PIN TERMINALS
75¢ each

COMPUTER GRADE CAPACITORS NEW

1,700mfd
150 VDC \$2.00
2 1/2" DIA X 4 3/4"

6,400mfd
60 VDC \$2.50
1 3/8" DIA X 1 1/4"

11,500mfd 18 VDC \$1.50
1 3/8" DIA X 3 1/4" HIGH

22,000mfd 15 VDC \$2.50
2" DIA X 2 1/2" HIGH

52,000mfd 15 VDC \$3.00
2" DIA X 4 1/2" HIGH

20 000 mfd 25 VOLTS
2" DIA. X 2 1/2" HIGH \$2.00

22 000 mfd 40 VOLTS
2" DIA. X 6" HIGH \$3.00

CLAMPS TO FIT CAPACITORS 50¢ ea.

SEND FOR FREE CATALOG!

12 VOLT D.C. ALARM BELL

bright red color
ideal for alarms
6 in. dia. bell
loud ring
\$15.00 ea.

SUPER SMALL PHOTO-FLASH

170 MFD 330 VOLT
1 1/4" x 7/8"
2 for \$1.50
10 for \$14.00

RFI LINE FILTER

for line to line & line to ground noise suppression
CORCOM #10K6
Rated: 10 amp
115/250 v
50-400 Hz
\$ 3.75 ea.
10 for \$35.00

50K SLIDE POT

Knobs for Slide Pots 20¢ each
75¢ each audio taper
3 1/2 inch long - 2 3/4 inch slide

22/44 EDGE CONNECTOR

TIN SOLDER TAIL .156" x .200"
LARGE QUANTITIES AVAILABLE
\$1.35 each 10 for \$12.50

4PDT RELAY

14 pin style
3 amp contacts
120 volt a.c. coil
Used but fully tested
\$ 1.70 EACH
LARGE QUANTITIES AVAILABLE
SOCKETS FOR RELAY 50¢ each

FLASHER L E D

Litronix FRL-4403
diffused red led with built in flashing unit
1 1/4 package
pulse rate 3Hz @ 20 ma
2 for \$1.70

SUB MINI L.E.D.

.079" x .098"
20mA at 1.75v
10 for \$1.00
200 for \$18.00
400 for \$32.00
1000 for \$70.00

BI-POLAR L.E.D.

THREE COLOR IN ONE LED.
RED ON DC, GREEN ON REVERSE DC, YELLOW ON AC.
2 FOR \$1.70

L.E.D.'S

RED JUMBO DIFFUSED
10 for \$1.50
GREEN JUMBO DIFFUSED
10 for \$2.00
YELLOW JUMBO DIFFUSED
10 for \$2.00

RECHARGEABLE SOLID - GEL BATTERIES

6 VOLTS 3 AMP/HR.
2 5/8 x 1 1/2 x 5 IN. \$7.50

6 VOLTS 6 AMP/HR.
3 1/2 x 2 x 4 1/2 IN. \$10.00

6 VOLTS 7 1/2 AMP/HR.
4 1/2 x 2 x 4 1/2 IN. \$12.50

ALL ELECTRONICS CORP.

905 S. Vermont Ave.
P.O. BOX 20406
Los Angeles, Calif. 90006
(213) 380-8000

Mon. - Fri. Saturday
9 AM - 5 PM 10 AM - 3 PM

TERMS
• Quantities Limited
• Min. Order \$10.00
• Add \$2.00 Shipping USA
• Calif. Res. Add 6%
• Prompt Shipping

VIDEO PRODUCTS & ACCESSORIES

36 Channel Up Converter for TV & VTR

Cable VHF to UHF
1-3 pieces \$29.95
4 pieces & up \$24.95

- Model V5736
- Allows complete programming of VTR
 - Watch or record any combination of standard or Pay-TV programs
 - Receives Midband and Superband channels on UHF
 - For Beta/VHS type recorders

TEKNIKA Wireless Remote Control TV Tuner

Model 6301

OUR PRICE \$109.95
Reg. \$169.95

- Easy to install; just 4 wires
- Electronic channel selection and indication. VHF: 2-12, UHF: 14-83,
- CATV midband; A-1
- Ultra-Infrared Beam Control
- Master power switch

TV Accessories

7002 VHF/FM Amplifier \$ 9.95 ea.
7004 VHF/FM Amplifier \$12.95 ea.

Coax Accessories

F3F 3ft, 75 ohms RG59 cable, F-F connector \$1.25 ea.
F6F 6ft, 75 ohms RG59 cable, F-F connector \$1.50 ea.

CA-2411 5-900 MHz, 2-way mini splitter \$1.75 ea.

CA-2444 5-9000 MHz, 4-way splitter \$2.95 ea.

DCA-S/A/B A/B CATV/MATV Switch \$9.00 ea.

FORDHAM

855 Conklin St. Farmingdale, N.Y. 11735

- Master Charge
- BankAmericard
- VISA = COD
- Money Order
- Check

ADD FOR SHIPPING AND INSURANCE
\$251.00 to \$500.00 \$ 4.50
\$501.00 to 750.00 6.00
\$751.00 to 1000.00 12.00
over 1000.00 12.50

COO's extra

N.Y. State residents add appropriate sales tax
Minimum order \$25 plus \$4.50 shipping and handling.

TOLL FREE (800)645-9518
in N.Y. State call (516) 752-0050



DON'T BLAME THE SOFTWARE!

Pat. #4,259,705

Power Line Spikes and Hash often cause memory loss or erratic operation. Often floppies, printer & processor interact!

OUR patented ISOLATORS eliminate equipment interaction AND curb damaging Power Line Spikes, Surges and Hash.

Filtered 3-prong sockets and integral Spike Suppression. 125 VAC, 15 Amp, 1875 W Total - 1 KW per socket.

ISO-1 ISOLATOR. 3 Filtered Sockets; 1000 Amp 8/20 usec Spike Suppressor \$62.95

ISO-4 ISOLATOR. 6 Filtered Sockets; 1000 Amp 8/20 usec Spike Suppressor \$106.95

ISO-3 SUPER-ISOLATOR. 3 DUAL filtered Sockets; 2000 Amp 8/20 usec Spike Suppressor \$94.95

ISO-7 SUPER-ISOLATOR. 5 DUAL filtered Sockets; 2000 Amp 8/20 usec Spike Suppressor \$154.95

Master-Charge, Visa, American Express
TOLL FREE ORDER DESK 1-800-225-4878
(except AK, HI, MA, PR & Canada)

Electronic Specialists, Inc.
171 South Main Street, Natick, MA 01760
Technical & Non-800: 1-617-655-1532

CIRCLE 67 ON FREE INFORMATION CARD

GUARANTEED LOWEST PRICES ON PRIME ICS

from Vermont Electronics Dept. 1 312 W. Vermont, Suite B Anaheim, CA 92805

- We ship all orders within 24 hrs. of receipt.
- We do not back order.
- Immediate refunds on items on our stock.

7400	.16	7475	20	LM104AH	3.55
74H00	.24	7476	48	LM120H-5v	3.10
74L00	.24	7483	55	LM204AH	2.55
7402	.16	7489	1.40	LM220H-5v	2.10
74L02	.24	7493J	.35	LM304AH	1.55
7403	.16	74L93J	52	LM305AH	80
74L03	.24	7495	52	LM306H	2.60
7404	.20	74L95	78	LM307H	23
74H04	.30	7496	52	LM308CH	80
74L04	.30	74100	1.10	LM311CH	70
7406	.22	74122J	.32	LM312H	1.95
74L06	.33	74145	64	LM319H	1.00
7410	.16	74153	47	LM320H-5v	1.10
74L10	.24	74157	52	LM320K-5v	
7420	.16	74162	.70	Bv. 12v. 15v	1.10
7426	.22	74164	70	LM340K-6v.	
7430	.16	74165	.70	18v. 24v	1.10
74L30	.24	74177	64	LM567CN	85
7440J	.16	74180	64	sig5741	45
74H40	.24	74182J	64	LM746N	50
7441AJ	70	74189	1.56	LM75107AN	90
7445	60			LM75452N	40
7451	16	sig8T20	3.95	LM75453N	40
74H51	24	sig8470A	1.40		
7455	16			Memories:	
74L55	24	DM8123N	1.30		
7473	28	DM8288N	1.15	sig8223	3.95
74L73	42	DM8599N	1.56	sig8225	3.95
7474	28	DM8880N	1.10	MM1101AN	1.15
74L74	42			MM1103N	85

FREE Self-courting IQ test (Retail \$9.95) with order over \$25.00. IQ test may be ordered separately. \$6.95 each. 10 for \$19.95. Guaranteed to be accurate.

Much wider selection of IC's and transistors. 74xxx, 48xxx, 25xxx, DM8xxx, LM, MM, AM, DM, LH, NH, 74xxx, \$1 for catalog, send free with order.

Send Mail Orders to Vermont Electronics Dept. 1 312 W. Vermont, Suite B Anaheim, CA 92805

Standard Shipping Charges \$0.01-\$24.99 \$2.00 \$25.00-\$49.99 \$2.00 \$50.00-\$99.99 \$2.00 \$100.00-\$999.99 \$2.00 \$1000.00-up \$2.00

Volume Discount Schedule
\$0.01-\$24.99 net
\$25.00-\$49.99 -5%
\$50.00-\$99.99 -10%
\$100.00-\$999.99 -15%
\$1000.00-up -20%

24 hr. Order Desk (714) 956-4634
10% surcharge on RUSH ORDERS
Calif. Res. add 6% sales tax

CIRCLE 63 ON FREE INFORMATION CARD 123

BULLET ELECTRONICS

P.O. BOX 401244R
GARLAND, TX. 75040
(214) 278-3553

Sound Effects Kit \$18.50

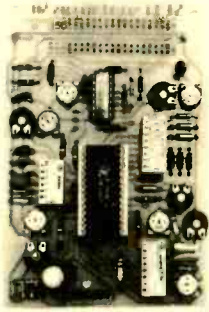

The SE-01 is a complete kit that contains all the parts to build a programmable sound effects generator. Designed around the new Texas Instruments SN76477 Sound Chip, the board provides banks of MINI DIP switches and pots to program the various combinations of the SLF Oscillator, VCO, Noise, One Shot, and Envelope Controls. A Quad Op Amp IC is used to implement an Adjustable Pulse Generator, Level Comparator and Multiplex Oscillator for even more versatility. The 3 1/2" x 5" PC Board features a prototype area to allow for user added circuitry. Easily programmed to duplicate Explosions, Phasor Guns, Steam Trains, or almost an infinite number of other sounds. The unit has a multiple of applications. The low price includes all parts, assembly manual, programming charts, and detailed 76477 chip specifications. It runs on a 9V battery (not included). On board 100mW amp will drive a small speaker directly, or the unit can be connected to your stereo with incredible results! (Speaker not included). 76477 is included. Available separately for \$3.15 each.

AY3-8910 PROGRAMMABLE SOUND GENERATOR

The AY3-8910 is a 40 pin LSI chip with three oscillators, three amplitude controls, programmable noise generator, three mixers, an envelope generator, and three D/A converters that are controlled by 8 BIT WORDS. No external pots or caps required. This chip hooked to an 8 bit microprocessor chip or Bus (8080, Z80, 6800 etc.) can be software controlled to produce almost any sound. It will play three note chords, make bangs, whistles, sirens, gunshots, explosions, bleets, whines, or grunts. In addition, it has provisions to control its own memory chips with two IO ports. The chip requires +5V @ 75ma and a standard TTL clock oscillator. A truly incredible circuit.

\$12.95 W/Basic Spec Sheet (4 pages)
60 page manual with S-100 interface instructions and several programming examples. \$3.00 extra

MANY OTHER COMPONENTS AND KITS AVAILABLE IN OUR COMPLETE CATALOG. CALL OR WRITE FOR FREE CATALOG.

Doomsday Alarm Kit \$9.95

If you have trouble sleeping and you would like the rest of the neighborhood to share your misery then this little kit will be for you! There is no way to accurately describe the unearthly howls, screams and tones that come out of this kit. Four separate tone oscillators are mixed, cancelled and stepped at a varying rate. 10 Watts of crazy sounds. A great fun kit or a practical burglar alarm. Complete with PC board and all necessary components less speaker. For 6-12 VDC. ORDER DA-02.

Overvoltage Protection Kit \$6.95

Protect your expensive equipment from overvoltage conditions. Every computer should have one! Works with any fused DC power source from 10 to 20 volts up to 25 amps.

7 Watt Audio Amp Kit \$5.95

SMALL, SINGLE HYBRID IC AND COMPONENTS FIT ON A 2" x 3" PC BOARD (INCLUDED). RUNS ON 12VDC GREAT FOR ANY PROJECT THAT NEEDS AN INEXPENSIVE AMP. LESS THAN 3% THD @ 5 WATTS. COMPATIBLE WITH SE-01 SOUND KIT

Stereo AMP/Power Supply Board

Takes low level audio and drives 8 ohm speakers ON-BOARD Rectifiers and Filter supply power for AMP AND TUNER, VOLUME, BALANCE, and TONE SLIDE CONTROLS

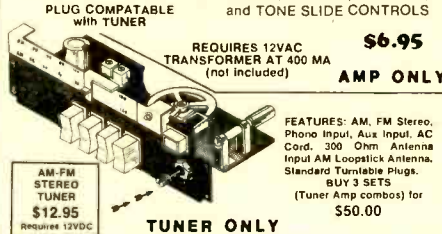

PLUG COMPATIBLE with TUNER
REQUIRES 12VAC TRANSFORMER AT 400 MA (not included)
\$6.95 AMP ONLY

FEATURES: AM, FM Stereo, Phono Input, Aux Input, AC Cord, 300 Ohm Antenna Input, AM Loopstick Antenna, Standard Turntable Plugs.
BUY 3 SETS (Tuner Amp combos) for \$50.00

AM-FM STEREO TUNER \$12.95 (Requires 12VDC)
TUNER ONLY

- NO C.O.D.'s
- SEND CHECK M.O. OR CHARGE CARD NO.
- PHONE ORDERS ACCEPTED ON VISA AND MASTERCARD ONLY.
- ADD 5% FOR SHIPPING
- TX. RES. ADD 5% STATE SALES TAX
- ALL FOREIGN ORDERS ADD 30% FOR SHIPPING CHARGES.
- U.S. FUNDS ONLY.

(214) 278-3553

The Greatest Breakthrough In Electronic Music Ever!

The Super Music Maker
REVISION 2
\$24.95
(Basic Kit)

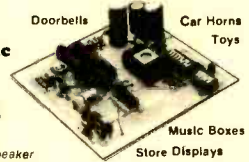

Does not include speaker switches or 2708 ROM

Now you can play hundreds of songs using the Bullet Super Music Maker. The unit features a single factory programmed microprocessor IC that comes with 20 pre-programmed short tunes. By adding the additional PROMS (2708's) the system can be expanded to play up to 1000 notes per PROM. Just think... a compact electronic instrument that will play dozens, hundreds or even thousands of selections of music. The kit comes with all electronic components (less the PROM), and a drilled, plated and screened PC Board which measures 4" x 4". The 7 watt amplifier section is on the same PC board and drives an 8 ohm speaker (not included), from a whisper to ear splitting volume. Since the unit works on 12 VDC or 12 VAC, vehicle or portable operation is possible. What do you get for \$24.95? Everything but a speaker, transformer, case, switches, and PROM. Additional 2708 albums containing popular tunes are available for \$15.00 each or you can program your own PROMS using information provided with the kit instructions. Lists of available PROM albums are available on request. (Note: Unit plays electronic music one note at a time, it is not possible to play chords or a melody with harmony simultaneously.)

- * Envelope control gives decay to notes.
 - * "Next tune" feature allows sequential playing of all songs.
 - * On board inverter allows single voltage (+12) operation.
- OPTIONAL ACCESSORIES
- | | | |
|--|------------------------|----------|
| DIP Switches | One 8 pos., One 5 pos. | 2.00/Set |
| (Can be directly soldered to PC Bd. to access tunes) | | |
| Rotary Switches | Two 5 position | 2.50/Set |
| (For remote wiring to PC Bd. to access tunes) | | |
| Attractive Plastic Case | | 6.50 |
| Wallplug Transformer | | 3.00 |
| (For operation on 117VAC house voltage) | | |

PMC PERSONAL COMPUTER

Ideal for small businesses, schools, colleges, homes, etc. Suitable for the experienced, inexperienced, hobbyist, teacher, etc.



ONLY \$575
POSTAGE \$20

EG3000 Series

WITH NEW EXTRA KEYS!

• 16K user RAM plus extended 12K Microsoft BASIC in ROM • Fully TRS-80 Level II software compatible • Huge range of software already available • Self contained, PSU, UHF modulator, and cassette • Simply plugs into video monitor or UHF TV • Full expansion to disks and printer • Absolutely complete — just fit into mains plug.



SHARP PC1211 \$190

COMPUTER POWER THAT CAN NOW BE CARRIED IN YOUR POCKET!

• Programs in BASIC • "QWERTY" Alphabetic Keyboard • 1.9K Random Access Memory • Long Battery Life.

TV GAME BREAK OUT KIT

Has got to be one of the world's greatest TV games. You really get hooked. Has also 4 other pinball games and lots of options. Good kit for up-grading old amusement games.



MINI KIT PCB, sound & vision modulator, memory chip and de-code chip. Very simple to construct. \$30.00 OR PCB \$6.00 MAIN LSI \$17.00

TTL SALE

74LS00 \$0.15	74LS74 \$0.45	74LS365 \$0.75
75LS04 \$0.15	74LS86 \$0.55	74LS373 \$2.20
74LS05 \$0.20	74LS93 \$0.90	Z80A \$5.50
74LS10 \$0.29	74LS157 \$1.20	Z80 \$4.20
74LS32 \$0.35	74LS165 \$1.75	REG. 7805 \$0.90

SOCKETS LOW PROFILE

14 PIN \$0.10	18 PIN \$0.15	24 PIN \$0.25
16 PIN \$0.10	20 PIN \$0.15	40 PIN \$0.30

10V Power Adapter 600ml. \$6.90 UHF Modulators \$9.90

GET YOURSELF A NEW EPSON MX80 & MX70 PRINTER AND SAVE A FORTUNE

Price on application
Interface Cards for Apple, Pet, TRS80, and PMC — RS232 Interface Cards not necessary for parallel.



Full TRS80

POSTAGE \$20

COMP PRO MIXER

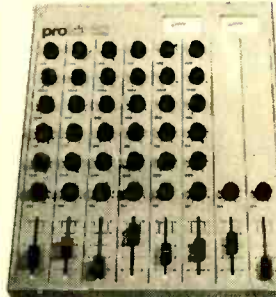

Professional audio mixer that you can build yourself and save over \$200.

Only \$199 for complete kit.
power supply \$50.00
POSTAGE \$20

ACCESSIT AUDIO ADD-ONS

LOOK! MICROACE/SINCLAIR USERS

8K FLOATING POINT SUPER ROM PACK

WITH NEW MANUAL ONLY \$35

MICROACE/SINCLAIR VIDEO UPGRADE KIT

Only runs with NEW ROM (Smooth screen display) ONLY \$29

MICROACE/SINCLAIR 16K RAM PLUS EXPANSION BOARD

3 SLOTS WITH EXTRA POWER SUPPLY
16K ONLY \$149
4K ONLY \$110



MicroAce A COMPLETE COMPUTER

A new generation of miniature computers

2K Kit ONLY \$149
Post and Packing FREE

Sinclair is a Registered Trademark of Sinclair Research Ltd.



Please make checks and money orders payable to MicroAce or phone your order quoting Master Charge, Visa, Diners Club or American Express number for immediate despatch. Add 6% Tax for Shipments inside California. MicroAce, 1348 East Edinger, Santa Ana, California, Zip Code 92705. Telephone: (714) 547 2526

ramsey

the first name in Counters!



9 DIGITS 600 MHz \$129⁹⁵ WIRED

PRICES

CT-90 wired, 1 year warranty	\$129.95
CT-90 Kit, 90 day parts warranty	
AC-1 AC adapter	109.95
BP-1 Nicad pack + AC Adapter/Charger	3.95
OV-1 Micro-Power Oven time base	12.95
External time base input	49.95
	14.95

The CT-90 is the most versatile, feature packed counter available for less than \$300.00! Advanced design features include: three selectable gate times, nine digits, gate indicator and a unique display hold function which holds the displayed count after the input signal is removed! Also, a 10MHz TCXO time base is used which enables easy zero beat calibration checks against WWV. Optionally, an internal nicad battery pack, external time base input and Micro-power high stability crystal oven time base are available. The CT-90, performance you can count on!

SPECIFICATIONS:

Range:	20 Hz to 600 MHz
Sensitivity:	Less than 10 MV to 150 MHz Less than 50 MV to 500 MHz
Resolution:	0.1 Hz (10 MHz range) 1.0 Hz (60 MHz range) 10.0 Hz (600 MHz range)
Display:	9 digits 0.4" LED
Time base:	Standard-10,000 mHz, 1.0 ppm 20-40°C. Optional Micro-power oven-0.1 ppm 20-40°C
Power:	8-15 VAC @ 250 ma

7 DIGITS 525 MHz \$99⁹⁵ WIRED



SPECIFICATIONS:

Range:	20 Hz to 525 MHz
Sensitivity:	Less than 50 MV to 150 MHz Less than 150 MV to 500 MHz
Resolution:	1.0 Hz (5 MHz range) 10.0 Hz (50 MHz range) 100.0 Hz (500 MHz range)
Display:	7 digits 0.4" LED
Time base:	1.0 ppm TCXO 20-40°C
Power:	12 VAC @ 250 ma

The CT-70 breaks the price barrier on lab quality frequency counters. Deluxe features such as: three frequency ranges - each with pre-amplification, dual selectable gate times, and gate activity indication make measurements a snap. The wide frequency range enables you to accurately measure signals from audio thru UHF with 1.0 ppm accuracy - that's .0001%! The CT-70 is the answer to all your measurement needs, in the field, lab or ham shack.

PRICES:

CT-70 wired, 1 year warranty	\$99.95
CT-70 Kit, 90 day parts warranty	
AC-1 AC adapter	84.95
BP-1 Nicad pack + AC adapter/charger	3.95
	12.95

7 DIGITS 500 MHz \$79⁹⁵ WIRED



PRICES:

MINI-100 wired, 1 year warranty	\$79.95
AC-Z Ac adapter for MINI-100	3.95
BP-Z Nicad pack and AC adapter/charger	12.95

Here's a handy, general purpose counter that provides most counter functions at an unbelievable price. The MINI-100 doesn't have the full frequency range or input impedance qualities found in higher price units, but for basic RF signal measurements, it can't be beat! Accurate measurements can be made from 1 MHz all the way up to 500 MHz with excellent sensitivity throughout the range, and the two gate times let you select the resolution desired. Add the nicad pack option and the MINI-100 makes an ideal addition to your tool box for "in-the-field" frequency checks and repairs.

SPECIFICATIONS:

Range:	1 MHz to 500 MHz
Sensitivity:	Less than 25 MV
Resolution:	100 Hz (slow gate) 1.0 KHz (fast gate)
Display:	7 digits, 0.4" LED
Time base:	2.0 ppm 20-40°C
Power:	5 VDC @ 200 ma

8 DIGITS 600 MHz \$159⁹⁵ WIRED



SPECIFICATIONS:

Range:	20 Hz to 600 MHz
Sensitivity:	Less than 25 mv to 150 MHz Less than 150 mv to 600 MHz
Resolution:	1.0 Hz (60 MHz range) 10.0 Hz (600 MHz range)
Display:	8 digits 0.4" LED
Time base:	2.0 ppm 20-40°C
Power:	110 VAC or 12 VDC

The CT-50 is a versatile lab bench counter that will measure up to 600 MHz with 8 digit precision. And, one of its best features is the Receive Frequency Adapter, which turns the CT-50 into a digital readout for any receiver. The adapter is easily programmed for any receiver and a simple connection to the receiver's VFO is all that is required for use. Adding the receiver adapter in no way limits the operation of the CT-50, the adapter can be conveniently switched on or off. The CT-50, a counter that can work double-duty!

PRICES:

CT-50 wired, 1 year warranty	\$159.95
CT-50 Kit, 90 day parts warranty	
RA-1, receiver adapter kit	119.95
RA-1 wired and pre-programmed (send copy of receiver schematic)	14.95
	29.95

DIGITAL MULTIMETER \$99⁹⁵ WIRED



PRICES:

DM-700 wired, 1 year warranty	\$99.95
DM-700 Kit, 90 day parts warranty	
AC-1, AC adaptor	79.95
BP-3, Nicad pack + AC adapter/charger	3.95
MP-1, Probe kit	19.95
	2.95

The DM-700 offers professional quality performance at a hobbyist price. Features include: 26 different ranges and 5 functions, all arranged in a convenient, easy to use format. Measurements are displayed on a large 3 1/2 digit, 1/2 inch LED readout with automatic decimal placement, automatic polarity, overrange indication and overload protection up to 1250 volts on all ranges, making it virtually goof-proof! The DM-700 looks great, a handsome, jet black, rugged ABS case with convenient retractable tilt bail makes it an ideal addition to any shop.

SPECIFICATIONS:

DC/AC volts:	100uV to 1 KV, 5 ranges
DC/AC current:	0.1 uA to 2.0 Amps, 5 ranges
Resistance:	0.1 ohms to 20 Megohms, 6 ranges
Input impedance:	10 Megohms, DC/AC volts
Accuracy:	0.1% basic DC volts
Power:	4 'C' cells

AUDIO SCALER

For high resolution audio measurements, multiplies UP in frequency.

- Great for PL tones
- Multiplies by 10 or 100
- 0.01 Hz resolution!

\$29.95 Kit \$39.95 Wired

ACCESSORIES

Telescopic whip antenna - BNC plug	\$ 7.95
High impedance probe, light loading	15.95
Low pass probe, for audio measurements	15.95
Direct probe, general purpose usage	12.95
Tilt bail, for CT 70, 90, MINI-100	3.95
Color burst calibration unit, calibrates counter against color TV signal	14.95

COUNTER PREAMP

For measuring extremely weak signals from 10 to 1,000 MHz. Small size, powered by plug transformer-included.

- Flat 25 db gain
- BNC Connectors
- Great for sniffing RF with pick-up loop

\$34.95 Kit \$44.95 Wired

ramsey electronics, inc.

2575 BAIRD RD. • PENFIELD, NY 14526



PHONE ORDERS
CALL 716-586-3950

U.R.M.S.

Satisfaction guaranteed - examine for 10 days - if not pleased, return in original form for refund. Add 5% for shipping - insurance to a maximum of \$10. Overseas add 15% COD, add \$2. Orders under \$10, add \$1.50. NY residents, add 7% tax.

SEPTEMBER 1981

CIRCLE 7 ON FREE INFORMATION CARD

2102 MISC.

450NS	.95
8038	2.95
ME555	.27
MS-1013A	4.25
1480	1.10
1489	1.10
8735	1.30
8728	1.30
8212	2.75
8216	2.75
65405CR	.95
17410TRIC	.95
7905	.85
7906	.85
7915	.85
7918	.85
7905	.85
7906	.85
7908	.85
7912	.85
MC1330AIP	1.60
MC1350P	1.15
MC1358P	1.50
LM380	1.20
LM555N	.95
LM741	1.30
MC1458P	.55
LM720	.30
LM338	1.75
1103A	.75
UPD765	17.85
Floppy disk	w/zipoc
Controller	
LM741	1.95
TMS4400	1.40
MC4008P	1.75
LM3025	1.55
D3624	1.95
D3001	1.95
D3002	1.95

\$145.00 **\$155.00**

Tbar INCORPORATED

Apple Expansion Kit
16K Memory Add-On
Includes Instructions \$25.95

TRS80
16K Add-On
Instructions &
Dip Switches
\$25.95

SN7400N	.30
SN7402N	.22
SN7404N	.21
SN7408N	.22
SN7410N	.18
SN7412N	.20
SN7413N	.22
SN7414N	.25
SN7416N	.29
SN7417N	.29
SN7420N	.17
SN7425N	.17
SN7430N	.28
SN7438N	.24
SN7440N	.18
SN7442N	.45
SN7443N	.42
SN7445N	.64
SN7451N	.19
SN7454N	.19
SN7474N	.27
SN7475N	.35
SN7482N	.30
SN7483N	.49
SN7489N	.45
SN7495N	.50
SN7498N	.50
SN74122N	.90
SN74136N	.95
SN74141N	.90
SN74151N	.55
SN74153N	.50
SN74154N	1.25
SN74155N	.75
SN74157N	.77
SN74160N	.80
SN74161N	.85
SN74163N	.85
SN74164N	.87
SN74165N	.55
SN74174N	.88
SN74175N	.70
SN74180N	.75
SN74181N	1.15
SN74393N	1.05
74500	.39
74502	.45
74503	.38
74504	.39
74505	.39
74510	.30
74515	.45
74520	.55
74522	.55
74523	.49
74537	.55
74550	.65
74551	.75
74564	.55
74574	.65
74596	.95
745112	1.95
745132	1.45
745138	.75
745140	1.00
745158	.75
745174	1.35
745175	1.35
745182	.75
745201	6.75
745240	2.75
745282	2.95
745251	2.75
745287	2.95
745244	2.95
745473	9.50
745470	9.25
745471	9.50
745472	9.50
745473	9.50
745474	9.50

EPSON MX-80

\$560.00

APPLE INTERFACE & CABLE \$110.00

MSM5832 MICROPROCESSOR CLOCK/CALENDAR

GENERAL DESCRIPTION

The MSM5832 is a monolithic, metal gate CMOS integrated circuit that functions as a real-time clock/calendar. It is designed for use in a wide range of applications. The on-chip 32-bit binary counter is capable of counting down to zero. It also includes a 12-bit BCD decade counter. The calendar portion of the device is controlled by the address (chip select) input and holds date. Clock functions include 120 days for the year, 31 days for the month, and 7 days for the week. The MSM5832 normally operates from a 5 volt, 1% supply. Battery back-up operation (up to 2 years) is available. The MSM5832 is packaged in an 18-pin dual in-line package (DIP).

\$7.45 / xtal \$3.85

74LS900	.28
74LS902	.28
74LS903	.28
74LS904	.28
74LS905	.22
74LS906	.28
74LS907	.28
74LS910	.26
74LS914	.22
74LS920	.22
74LS921	.28
74LS926	.40
74LS927	.27
74LS928	.37
74LS930	.29
74LS932	.31
74LS934	.29
74LS942	.63
74LS948	.77
74LS974	.36
74LS975	.55
74LS986	.45
74LS990	.50
74LS993	.55
74LS996	.80
74LS107	.43
74LS113	.45
74LS122	.45
74LS123	.60
74LS125	.80
74LS126	.70
74LS138	8.4
74LS139	5.9
74LS151	4.9
74LS153	4.9
74LS157	.85
74LS158	.80
74LS161	.80
74LS163	.80
74LS164	.85
74LS165	.85
74LS166	.85
74LS169	1.55
74LS170	1.75
74LS174	.85
74LS175	.85
74LS190	.85
74LS191	1.25
74LS195	.85
74LS197	.78
74LS231	1.25
74LS240	1.65
74LS241	1.65
74LS243	1.55
74LS245	2.45
74LS251	.85
74LS252	.85
74LS257	.85
74LS260	.55
74LS273	1.55
74LS279	4.5
74LS290	1.25
74LS293	1.65
74LS300	.85
74LS307	.75
74LS373	1.45
74LS377	1.25
74LS380	1.55
74LS370	1.85

"APPLE II Plus"

48k - \$1199.00

64k - \$1399.00

video 100

\$12900

12 inch
12MHz
GREEN PHOS
VIDEO MONITOR

\$365.00

video 100

\$15500

12 inch
12MHz
GREEN PHOS
VIDEO MONITOR

\$365.00

ATARI 800™ COMPUTER SYSTEM

Best Buy

800 COMPUTER w/48K \$898.00

ATARI PERIPHERALS:

Printer (4125)	\$115.00	Printer (3177)	\$115.00
Scanner (4125)	\$65.00	Disk Drive (5165)	\$65.00
Interface (631)	\$115.00	Mouse (5165)	\$15.00
Monitor (4125)	\$115.00	Mouse (5165)	\$15.00
Mouse (5165)	\$15.00	Mouse (5165)	\$15.00
Mouse (5165)	\$15.00	Mouse (5165)	\$15.00
Mouse (5165)	\$15.00	Mouse (5165)	\$15.00
Mouse (5165)	\$15.00	Mouse (5165)	\$15.00
Mouse (5165)	\$15.00	Mouse (5165)	\$15.00
Mouse (5165)	\$15.00	Mouse (5165)	\$15.00

1981 I.C. MASTER \$59.95

Synertek "KTM-3"

LOW COST TERMINAL WITH KEYBOARD AND VIDEO 100

\$1550.00

IQ120 \$689.

POWER SUPPLY MODEL #CP198

input → 110/125v
output → 5vdc

At 6amps

\$29.95

Qty. price avail.

LOGIC PROBE KIT

Complete, easy-to-follow instructions help make this a one-night project.

\$18.95

Logic Probes

LP-1 \$40.

LP-2 \$30.

LP-3 \$60.

CONCORD COMPUTER PRODUCTS

1971 SO STATE COLLEGE ANAHEIM, CALIF. 92806

(714) 937-0637

CHECK - M/O

VISA

\$10. MIN ORDER / CA RES ADD 6% FRT.

send \$100 for '81' catalog

CIRCLE 51 ON FREE INFORMATION CARD

The ultimate APPLE® copy program

COPY II PLUS

\$39.95

VERSATILE - Copy II Plus copies multiple formats - DOS 3.2, 3.3, PASCAL, FORTRAN and most "protected" diskettes!

FAST - Copy II Plus copies nearly any diskette in less than one minute. That's faster than most standard copy programs. Written entirely in ultra fast assembly language.

Search no more for that universal copy program. Copy II Plus is the most advanced copy program available for the Apple II Computer. Compare capability, compare speed, compare price, then call or write to order Copy II Plus. Requires Apple II with 48K and at least one Disk Drive.

CENTRAL POINT Software, Inc.

**P.O. Box 3563
Central Point, OR 97502
(503) 773-1970**



or check

Deliveries from stock. No C.O.D.'s
Apple is a registered trademark of Apple Computer, Inc.

CIRCLE 30 ON FREE INFORMATION CARD

ETCO

CABLE TV CONVERTERS AND OTHER GOOD STUFF!

SMASHING ALL SALES RECORDS - OUR NEW 30 CHANNEL CABLE TV CONVERTER!

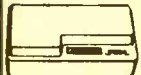

Converts mid & super band cable channels for viewing on your TV set!
No. 349AE047

39⁹⁵ \$34.95 ea./5

HOT NEW IMPORT! REMOTE CONTROL 30 CHANNEL CABLE TV CONVERTER!

89⁹⁵ \$79.95 ea./5
\$74.95 ea./10

Includes remote TV on/off switch and fine tuning control
No. 349VA275



ETCO MKII WIRELESS - THE ULTIMATE CABLE TV CONVERTER!



Set TV to channel 3, and the hand-held remote control does it all!
No. 3492A008

189⁰⁰

VIDCOR 2000 CONVERTER ELIMINATES PROBLEMS WHEN VIDEOTAPING FROM CABLE TV

89⁹⁵

Restores your VCR's capability for programming. Restores remote channel control. Enables videotaping of one cable program while watching another.
No. 349VA950



UNUSUAL FACTORY SURPLUS MID-BAND - SUPER-BAND CABLE TV TUNER

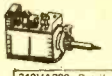

Converts cable channels to a common IF frequency. Expertly restores - build cable converters, decoders, etc. With schematic. No. 349VA342

19⁹⁵ \$17.50 ea./10

349VA389 - Detailed schematic & spec sheet \$1.50

FACTORY SURPLUS UHF TUNERS

4⁹⁵ \$3.95 ea./10

Brand new production surplus. All solid state. Ideal for experimental work building, cable TV converters, etc. No. 349SU099



MINIATURE FM WIRELESS MICROPHONE



Hides in the palm of your hand. Reception on any standard FM radio or receiver.
No. 349VA482

29⁹⁵ \$27.50 ea./5
\$24.95 ea./10

QUARTER-MILE WIRELESS MICROPHONE & RECEIVER SYSTEM

69⁹⁵ \$49.95 ea./5

FCC approved crystal controlled wireless mike & receiver. All battery operated. Electret wide range response. VU meter.
No. 349VA093



FACTORY SURPLUS VHF / UHF "TWIN" VARACTOR TUNERS!



Admiral No. NC 1343-1. BRAND NEW! Ideal for building or repairing electronically tuned TV "FRONT ENDS". A hard to find item at a sensational price!
No. 349VC308

39⁹⁵ \$34.95 ea./5

DUMPING! NORELCO ENDLESS LOOP CASSETTES!

4⁹⁵ \$4.49 ea./10

Impossible to find at any price!
3 minutes - No. 349VA605
6 minutes - No. 349VA606



IN STOCK - THE MURA CORDLESS TELEPHONE SYSTEM!



Answers & originates calls with this wire less push-button 400 ft. range! Rechargeable! Use with rotary, touch systems!
No. 349VA274

144⁸⁸ \$129.95 ea./5

SALE OF QUARTZ BATTERY-OPERATED CLOCK MOVEMENTS!

9⁹⁵ \$8.95 ea./5

Accuracy of 1 min./year, up to 4-year operation on 1 alkaline "C" cell, imported from West Germany. No. 349VA561
349VA565 Matching hands - \$2.49/set. \$1.95/set / 5



20 AMP REGULATED 12VDC POWER SUPPLY!



13.8 vdc no load, 12.5 vdc full load. Easily handles ham station, marine radio, SSB linear up to 400w P.E.P. Brand new, factory sealed. 110 VAC. No. 349VA394

69⁸⁸ \$59.88 ea./5

FREE

OUR LATEST 98 PAGE FASCINATING CATALOG - jam-packed with unique items, electronic bargains and unusual offers. Write or circle the information card number below.



ETCO ELECTRONICS NORTH COUNTRY SHOPPING CENTER PLATTSBURGH, N.Y. 12901

Check with order, please. Visa & Mastercard OK. (Sorry, no C.O.D.'s. Add 15% for UPS & Handling (Excess refunded). N.Y. State residents add 7% sales tax. Dealer & Export inquiries invited. Our telephone order desk never closes. Call 1-518-561-8700.

CIRCLE 74 ON FREE INFORMATION CARD

DON'T FORGET

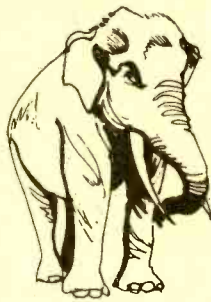

USE YOUR READER SERVICE CARD

SIMPLE SIMON PART KITS

MITSUMI UHF TUNER

\$34.95

FREQ. RANGE UHF 470V - 89MHz CHANNELS 14-83 OUTPUT CHAN 3

- VT1-SW Varactor UHF tuner, model UES-A55F \$34.95
 - CB1-SW Printed circuit board, pre-drilled \$18.95
 - TP7-SW PCB potentiometer, 1-20K, 1-K & 5-10K (7 pcs) \$5.95
 - FR35-SW Resistor kit: 1/4W, 5% carbon film (32 pcs) \$4.95
 - PT1-SW Power transformer: pri-117VAC, sec-24VAC, 250mA \$6.95
 - PP2-SW Panel-mount potentiometers & knobs 1-1K B-taper & 1-10K w/sw. \$5.95
 - SS14-SW IC's (7 pcs, diodes (4 ea.), regulators (2 ea.) & heat sink (1 ea.) \$29.95
 - CE9-SW Electrolytic capacitor kit (9 ea.) \$5.95
 - CC33-SW Ceramic disc capacitors: 50 WV (33 pcs) \$7.95
 - C1-SW Variable ceramic trimmer capacitors 5-65 pF (6 pcs) \$5.95
 - L4-SW Coil kit: 2 ea. 18uH 1 ea. 22uH inductances pre-wound and 1 ea. T37-12 ferrite toroid core with 6 ft. #26 wire \$5.00
 - ICS-SW IC sockets: tin inlay, solderated, 5 ea. 8-pin & 2 ea. 14-pin \$1.95
 - SR-SW Speaker & enclosure with pre-punched backboard \$14.95
 - MISC. Miscellaneous kit includes hardware, 6-32 & 8-32 screws, bolts, wire, ant. terminals, DPDT switch, fuseholder, etc. \$9.95
- When ordering all items 1 thru 14 total price is \$139.95

- STVA-1 Yagi antenna, 7 element, 75ft. Channels 42-54 11.5 dB gain \$9.95
 - COAX 75ft. coax cable, RG759U-11c per foot
 - F-59 Coax connectors: 30c ea
 - Mt-1 Special UHF 75-300ft matching transformer \$1.45
 - A-1 Indoor VHF-UHF antenna amplifier 300ft in-out, 13 dB gain \$19.95
- Min. order amount is \$19.95, add 10% shipping & handling Over \$40 add 5% shipping & handling. Catalog send \$1.00. Mail Orders Only!
Simple Simon Electronics Kit, California Orders send to: 3871 South Valley View Suite 12, Las Vegas, Nevada 89108 Other orders send to: 11850 Hawthorne Blvd., Hawthorne, CA 90250
Visa-Mastercharge OK, Telephone 213-675-3347

Satellite TV

Now!

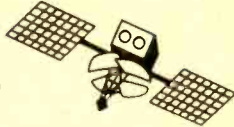

Receive 200 Channels Anywhere!

That's what the ads say. Is it true? Well, yes and no. You can receive 75 to 200 channels, but not just anywhere. Those ads are written to sell expensive equipment, which you might not even be able to use. Only a complex computer analysis of your location can tell for sure.

We offer an independent computer analysis of your location, anywhere in the world, covering more than 100 different satellites! Our computer will tell you which satellites you can receive, where to point your antenna, and how strong the signals are likely to be. Know for sure BEFORE you spend your money on equipment.

The cost? Only \$19.95 postpaid. [Air Mail \$2.00 extra]. We can save you hundreds - even thousands - of dollars. Send check, money order, or charge in on VISA or Master Card. Call Toll Free! 24 hrs. 800-228-2606 In Nebraska, 800-642-8777

Satellite Computer Service Dept. RE, 1808 Pomona Drive Las Cruces, NM 88001 U.S.A.

CIRCLE 66 ON FREE INFORMATION CARD

SEPTEMBER 1981

Electronic Tool Catalog



- Breadboarding Kits
- Digital Multimeters
- Oscilloscopes
- Test Probes
- Tool Kits
- Soldering Supplies
- Solder Suckers
- Precision Hand Tools
- Wire Strippers
- Bench Lamps
- Wire Wrap Tools
- Ultrasonic Cleaners
- Printed Circuit Holders
- And Much More

If you build or tinker with electronics you can't afford to be without this complete buying guide. Features hundreds of hard-to-find products for building and testing electronic equipment. These are quality products used by big electronics companies—not just ordinary tools. Contains hundreds of photos, detailed descriptions, and pricing. Most items are discounted at big savings. Everything is easy to order by phone or mail, ready for immediate delivery, and fully guaranteed. VISA and Master Card accepted.

Clip and mail coupon today.
Coupon missing? Send \$2.00, refundable with first order, to:

Contact East, Dept. 0073
P.O. Box 160, 7 Cypress Dr.
Burlington, MA 01803

Rush me your catalog
 Enclosed is \$2.00
 (Refundable with first order)

Name _____
 Address _____
 City _____
 State _____ Zip _____

Clip and mail to:
Contact East, Dept. 0073
P.O. Box 160, 7 Cypress Dr.
Burlington, MA 01803

ADVERTISING INDEX

RADIO-ELECTRONICS does not assume any responsibility for errors that may appear in the index below.

Free Information Number	Page
25	AMC, Sales.....112
—	ATV Research.....101
37	Active Electronics.....99
3	Advanced Computers.....110-111
—	Advance Electronics.....24-25, 32, 36
38	Albia Electronics.....23
48	All Electronics.....123
12	American Antenna.....Back Cover
49	Ancrona.....119
65	Antenna Specialist.....91
47	B & K Precision.....86
—	Karel Barta.....101
—	Bullet Electronics.....124
10	CFR Associates.....118
—	CIE, Cleveland Institute of Engineering.....38-41
17	Cambridge Learning.....26
30	Central Point Software.....126
18	Channellock.....22
27	Chaney Electronics.....112
—	Command Productions.....98
68	Communications Electronics.....94
62	CompuTech.....92
76	Components Express.....127
51	Concord Computer Products.....126
—	Contact East.....128
—	Cook's Institute.....98
28	Jan Crystal.....95
—	Dage Scientific.....100
72	Diamond-Back.....108
9	Digi-Key.....105
—	Edu-Calc.....83
14	Electronic Book Club.....13
—	Electronic Technology Today.....83
67	Electronic Specialist.....123
—, 74	Etc.....104, 127
—	Fanon.....128
—	Fordham.....123
4	Formula International.....106-107
39	Global Specialties.....79
—	Global TV.....98
53	Godbout.....112
—	Grantham College of Engineering.....89
64	Hal-Tronics.....100
40	Hameg Inc.....93
15, —, 22	Heath.....Cover 3, 34-35, 75
—	High Frontier.....98
69	Hitachi.....16
—	Hobby Robotics.....101
—	Information Unlimited.....128
—	International Communications Co.....98
—	International Circuit Company.....128
58	International Electronics.....104
59	JDR, Microdevices.....120-121
2	Jameco.....102-103
33	Javan.....122
46	Keithley Instruments Inc.....81
29	H.J. Knapp.....108
70	MTI.....94
—	McGee's Radio.....108
—	McGraw-Hill Book Club.....18-21
—	McKay Dymek.....128
23	Meshna Inc.....118
20	Micro Ace.....124
—	Micro Management.....100
—	Micro-tenna Associates.....128
—	Monarchy Engineering.....112
60	Mountain West.....90
61	Mouser Electronics.....95
—	NRI Schools.....8-11
—	NTS Schools.....28-31
—	Netronics.....80
52	Non-Linear Systems.....37
34	Normack.....87
41	Omega Sales.....15
26	Paccom.....88
35	Pac tec.....27
54	Page Digital.....114-115
55	Priority One.....116-117
16, 42	Poly Paks.....88, 118
—, 75,	RC A.....33, 42, 77
5	Radio Shack.....109
7	Ramsey Electronics.....125
32	SCR.....89
—	Sabtronics.....2
19	H.W. Sams.....87
66	Satellite Computer Services.....127
73	Shure Brothers.....Cover 2
—	Simple Simon.....127
13	Simpson.....73
36	Skyscan.....1
43	Solid State Sales.....122
—	Spacecast.....98

44	A.W. Sperry Instruments Inc.....7
11	Surplus Electronics.....113
78 & 79	Triplet.....97
8	Vaco.....5
24	Vector Electronics.....27
63	Vermont Electronics.....123
6	Viz.....17
—	Wersi.....90
45	Weston.....89

FANON

BLAZING NEW TRAILS IN ELECTRONICS SINCE 1949

FANON/COURIER CORPORATION, 990 South Fair Oaks Avenue, Pasadena, California 91105. TEL: (213) 799-9161 TELEX: 07-5448

AMAZING ELECTRONIC PROJECTS and PRODUCTS:
 Lasers Super Powered, Burning Cutting, Rifle, Pistol, Pocket. See in Dark—Shotgun Directional Mike—Unscramblers—Giant Tesla—Stunwand—TV Disrupter—Energy Producing, Surveillance, Detection, Electrifying, Ultrasonic, CB, Auto and Mech. Devices, Hundreds More—All New Plus INFO UNLTD PARTS SERVICE, Catalog \$1. Information Unlimited, Dept. R8 Box 716 Amherst, N.H. 03031.

MICROWAVE HORN ANTENNA KIT

1.7-26 GHz Frequency Range 17-19 db Gain Kit w/Assembly Instructions \$39.95*
 Down Converter Board \$19.95 (w/Antenna Kit \$14.95)
 Parts Kit for Board \$29.95* (w/Antenna or Board \$24.95)
 Complete Package (Antenna, Board & Parts Kit) \$79.95



MICROTENNA ASSOCIATES

2335 South 2300 West, Salt Lake City, Utah 84119
 Check or M.O. only — Allow 2-4 Weeks Delivery (Cost includes shipping)
 *Utah Residents Please Add 5% Sales Tax

PRINTED CIRCUIT BOARDS

We manufacture PC Boards from your artwork.
 — we can handle any size order
 — only 25¢ per sq. in. single side - 30¢ double side
 — drilling and tin plating at no charge
 Send check or money order to:

International Circuit Company

903 Tyler Avenue, Dyer, Indiana 46311
 (219) 865-9925

NEED A COMPACT ANTENNA?

McKAY SETS THE STANDARD

with the DA100D Outdoor Antenna and the DA9-DL4 Combination Indoor Loop Antenna

For Specs and details contact dealers:

HARVEY RADIO New York City
 HENRY RADIO Los Angeles CA
 BARRY ELECTRONICS New York City
 GILFER ASSOCIATES Park Ridge New Jersey
 ELECTRONIC EQUIPMENT BANK (D.C. area) Vienna VA
 BRIDGEWATER CUSTOM SOUND Harvey, ILL
 AUDIO PERFECTION Bloomington MINN
 STANDARD SUPPLY CO. Salt Lake City Utah
 THE BASE STATION Concord CA
 J-MAR ELECTRONICS Toronto Canada

800/854-7769 Local 714/621-6711
 except CA, Alaska, Hawaii TWX 910-581-4990



McKAY DYMEK COMPANY
 111 S. College Ave. P.O. Box 5000
 Claremont CA 91711 U.S.A.



Now the stars are within your reach

Movie Stars Concert Stars Sports Stars



Your favorite stars are coming off the satellites right now in one of the greatest selections of family and adult entertainment ever offered. And now there's a new satellite receiver system that puts it all within your reach - at a price that's within reach.

The new Heathkit Earth Station

It includes a 3-meter Satellite Antenna with a single-axis adjustable mount that lets you direct your antenna to receive signals from the entire satellite arc. It's a heavy-duty, commercial-quality antenna, made by Scientific-Atlanta and designed for long, reliable performance.

Special Low-Noise Amplifier and Down-Converter converts signals to 500 MHz band for transmission on ordinary TV cable.

The Receiver features electronically-synthesized tuning for stable, drift-free reception, and 24 channel selections for a broad variety of programming. It even includes a special Zenith Space Command Remote Control so you can change programs without leaving your easy chair.

Special Earth Foundation Kit anchors your antenna firmly to withstand winds of up to 100 mph.

Unique Site Survey Kit

You can trust Heath to do it right. The first step in establishing your station is the purchase of a special Site Survey Kit that includes everything you need to determine a clear line-of-sight to the satellites. So you know your location is correct before you buy the Station.

Easy-to-follow, step-by-step assembly

Like all Heathkit products, the Satellite Earth Station includes a clearly written manual that guides you every step of the way through assembly and installation. And over-the-phone assistance is always available.

For complete details and prices on the Heathkit Earth Station and 400 other electronic kits for home, work or play, send today for the latest free Heathkit Catalog or visit your nearby Heathkit Electronic Center.*



Send for free catalog

Write to Heath Co., Dept. 020-816,
Benton Harbor, MI 49022

Visit your Heathkit Store

Heathkit products are displayed, sold and serviced at 56 Heathkit Electronic Centers in the U.S. See your telephone white pages for locations.



*Heathkit Electronic Centers are units of Veritechnology Electronics Corporation.

Viewing of some satellite TV channels may require the customer to obtain permission from, or make payments to, the programming company. The customer is responsible for compliance with all local, state and federal governmental laws and regulations, including but not limited to construction, placement and use. For use only in Continental U.S. This device has not been approved by the Federal Communications Commission. It is not, and may not be, offered for sale or lease, or sold or leased, until the approval of the FCC has been obtained.

Heathkit

CIRCLE 15 ON FREE INFORMATION CARD

www.americanradiohistory.com

IF YOU OWN A RADIO, THIS MICROPHONE WILL LET YOU TRANSMIT FURTHER AND CLEARER OR WE'LL GIVE YOU YOUR MONEY BACK!



Guaranteed to out perform any mic on any radio!

A speech processor microcircuit, designed by us, that eliminates splatter, boosts power and recharges its own battery. A patented American invention made in an American town.

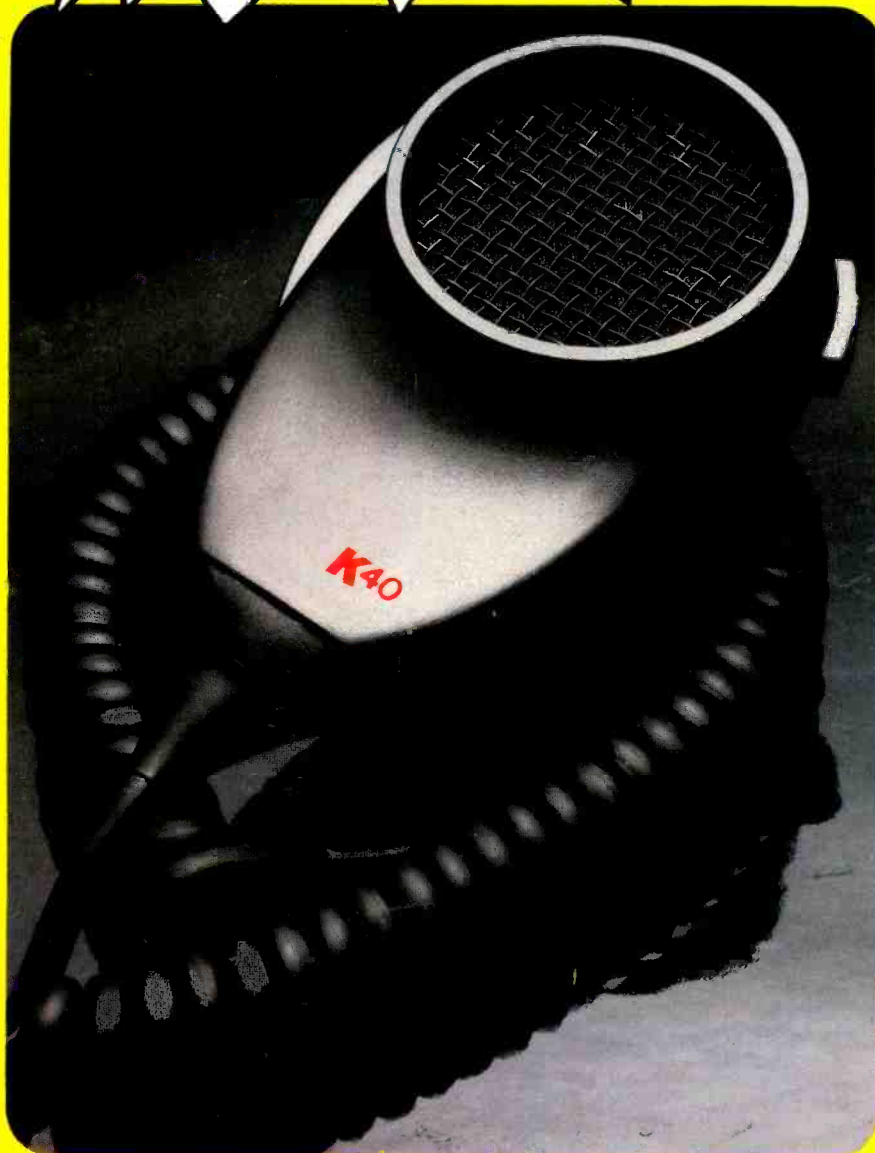

CHECK OUT THE EXCLUSIVE FEATURES!



- CLIPS ANYWHERE
- PROCESSES SPEECH WITH COMPUTER CIRCUIT
- SOUND SENSITIVE 2 INCHES OR 2 FEET
- NOISE CANCELLING
- TWO MICS WITH ONE SWITCH
- FRESH CHARGE WITH NO BATTERIES

YOUR DOUBLE GUARANTEE

GUARANTEE I:

The K40 Speech Processor is guaranteed to outperform any microphone it replaces or return it for a complete and full refund within 7 days from the K40 Dealer that installed and tuned it.

GUARANTEE II:

Unconditionally guaranteed for 12 months. Guaranteed against cracking, chipping, or rusting. Guaranteed against mechanical failure. Guaranteed against electrical failure. No exclusions. No gimmicks. For a full 12 months.

\$44.⁵⁰ Suggested Retail

AMERICAN ANTENNA
ELGIN, ILLINOIS 60120
© COPYRIGHT AMERICAN ANTENNA

... Sold exclusively by **3500** American **K40** Dealers throughout the U.S. & Canada.

CIRCLE 12 ON FREE INFORMATION CARD

www.americanradiohistory.com